



**BIBUS ENDÜSTRİYEL A.Ş.**

İkitelli OSB Bedrettin Dalan Bulvarı Vip Plaza  
Kat:2 No:43 Başakşehir/İstanbul

Tel. 444 20 38  
Fax 0212 249 88 34

info@bibus.com.tr  
www.bibus.com.tr



BIBUS - SMART OFFICE & HOME SOLUTION - Standing Desk Systems,  
Lifting TV Base, Lifting Cabinet Bases, Lifting Column, Linear Actuators / 01.2023)



**SMART OFFICE & HOME SOLUTION**

Standing Desk Systems, Lifting TV Base,

Lifting Cabinet Bases, Lifting Column, Linear Actuators

[www.bibus.com.tr](http://www.bibus.com.tr)

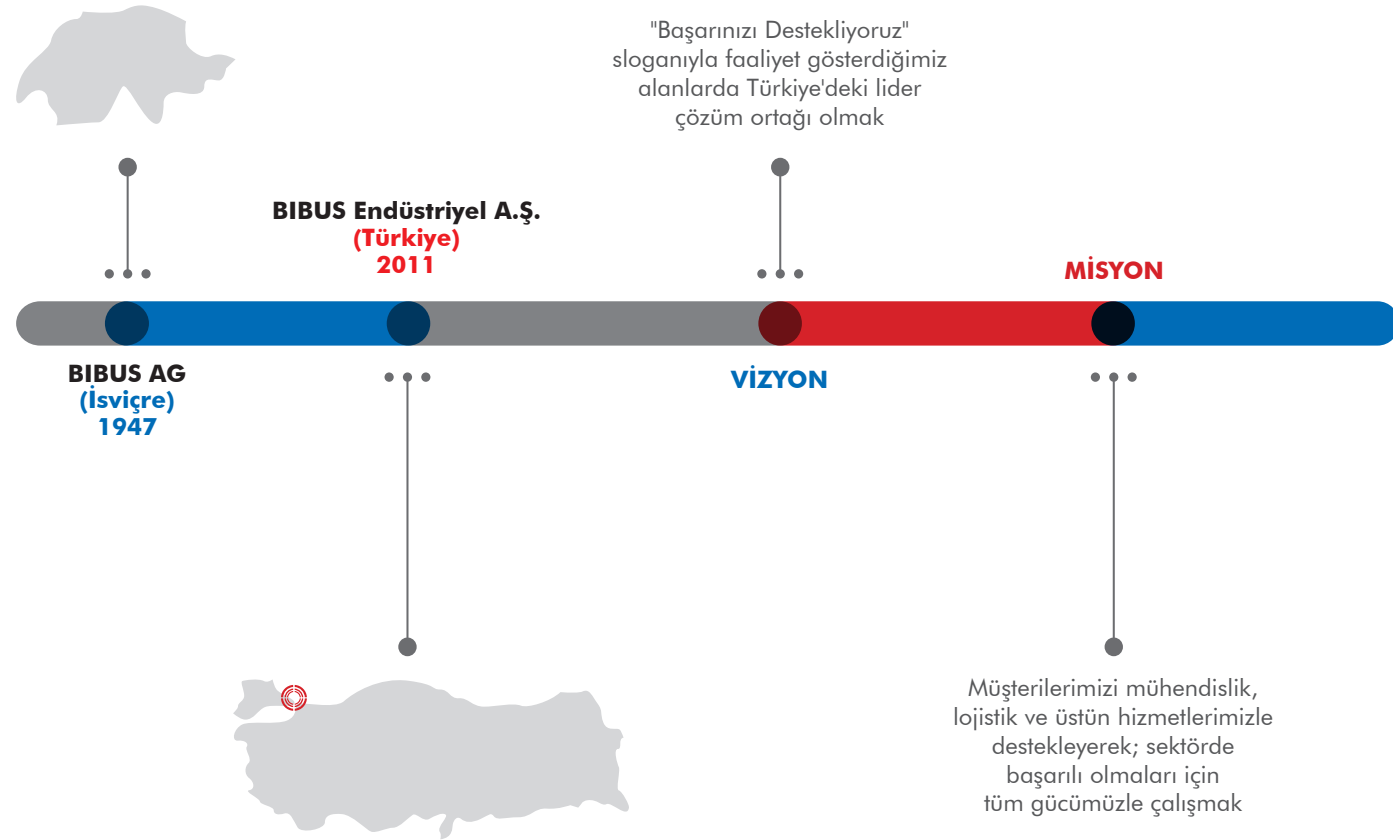

## BIBUS Türkiye

Başarınızı destekliyoruz

TEK TEDARİKÇİ • TEK TEMAS • TEK SORUMLULUK

BIBUS Holding AG, Avrupa ve Asya'daki lokasyonları ile birlikte İsviçre merkezli bir şirkettir. 1947 yılında Dipl. Ing. Hans Bibus tarafından, çelik ticareti amacı ile kurulmuş olan şirket; teknoloji, malzeme ve elektronik alanlarında faaliyet gösteren ilerici bir şirketler grubuna dönüşmüştür. Güvenilirliği ve yüksek kalite standartları sayesinde, yüksek kaliteli endüstriyel ürünler, bileşenler ve sistem çözümleri için pazarda lider tedarikçi ve hizmet ortağı olarak kendini kanıtlamıştır.

BIBUS Holding AG, iç ve dış ortaklarıyla birlikte büyür ve başarılarını güçlü bir şekilde destekler. Tüm şubeler, grubun uzmanlığına ve kaynaklarına erişebilir. Kendileri için, mühendislik, lojistik ve hizmet segmentlerindeki özel yerel yetkinlikleri ile müşterilerimizin ve tedarikçilerimizin performansına katkıda bulunurlar.

Ortaklarımız, genel müdürlerimiz ve çalışanlarımızla birlikte, "Başarınızı destekliyoruz" ilkemize dayanarak uzun vadeli istikrarlı bir geleceğe bağlıyız.

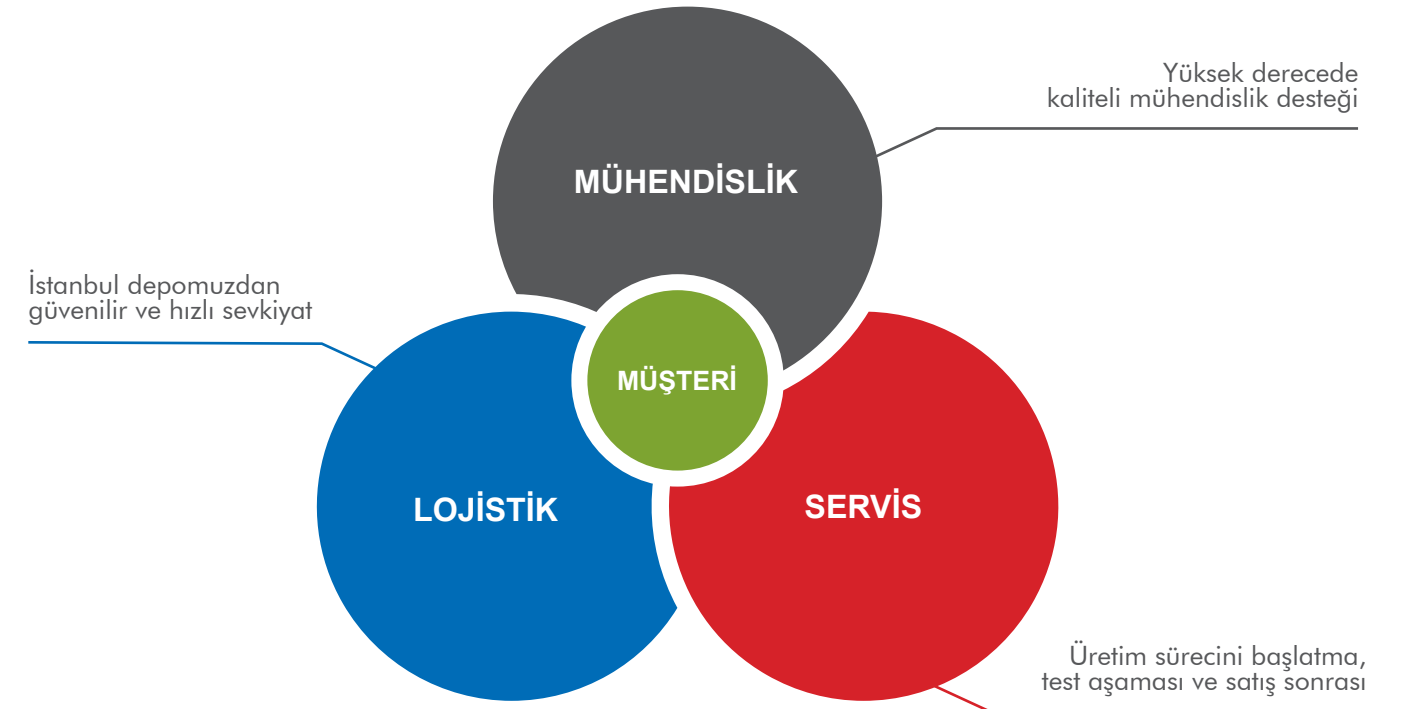

[www.bibus.com.tr](http://www.bibus.com.tr)



## CERTIFICATION

BIBUS have passed ISO9001, ISO14001, ISO27001, OHSAS18001 and other management systems, and our products have passed UL, CE, ROHS, SAA, PSE, KC, BIFMA and other international certifications.





## BBS35TS-R12S

DOUBLE-MOTOR OFFICE DESKS

SURFACE COLOR



Black / White / Silver

Accept color customization

TECHNICAL PARAMETER

Height (mm)	685 ~ 1185	Width (mm)	1080 ~ 1800
Speed (mm/s)	32	Noise (dB)	≤50
Load Capacity (N)	1200		

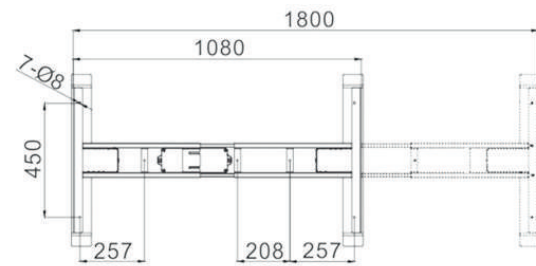
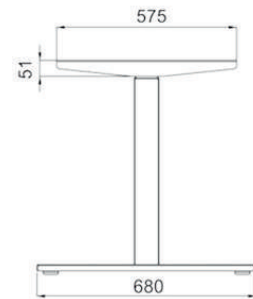
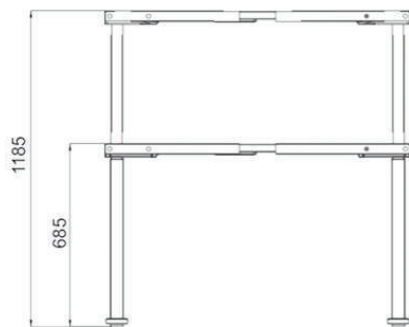

## BBS35TS-R13S

DOUBLE-MOTOR OFFICE DESKS

SURFACE COLOR



Black / White / Silver

Accept color customization

TECHNICAL PARAMETER

Height (mm)	575 ~ 1255	Width (mm)	1080 ~ 1800
Speed (mm/s)	32	Noise (dB)	≤50
Load Capacity (N)	1200		

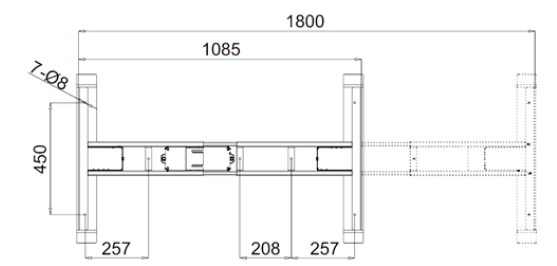
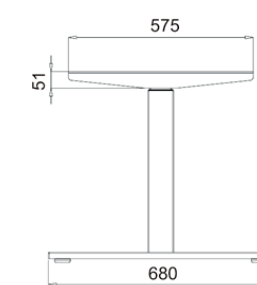
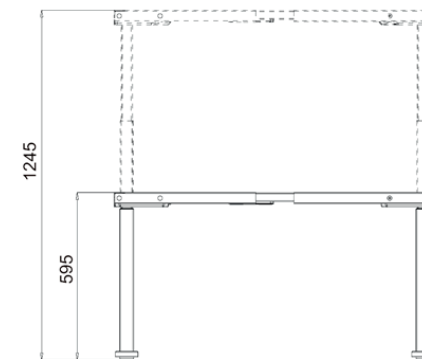





## BBS35TF-R13S-2

FOUR-MOTORS OFFICE DESKS

### SURFACE COLOR



Black / White / Silver

Accept color customization

### DETAIL DISPLAY

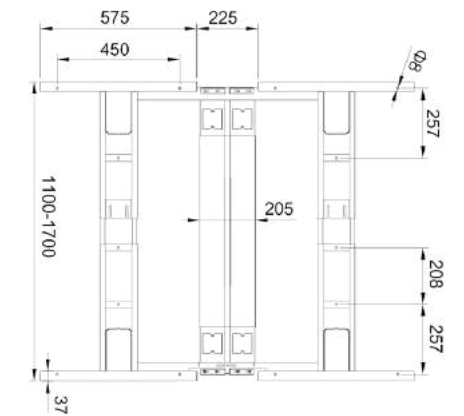
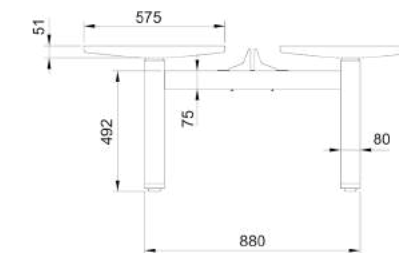
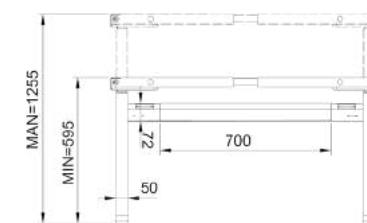
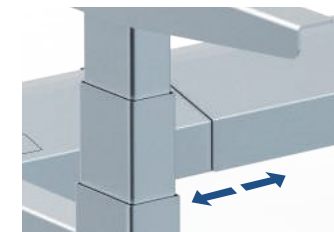

### TECHNICAL PARAMETER

↓ Height (mm)	↔ Width (mm)
595 ~ 1255	1100 ~ 1700
⚡ Speed (mm/s)	🔊 Noise (dB)
40	<50
⚖ Load Capacity (N)	
1250	







## BBS35TT-R13S-120°

THREE-MOTORS OFFICE DESKS

### SURFACE COLOR



Black / White / Silver

Accept color customization

### TECHNICAL PARAMETER

↕ Height (mm)

595 ~ 1245

⚡ Speed (mm/s)

40

⚖ Load Capacity (N)

1500

↔ Width (mm)

1080 ~ 1800

🔊 Noise (dB)

<50

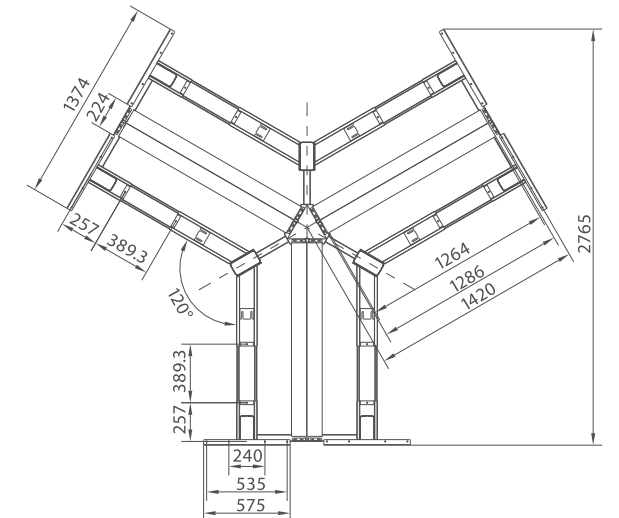
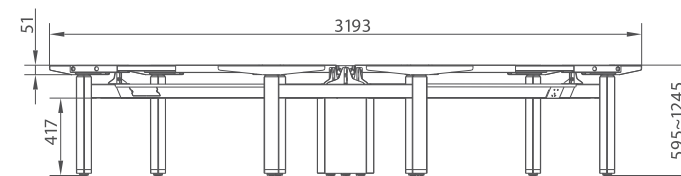
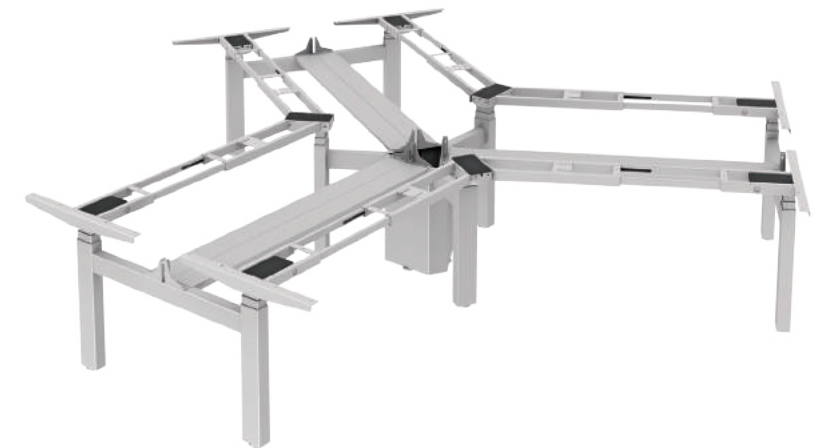





**BBS35TF-R13S-4**  
FOUR-MOTORS OFFICE DESKS

SURFACE COLOR



Black / White / Silver

-  
Accept color customization

DETAIL DISPLAY

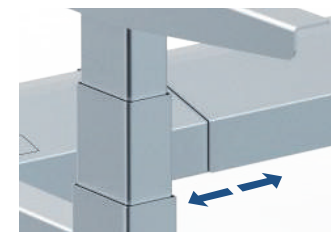

TECHNICAL PARAMETER

↕ Height (mm)	↔ Width (mm)
595 ~ 1255	1100 ~ 1700
⚡ Speed (mm/s)	🔊 Noise (dB)
40	<50
👤 Load Capacity (N)	
1250	

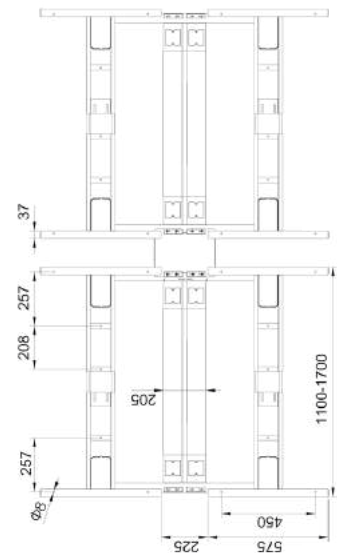
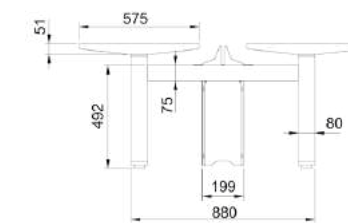
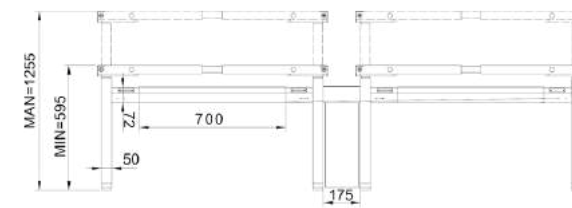



### BBS35TT-R13R-90°



Width (mm)  
1080 ~ 1800

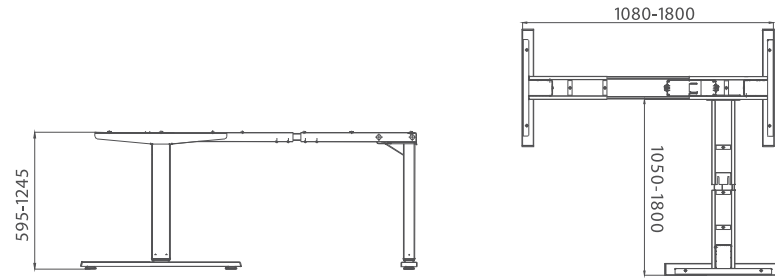

### BBS35TT-C13S-120°



Width (mm)  
1050 ~ 1900

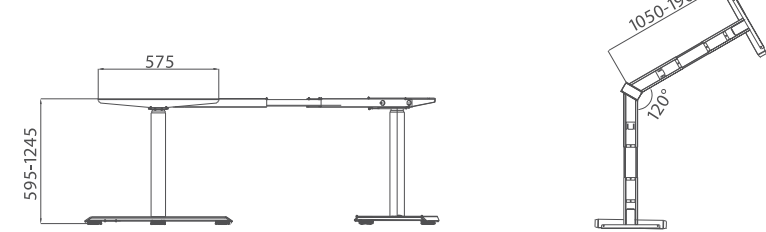

### BBS35TT-R12S-180°



Width (mm)  
1995 ~ 2995

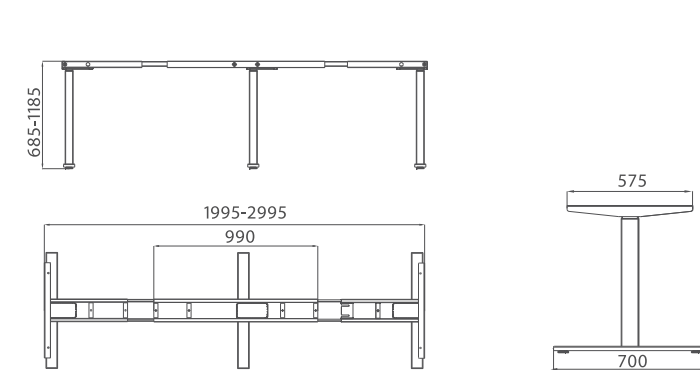

### BBS35TO-S33S SINGLE-MOTOR ADJUSTABLE DESKS

#### SURFACE COLOR



Black / White / Silver

-  
Accept color customization

#### TECHNICAL PARAMETER

Height (mm)	Noise (dB)
585 ~ 1235	<50
Speed (mm/s)	Load Capacity (N)
40	800

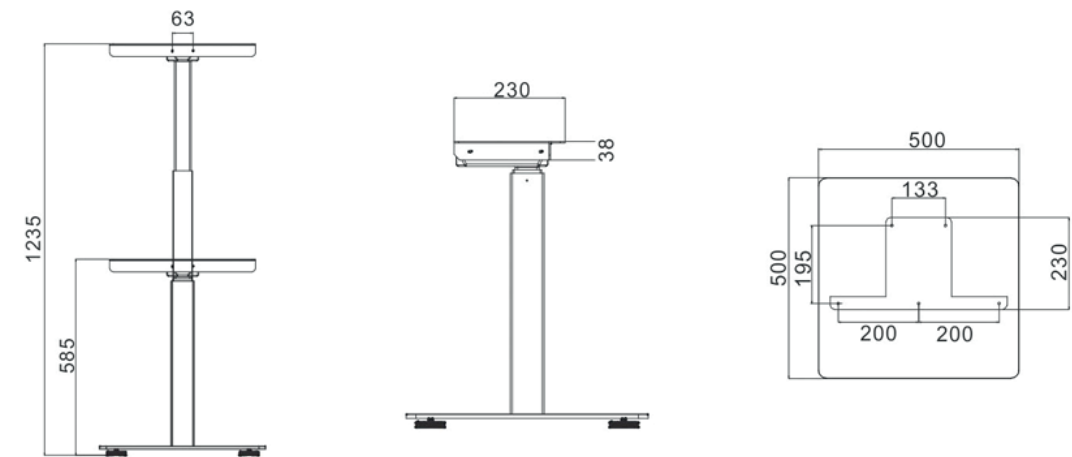



## 3/STAGE LIFTING COLUMN

TECHNICAL PARAMETER

Stroke (mm)

650

Height (mm)

560 ~ 1210

Load Capacity (N)

800

Speed (mm/s)

40

BBS36DR1-3-S

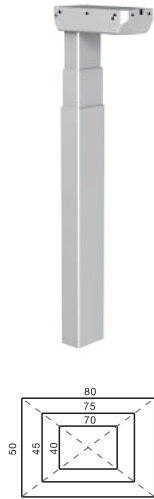

BBS36DR1-3-R



BBS36DR2-3-S



BBS36DR3-3-S

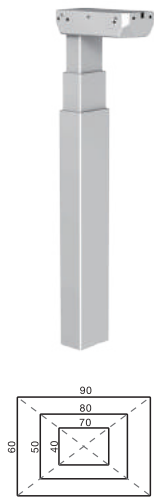

BBS36DR4-3-S

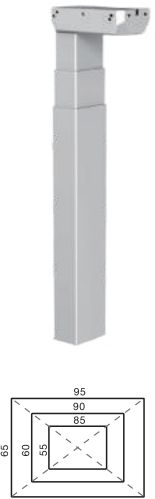

BBS36DR6-3-S

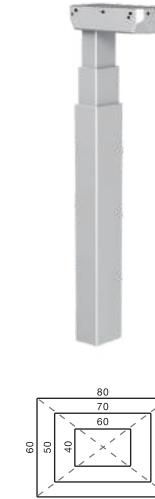

BBS36DS1-3-S

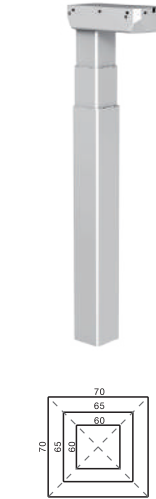

BBS36DS1-3-R



BBS36DS3-3-S

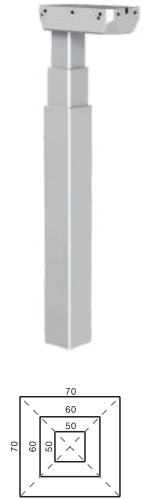

BBS36DS4-3-S

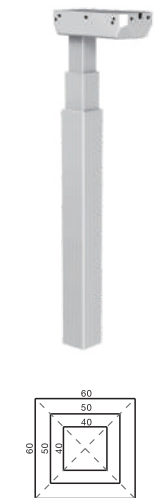

BBS36DS4-3-R



BBS36DS5-3-S

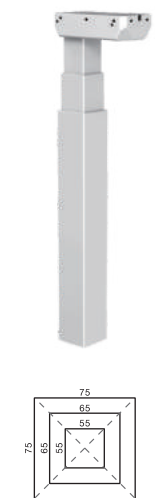

BBS36DS9-3-S

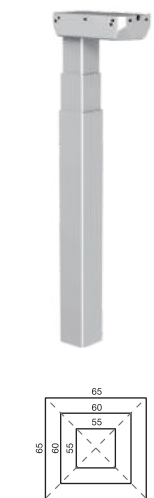

BBS36DC1-3-S



BBS36DC1-3-R



BBS36DE1-3-S







BBS36DE2-3-S





## 2/STAGE LIFTING COLUMN

### TECHNICAL PARAMETER

 Stroke	(mm)
500	
 Height	(mm)
650 ~ 1150	
 Load Capacity	(N)
800	
 Speed	(mm/s)
32	

BBS36DR1-2-S

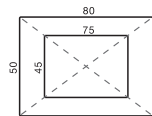

BBS36DR1-2-R

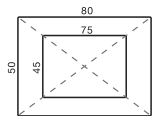

BBS36DS5-2-S

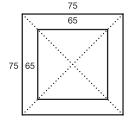

BBS36DS9-2-S

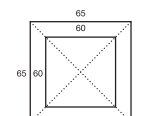

BBS36DC1-2-S

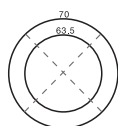



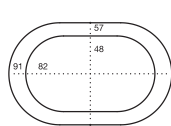

BBS36DE1-2-S



## OTHER LIFTING COLUMN

### TECHNICAL PARAMETER

 Stroke	(mm)	 Load Capacity	(N)	 Speed	(mm/s)
660		800		40	
 Height	(mm)	 Section size	(mm)		
518 ~ 1178		55x85 / 60x90 / 65x95			







BBS36ZR4-3-S



BBS35EN-2K









### TECHNICAL PARAMETER

 Stroke	(mm)	 Load Capacity	(N)	 Speed	(mm/s)
400		1500		30	
 Height	(mm)	 Bending moment	(NM)	 Section size	(mm)
650 ~ 1050		dynamic: 500N / static: 1000		145x112 / 164x131	

BBS35EA-3A



### TECHNICAL PARAMETER

 Stroke	(mm)	 Load Capacity	(N)	 Speed	(mm/s)
350		2000		16	
 Height	(mm)	 Bending moment	(NM)	 Section size	(mm)
325 ~ 675		dynamic: 250N / static: 500		175x140	







## OTHER LIFTING COLUMN

BBS36ZS8-3-S







### TECHNICAL PARAMETER

 Stroke (mm)	 Load Capacity (N)	 Speed (mm/s)
650	800	40
 Height (mm)	 Section size (mm)	
560~ 1210	70x70 / 65x65 / 60x60	

BBS36H2



### TECHNICAL PARAMETER

 Stroke (mm)	 Load Capacity (N)	 Speed (mm/s)
500	500	30
 Height (mm)		
860		



## WIRE MANAGEMENT



BBSXC01

- Length: 762mm
- Width: 99,8mm
- Height: 74,5mm



BBSXC02

- Length: 950mm
- Width: 205mm
- Height: 73,5mm



BBSXC03

- Length: 1351mm
- Width: 200mm
- Height: 72mm



BBSXC04

- Length: 1264mm
- Width: 192,4mm
- Height: 71,8mm



BBSXC05

- Length: 1000mm
- Width: 136mm
- Height: 18mm



BBSXC06

- Length: 900mm
- Width: 173mm
- Height: 60mm

## CONTROL BOX



BBS35N1



BBS35N2



BBS35N3



BBS35N4



BBS35NS1



BBS35NS2



BBS35N2C



BBS35M

## CONTROL BOX + HANDSET



BBS35M1



BBS35M3



BBS35M6



BBS35M11C



BBS35M12B



BBS35M12C

## HANDSET



BBSHT35K

- 4 Memory Buttons
- Black
- LED



BBSHT35K9

- 4 Memory Buttons
- Black
- LED
- USB Charger



BBSHT35K11

- 3 Memory Buttons
- Water-proof on the Front Side
- Silicone Button
- 90° mounting angle
- Black / White / Grey / Green



BBSHT35K24A

- Up & Down Button
- Seesaw Button



BBSHT35K24B

- Up & Down Button
- Seesaw Button
- LED



BBSHT35K24C

- 3 Memory Buttons
- Seesaw Button
- LED
- USB Charger



BBSHT35K24D

- 3 Memory Buttons
- Seesaw Button
- LED
- Two Speed
- USB Charger



BBSHT35K24S

- 3 Memory Buttons
- Seesaw Button
- LED
- Two Speed
- USB Charger



BBSHT35K23

- 2 Memory Buttons
- Acrylic Material
- With different back light color options
- Sedentary Reminder
- OLED



## HANDSET



BBSHT35K26A

- Up & Down Button
- Top Mounted
- Multiple colors
- Silicone Button



BBSHT35K26B

- Up & Down Button
- Top Mounted
- Multiple colors
- LED
- Silicone Button



BBSHT35K26C

- 3 Memory Buttons
- Top Mounted
- Multiple colors
- LED
- Silicone Button



BBSHT35K26A

- Up & Down Button
- Side Mounted
- Multiple colors
- Silicone Button



BBSHT35K26B

- Up & Down Button
- Side Mounted
- Multiple colors
- LED
- Silicone Button



BBSHT35K22

- 3 Memory Buttons
- Water-proof on the Front Side
- Silicone Button
- 34° mounting angle
- Black / White / Grey / Green



BBSHT35K40C

- 4 Memory Buttons
- Side Mounted
- LED
- Silicone Button



BBSHT35K55C

- 4 Memory Buttons
- Side Mounted
- LED
- Silicone Button



BBSHT35K20

- Operate by tilting for up and down
- Acrylic Material
- With different back light color options
- Shapes can be customized

## HANDSET



BBSHT35K50A

- Operate by tilting for up and down
- Indicator lights



BBSHT35K50B

- Operate by tilting for up and down
- LED



BBSHT35K50C

- 2 Memory locations
- Operate by tilting for up and down
- OLED
- Sedentary Reminder
- Child lock function



BBSHT35K52C

- 2 Memory Buttons
- LED
- DIY keyboard keys
- Light adjustment



BBSHT35M13

- 3 Memory Buttons
- Touch Screen
- LED
- 34° or 90° mounting angle



BBSHT35L

- Up & Down Button
- Black



BBSHT35M6

- 3 Memory Buttons
- Touch Screen
- OLED
- Operate by rotating for up and down
- Sedentary Reminder

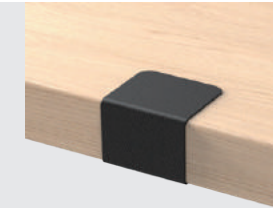

BBSHT35M33A

- Made of leather
- Up & Down Button



BBSHT35M33C

- Made of leather
- Up & Down Button
- 2 Memory locations

## HANDSET



BBSHT35K32C

- 3 Memory Buttons
- Water-proof on the Front Side
- Silicone Button
- LED



BBSHT35K33C

- 3 Memory Buttons
- Water-proof on the Front Side
- Silicone Button
- LED



BBSHT35M18C

- 3 Memory Buttons
- Water-proof on the Front Side
- Touch Screen
- Light Wake
- LED



BBSHT35M19C

- 3 Memory Buttons
- Water-proof on the Front Side
- Touch Screen
- Light Wake
- LED

## ACCESSORIES

FAST CHARGER



BBSB35N7

- Maximum output power: 65W
- Has TypeA and TypeC charging ports

2.4G WIRELESS ADAPTER



BBSP35N-2.4G

- Input power: 5V
- Remote control frequency: 2.4GHz
- Transmission distance: 8M

LITHIUM BATTERY



BBSP35PA-B-3

- Mobile office
- Low power consumption
- USB charger
- Safe & fast charging

BLUETOOTH ADAPTER

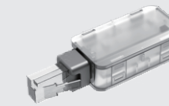

BBSP35N-BLT

- Plug in the Bluetooth receiver box on the control box, then turn on the Bluetooth and control the adjustable table through the APP on mobile phone

CABLE CHAIN



BBS-TSXG01

- Accessories of standing desk for cable management.
- Size: 90mm\*120mm\*1400mm
- Color: Black, White, Chroma
- Material: ABS (Black/White) / PP (Chroma)

WIFI ADAPTER



BBSP35N-Wifi

SIX AXIS SENSOR



BBSB35N-6AXIS

- Intelligent anti-collision accessories
- High sensitivity, stable operation

WIRELESS CHARGER



BBSP35WA-A

- Power the phone wirelessly
- Under the desktop

Workstation Reservation Box



BBSP35NA

- It is used in the station reservation system which can realize functions such as non-sensing check-in, NFC check-in, light prompt, etc.



## ACTUATORS



BBS35N

- Max load capacity(N):20
- Max speed at load(mm/s):12
- Max IP grade:IPX4



BBS35N1

- Max load capacity(N):100
- Max speed at load(mm/s):7
- Max IP grade:IPX4



BBS35N3

- Max load capacity(N):100
- Max speed at load(mm/s):5
- Max IP grade:IPX4



BBS35L

- Max load capacity(N):4000
- Max speed at load(mm/s):30
- Max IP grade:IPX4



BBS35J1

- Max load capacity(N):2000
- Max speed at load(mm/s):14,5
- Max IP grade:IPX4



BBS35W1

- Max load capacity(N):1000
- Max speed at load(mm/s):20
- Max IP grade:IPX4



BBS35W2

- Max load capacity(N):3000
- Max speed at load(mm/s):16
- Max IP grade:IPX4

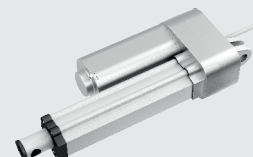

BBS35W2-2

- Max load capacity(N):3000
- Max speed at load(mm/s):16
- Max IP grade:IPX6



BBS35W5

- Max load capacity(N):3000
- Max speed at load(mm/s):11
- Max IP grade:IPX8

## ACTUATORS



BBS35N6

- Max load capacity(N):1200
- Max speed at load(mm/s):10,5
- Max IP grade:IPX6



BBS35N8

- Max load capacity(N):2500
- Max speed at load(mm/s):9,6
- Max IP grade:IPX6



BBS35L6

- Max load capacity(N):2000
- Max speed at load(mm/s):63
- Max IP grade:IPX4



BBS35L19-A

- Max load capacity(N):100
- Max speed at load(mm/s):9
- Max IP grade:IPX4

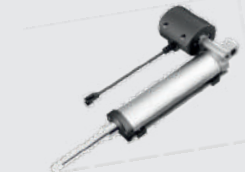

BBS35L19-B

- Max load capacity(N):100
- Max speed at load(mm/s):9
- Max IP grade:IPX4



BBS35L19-C

- Max load capacity(N):100
- Max speed at load(mm/s):9
- Max IP grade:IPX4



BBS35TM2

- Max load capacity(N):1000
- Max speed at load(mm/s):14
- Max IP grade:IPX4



BBS35ESN-2 ~ BBS35ES-2

- Max load capacity(N):1000 ~ 6000
- Max speed at load(mm/s):11 ~ 21
- Max IP grade:IPX4



BBS37B1

- Max load capacity(N):500
- Max speed at load(mm/s):30
- Max IP grade:IPX4

### Smart cabinet lifting

Making Full Use of Spaces of Overhead Cabinet and Making Items Touchable Easily

#### Features

- Max load capacity(N):500
- Intelligent touching control, Stable motion with just a finger.
- Built-in remote controller BBSHR35R2. The cabinet would go up and down when push corresponding button.
- Sensitive reaction when encountering an obstacle during motion.



Optional Matching: BBSHR35R2





### Deskboard expanding

Pretty and Harmonious Whole Appearance and Available for More Loaded Items

#### Features

- Taking latest metallic materials of low density, making it light and small. Color of silver gray shows a sense of future.
- Thrust upgrades up to 3000N, and it can be adjusted according to demand.
- Excellent configuration promotes nearly no noise during motion, meeting the top standards of industrial design.
- Few requirements for installation space, and wide range of application.



Matching Control Box: BBSB35NS1



Optional Matching: BBSHR35R1





### TTM lifting

Keep Sitting Comfortable by Adjustable Height

#### Features

- Optimized design, the profiles are much more smooth of senses.
- Surface dealing of electrophoresis technology, with a sense of intelligence.
- Compact structure shows finest industrial aesthetics, smaller installing dimensions makes a sensitive motion.
- Safe and sound after international rollover resistance tests. A great choice for many applications.



Matching Control Box: BBSB35Q



Optional Matching: BBSHR35F





### TV lifting system

Height Adjustable According to Your Visual Range

#### Features

- Max load capacity(N): 600
- Remote control or manual
- Height adjustable
- Inversion installing



The top fixing iron plate can be added when upside-down, which is convenient to fix the top mounting plate.



A pulley can be added to help open the top plate of the TV cabinet.

**BBS35VT-650**  
Stroke length(mm): 650  
Retracted Length(mm): 570

**BBS35VT-1000**  
Stroke length(mm): 1000  
Retracted Length(mm): 810



Matching Control Box: BBSB35Q



Optional Matching: BBSHR35F



## CONTROL SYSTEM

### START A HEALTHY OFFICES STATE, MAKE YOUR LIFE FULL OF POSSIBILITIES

Up & Down control / Sit & Stand reminder / Office data statistics used in mobile and computer



#### AIDESK Control System

- Control UP & DOWN by mobile phone
- Applicable for android and IOS system
- Sedentary reminder function



#### AIWORKING Desk Control Software

- Control by computer software
- Display the height
- Show the standing-time and calorie-buring results
- To memory the height of standing and sitting
- Statistical datas and health management

# BIBUS Teknoloji | Satış Ağımız

## Genel Merkez

Switzerland  
**BIBUS AG**  
Allmendstrasse 26  
8320 FEHRALTORF  
Tel. +41 44 877 50 11  
Fax +41 44 877 50 19  
E-Mail info.bag@bibus.ch  
www.bibus.ch

Switzerland  
**BIBUS HYDRAULIK AG**  
Allmendstrasse 26  
8320 FEHRALTORF  
Tel. +41 44 877 52 11  
Fax +41 44 877 52 19  
E-Mail bibushydraulik@bibus.ch  
www.bibushydraulik.ch

## Dünya'da BIBUS

Austria  
**BIBUS Austria Ges.m.b.H.**  
Eduard Klinger-Straße 12  
A-3423 St. Andri-Wördern  
Tel. +43 2242 333 88  
Fax +43 2242 333 88 10  
E-mail info@bibus.at  
www.bibus.at

Denmark  
**BIBUS Sindby A/S**  
Edisonvej 11  
7100 Vejle  
Tel. +45 75 88 21 22  
Fax +45 75 88 21 21  
E-mail bibus@bibus.dk  
www.bibus-sindby.dk

Bulgaria  
**BIBUS Bulgaria Ltd.**  
2 Blvd. Prof. Tzvetan Lazarov,  
Floor 2, 1574 SOFIA  
Tel. +359 2 971 98 08  
Fax +359 2 927 32 64  
E-mail info@bibus.bg  
www.bibus.bg

Germany  
**BIBUS GmbH**  
Max-Eyth-Straße 41/1  
89231 NEU-ULM  
Tel. +49 731 20 76 90  
Fax +49 731 20 76 96 20  
E-mail info@bibus.de  
www.bibus.de

Latvia  
**BIBUS Baltics SIA**  
Kleistu iela 24  
LV-1067 RIGA  
Tel. +371 6763 05 01  
Fax +371 6763 05 01  
E-mail info@bibusbaltics.eu  
www.bibusbaltics.eu

France  
**BIBUS France S.A.S.**  
ZA du Chapotin Sud  
233, rue des Frères Voisin  
69970 CHAPONNAY  
Tel. +33 4 78 96 80 00  
Fax +33 4 78 96 80 01  
E-mail contact@bibusfrance.fr  
www.bibusfrance.fr

Malaysia  
**BIBUS Malaysia Sdn. Bhd.**  
7, Jalan Kartunis, U1/47,  
Glenmarie Temasya Industrial Park  
40150, Shah Alam, Selangor  
Tel. +60 3 5569 70 77  
Fax +60 3 5569 70 66  
Email info@bibus.my  
www.bibus.my

Spain  
**BIBUS Spain, S.L.**  
Rua do Arroncal, Vial C - Nave 4A  
Parque Empresarial Porto do Molle  
36350 NIGRAN (Pontevedra)  
Tel. +34 986 24 72 86  
Fax +34 986 20 92 47  
E-mail info@bibus.es  
www.bibus.es

Belarus  
**BIBUS doo**  
8th Per. Ilyicha 13a, office 2.1  
246013 GOMEL  
Tel. +375 232 29 31 39  
Fax +375 232 29 72 05  
E-mail info@bibus.by  
www.bibus.by

India  
**BIBUS India Pvt Ltd.**  
Yellapura Village, Kasaba Hobli,  
Near KSSIDC Industrial Area,  
Doddaballapura Taluk No. 102/25,  
1st Floor, Bangalore - 561203.  
Tel. +91-953 802 78 82  
E-mail info@bibus.in  
www.bibus.in

Great Britain  
**BIBUS (UK) Ltd**  
Unit 20-21 Soho Mills  
WOOBURN GREEN  
Bucks HP10 0PF  
Tel. +44 1628 533 300  
Fax +44 1628 533 377  
Email info@bibus.uk  
www.bibus.uk

Thailand  
**BIBUS Thailand**  
181/68 Soi Nuanchan 32  
Nuanchan Buengkhum District  
Bangkok 10230  
Tel. +66 90 894 98 67  
Fax +66 2 054 65 76  
Email info@bibus.co.th  
www.bibus.co.th

Bosnia  
**BIBUS doo**  
Karadordeva bb BA 76311  
Dvorovi-Bijeljina Hercegovina  
Tel. +387 55 423 444  
Fax +387 55 423 444  
E-mail info@bibus.ba  
www.bibus.ba

Germany  
**SAUER BIBUS GmbH**  
Lise-Meitner-Ring 13  
89231 NEU-ULM  
Tel. +49 731 1896 0  
Fax +49 731 1896 199  
E-mail info@sauerbibus.de  
www.sauerbibus.de

Poland  
**BIBUS Menos Sp. z o.o.**  
ul. Spadochroniarzy 18  
80-298 Gdańsk  
Tel. +48 58 660 95 70  
Fax +48 58 661 71 32  
E-mail info@bibusmenos.pl  
www.bibusmenos.pl

Switzerland  
**BIBUS Hydraulik AG**  
Allmendstrasse 26  
8320 FEHRALTORF  
Tel. +41 44 877 52 11  
Fax +41 44 877 52 19  
E-Mail bibushydraulik@bibus.ch  
www.bibushydraulik.ch

Slovenia  
**INOTEH d.o.o.**  
K železnici 7  
SI-2345 Bistrica ob Dravi  
Tel. +386 2 665 11 31  
Fax +386 2 665 20 81  
E-mail info@inoteh.si  
www.inoteh.si

Germany  
**WESER-PUMPEN GmbH**  
Güterstrasse 10  
27777 Ganderkesee  
Tel. +49 4222 947 510 0  
Fax +49 4222 947 510 10  
E-mail info@weser-pumpen.de  
www.weser-pumpen.de

Portugal  
**BIBUS Portugal, Lda**  
Centro Empresarial AAA  
Rua Ponte da Pedra, 240 - C4  
4470-108 Gueifães-Maia  
Tel. +351 22 906 50 50  
Fax +351 22 906 50 41  
E-mail info@bibus.pt  
www.bibus.pt

Turkey  
**BIBUS Endüstriyel A.Ş.**  
İkitelli OSB Bedrettin Dalan Bulvarı  
Vip Plaza Kat:2 No:43-44, 34490  
Başakşehir / İSTANBUL  
Tel. 444 20 38  
Fax +90 212 249 88 34  
E-mail info@bibus.com.tr  
www.bibus.com.tr

China  
**BIBUS Shanghai Mec. Ltd.**  
2nd Floor, Block 9, No. 188  
Shanfeng Road 201508  
Tel. +86 21 5803 9270  
Fax +86 21 6729 8667  
E-mail info@bibuschina.cn  
www.bibuschina.cn

Netherlands  
**BIBUS Romicon B.V.**  
Vlijtweg 10A  
8191 JP Wapenveld  
Tel. +31 38 447 91 81  
E-mail info@bibusromicon.nl  
www.bibusromicon.nl

Romania  
**BIBUS Ses Srl**  
134/1 Calea Lugojului  
307200 GHIRODA, TIMIS  
Tel. +40 256 200 500  
Fax +40 356 446 660  
E-mail office@bibus.ro  
www.bibus.ro

Turkey  
**BIBUS Hidrotos A.Ş.**  
Ostim OSB 1233. Cd. No:149  
Yenimahalle/Ankara  
Tel. +90 312 354 29 27  
Fax +90 312 354 91 61  
E-mail info@bibushidrotos.com.tr  
www.bibushidrotos.com.tr

Croatia  
**BIBUS Zagreb d.o.o.**  
Anina 91  
HR-10000 ZAGREB  
Tel. +385 1 3818 004  
Fax +385 1 3818 005  
E-mail bibus@bibus.hr  
www.bibus.hr

Hungary  
**BIBUS Kft.**  
Almáskert út 9.  
2220 VECSÉS  
Tel. +36 29 557 764  
Fax +36 29 557 777  
E-mail info@bibus.hu  
www.bibus.hu

Russia  
**BIBUS o.o.o.**  
Zemskaya street 94  
198205 ST. PETERSBURG  
Tel. +7 800 100 14 52  
Fax +7 812 309 41 51  
E-mail info@bibus.ru  
www.bibus.ru

Ukraine  
**BIBUS Ukraine TOY**  
Soborna st., 118 the village of  
Sofiyivska Borschagivka  
Kiev region 08147  
Tel. +380 44 545 44 04  
Fax +380 44 545 54 83  
E-mail info@bibus.ua  
www.bibus.ua

Czech Republic  
**BIBUS s.r.o.**  
Videňská 125  
619 00 BRNO  
Tel. +420 547 125 300  
Fax +420 547 125 310  
E-mail bibus@bibus.cz  
www.bibus.cz

Italy  
**BIBUS Italia Srl**  
Via Robert Fulton, 27  
San Giovanni in Persiceto (BO)  
40017 C.F. e P.IVA n. 03248661203  
Tel. +39 051 893958  
Fax +39 051 780081  
E-mail info@bibus.it  
www.bibus.it

Slovakia  
**BIBUS SK s.r.o.**  
Trnavska 31  
949 01 NITRA  
Tel. +421 37 777 79 11  
Fax +421 37 777 79 19  
E-mail sale@bibus.sk  
www.bibus.sk

Vietnam  
**BIBUS Vietnam Technology Co., Ltd.**  
No. 10, Lot K, Hoang Quoc Viet street  
Phu My Ward, District 7, Ho Chi Minh City,  
Tel. +84 28 3785 0627  
Fax +84 8 378 506 28  
E-mail info@bibus.vn  
www.bibus.vn