

Tube Connectors



Assembly Tools and Devices



Germany

Walter Stauffenberg GmbH & Co. KG

Im Ehrenfeld 4
58791 Werdohl
Tel.: +49 2392 91 60
Fax: +49 2392 91 61 03
E-Mail: sales@stauff.com
www.stauff.com

STAUFF products and services are globally available through wholly-owned subsidiaries and a tight network of authorised distributors and representatives in all major industrial regions of the world.

You can find detailed contact information on the last two pages of this product catalogue or at www.stauff.com.

Please note: Unless otherwise stated, all data and figures in this product catalogue are approximate values and are only valid as references, which are not binding (also in respect to any third parties' rights of protection) and thus do not release the customer / user from checking and testing the suitability of the products for the foreseen purposes. Therefore, data and figures can only be used in a limited sense for construction purposes.

The application of the products is beyond the control possibilities of the manufacturer and, therefore, is exclusively subject to the responsibility of the customer / user.

In the event that a liability is nevertheless considered, any compensation will be limited to the value of the goods supplied by the manufacturer and used by the customer / user. As a matter of course, the manufacturer guarantees the perfect quality of all products in accordance with the General Terms and Conditions of Business and Sale.

Subject to modifications due to the ongoing development and improvement of the products.

With the publication of this product catalogue, previous editions are no longer valid.

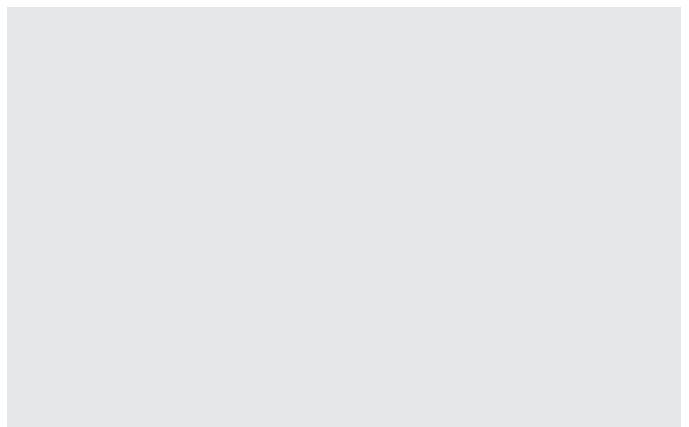
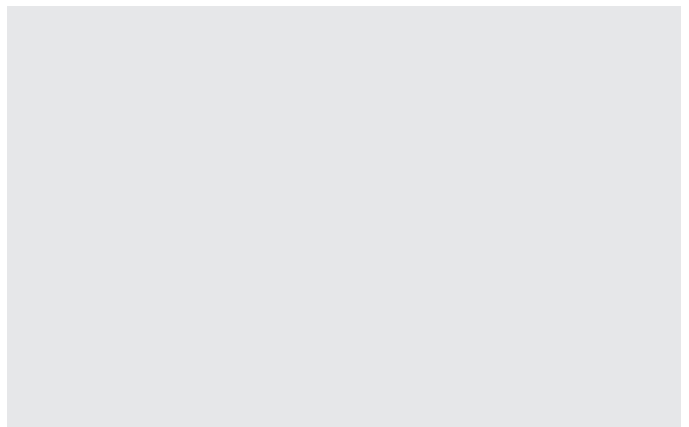

Introduction	4 - 11	
System Overview	12 - 23	A
Connecting Parts	24 - 35	B
Male Stud Fittings	36 - 79	C
Tube Fittings / Unions	80 - 89	D
Bulkhead Fittings	90 - 95	E
Weld Fittings	96 - 105	F
Female Stud / Gauge Fittings	106 - 113	G
Fittings with 24° Taper / O-Ring (DKO)	114 - 129	H
Standpipe Fittings	130 - 145	I
Fittings with Lock Nut	146 - 155	J
Banjo Fittings	156 - 169	K
Swivel Fittings	170 - 173	L
Hydraulic Valves	174 - 185	M
Custom-Designed Solutions	186 - 189	N
Spare Parts / Accessories	190 - 215	O
Assembly Tools / Devices	216 - 243	P
Assembly Instructions	244 - 277	Q
Technical Appendix	278 - 297	R
Appendix (Product-Specific Abbreviations / Global Contact Directory)	298 - 303	





Catalogue 1 STAUFF Clamps

- Block Clamps
- Special Clamps
- Light Series Clamps
- Saddle Clamps
- U-Bolt Clamps
- Metal Clamps
- Construction Series

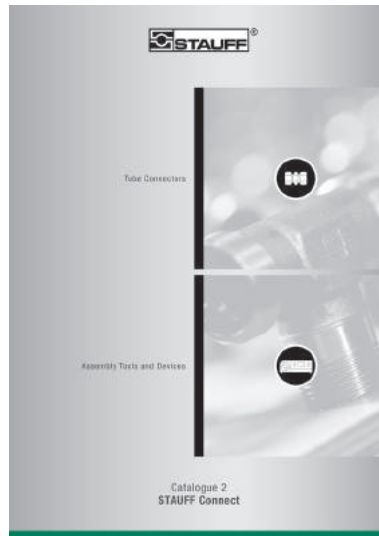

Catalogue 2 STAUFF Connect

- Tube Connectors
- Assembly Tools and Devices

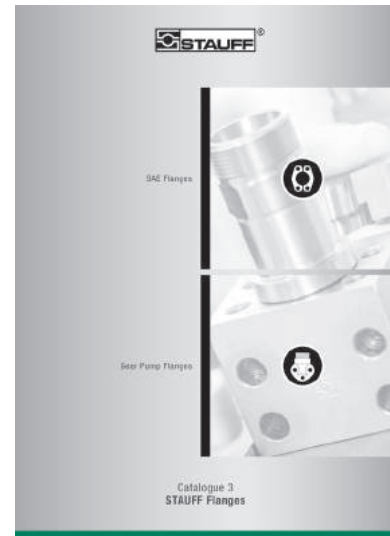

Catalogue 3 STAUFF Flanges

- SAE Flanges
- Gear Pump Flanges



Catalogue 4 STAUFF Hose Connectors

- Hose Connectors
- High-Pressure Hose Connectors

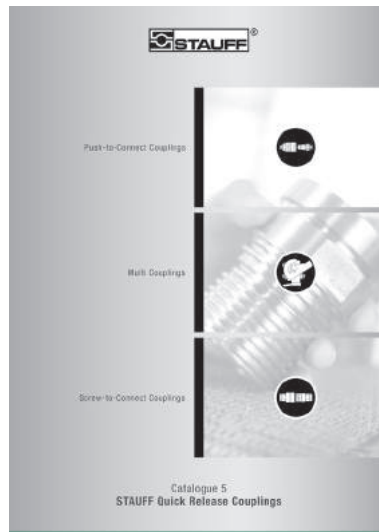

Catalogue 5 STAUFF Quick Release Couplings

- Push-to-Connect Couplings
- Multi Couplings
- Screw-to-Connect Couplings



Catalogue 6 STAUFF Valves

- Two-Way Ball Valves
- Multi-Way Ball Valves
- Flow Control and Check Valves
- Gauge Isolator Valves





Catalogue 7 STAUFF Test

- Test Couplings
- Test Adaptors
- Test Hoses and Connectors



Catalogue 8 STAUFF Diagtronics

- Pressure Gauges
- Hydraulic Testers
- Oil Analysis Equipment



Catalogue 9 STAUFF Filtration Technology

- Replacement Filter Elements
- Pressure Filters
- Return-Line Filters
- In-Line Filters
- Spin-On Filters
- Offline and Bypass Filters
- Filtration Systems

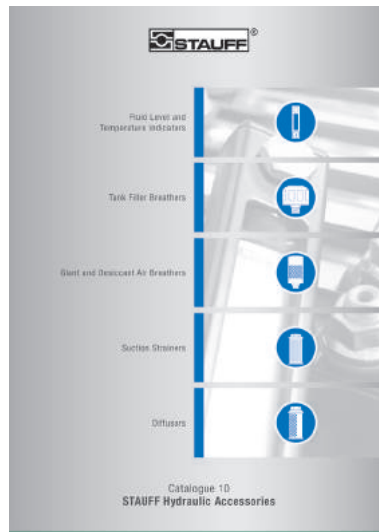

Catalogue 10 STAUFF Hydraulic Accessories

- Fluid Level and Temperature Indicators
- Tank Filler Breathers
- Giant and Desiccant Air Breathers
- Suction Strainers
- Diffusers



For more than 50 years, the companies of STAUFF Group have been developing, manufacturing and distributing pipework equipment and hydraulic components for mechanical and plant engineering and for service and industrial maintenance.

In addition to mobile and industrial hydraulic machinery, typical applications also include commercial and special purpose vehicles, rail transportation and energy technology. Likewise, STAUFF products are used in marine, oil and gas applications and in the process, food and chemical industries.

The overall range currently includes about 40000 standard products as well as numerous special and system solutions according to customer's specifications or based on our in-house development.

All STAUFF products undergo relevant testing in accordance with international regulations and are governed by the high standards of the in-house quality management system. Furthermore, many items have received certifications and approvals from various international institutes, organisations and authorities who have independently confirmed the quality and performance of the products.

Wholly-owned manufacturing, sales and service facilities in 18 countries and a tight global network of authorised distribution partners ensure high presence and service paired with a maximum of availability.



Quality Management – ISO 9001:2015
Environmental Management – ISO 14001:2015
Safety Management OHSAS – 18001:2007

STAUFF LINE Components

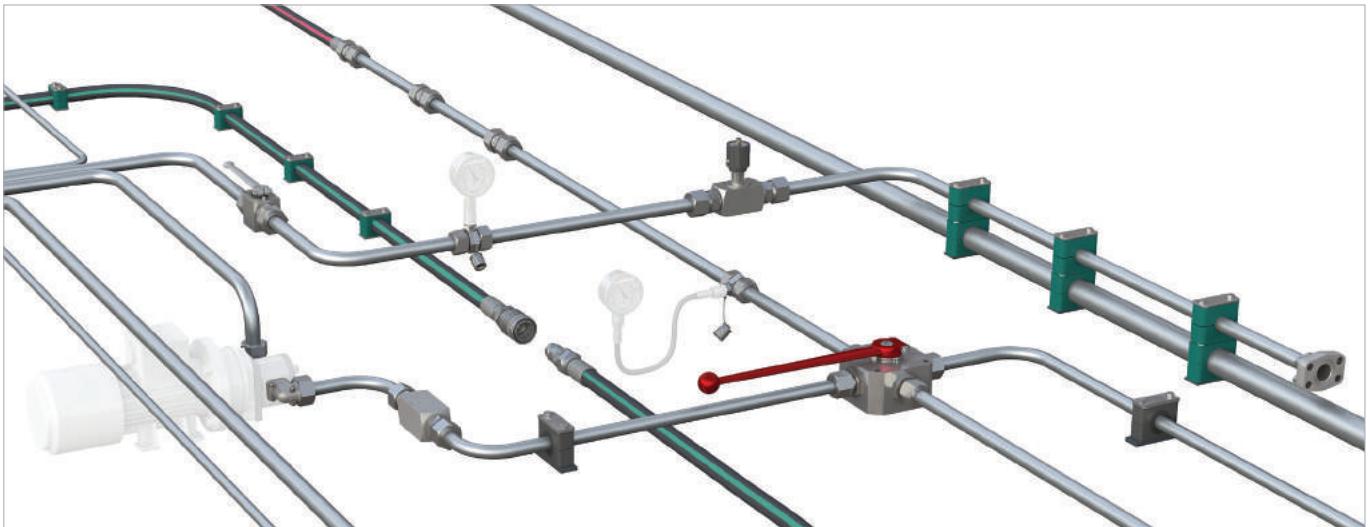

With the seven dedicated **STAUFF Line** product groups

- **STAUFF Clamps**
- **STAUFF Connect**
- **STAUFF Flanges**
- **STAUFF Hose Connectors**
- **STAUFF Quick Release Couplings**
- **STAUFF Valves**
- **STAUFF Test**

from own, in-house development and manufacturing, the companies of the STAUFF Group provide a comprehensive range of components for fastening and connecting pipes, tubes and hoses for mobile and industrial hydraulic applications and many other industries.

The portfolio is completed by components for shutting-off, regulating, throttling and measuring fluid media.

In order to perfectly match each other, STAUFF Line products are designed and offered on a high, uniform level of quality. A large proportion of the range made from steel comes as standard with the premium STAUFF Zinc/Nickel surface coating, which is also optionally available for many of the other components.

This coating offers the most reliable surface protection far beyond the previous market standards – even after transport, handling and assembly of the components – and meets all current legal requirements.

If desired, Original Equipment Manufacturers can be supported with value-added services, from **technical consultation to pre-assembly, assembly and kitting** as well as **logistics services**:

- Support with the **selection of suitable standard components** and ordering options; provision of **customised solutions** according to customer's specifications or based on our in-house development – from prototyping to large scale production
- **Analysis and optimization** of existing and design and developments of new systems aimed at increasing the efficiency and performance of machines and equipment and creating value for customers by reducing the total cost
- **Pre-assembly, assembly and kitting** of individual components to customer-specific system modules
- Individually coordinated **procurement solutions** (e.g. web shop and electronic data interchange) and **supply models** (e.g. from warehousing of customised components to Kanban logistics and just-in-time delivery of pre-fabricated system modules to the assembly lines of the customers) aimed at optimising material flows



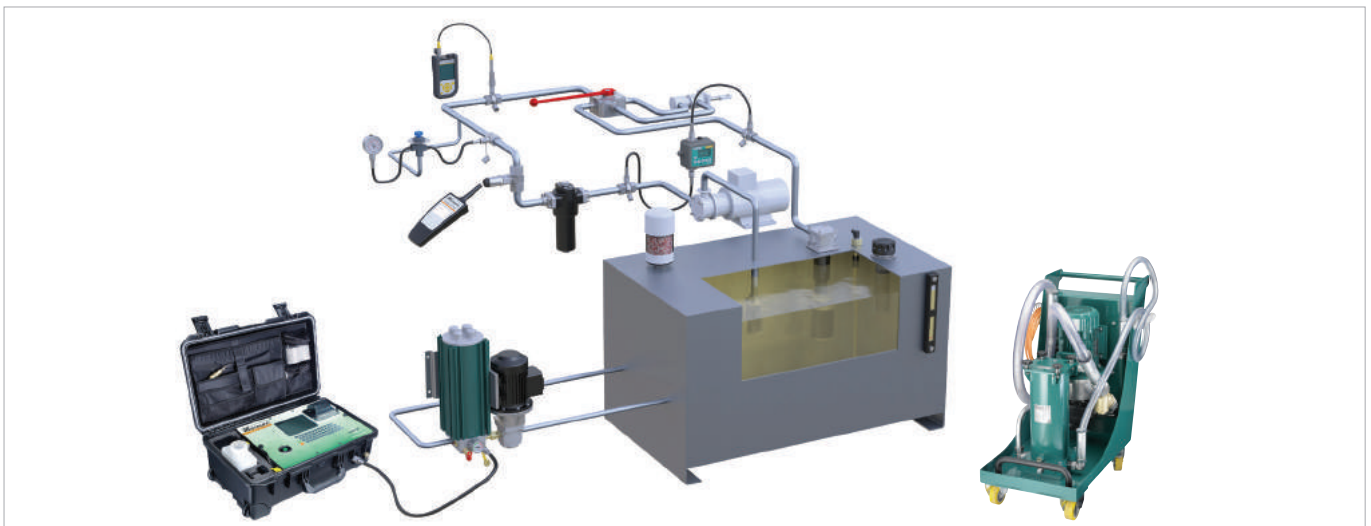

Aligned with the needs of the market, the product groups

- **STAUFF Test**
- **STAUFF Diagtronics**
- **STAUFF Filtration Technology**
- **STAUFF Hydraulic Accessories**

include a comprehensive range of analogue and digital measuring equipment and devices, filtration systems and replacement filter elements as well as accessories for the construction of tanks, reservoirs, power packs and gear boxes in mobile and industrial hydraulics.

The offer is completed by relevant value-added services:

- Support with the **selection of suitable components** and ordering options; provision of **customised solutions** according to customer's specifications or based on our in-house development – from prototyping to large scale production
- Analysis of existing hydraulic circuits aimed at filtration systems, tank components and monitoring devices that perfectly match to the specific requirements, and developing integrated concepts to increase the efficiency and performance of machines and equipment
- Individually coordinated **procurement solutions** and **supply models**



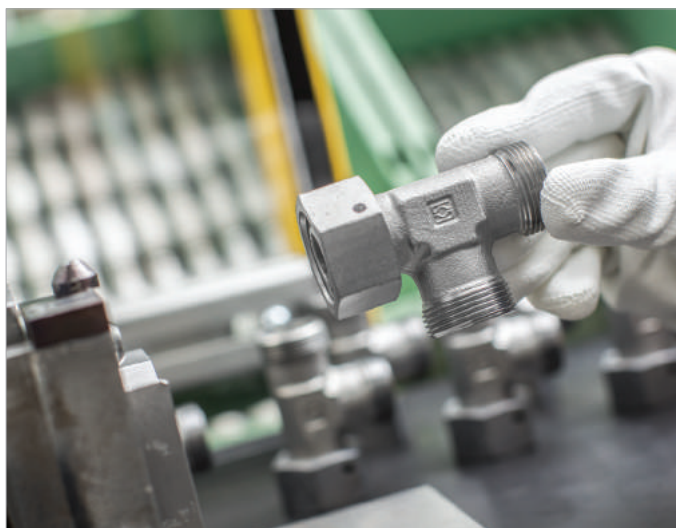

STAUFF Connect

The STAUFF Connect product group is closely aligned with the market requirements and contains an extensive range of tube connectors made of carbon steel for metric tubes with outer diameters ranging from 4 to 42 mm in accordance with ISO 8434-1 / DIN 2353:

- 24° cutting ring fittings
- 24° taper fittings with O-ring
- 24° weld cones with O-ring
- 37° flared tube fittings

The product range is completed by check and alternating valves for inline installation, thread reducers as well as blanking plugs and screws.

Special product types and sizes as well as alternative materials, material combinations and surface coatings deviating from the standards can be supplied on request.

Automated assembly machinery and hardened, wear-resistant tools enable the reliable assembly of tube connectors – both for series production in the workshop and on-site.

Because of its versatility and flexibility, the patented STAUFF Form tube forming system is undoubtedly the best solution for series production, in particular for applications with highest requirements with regards to safety, reliability and repeatability as well as process stability.

For the finishing of the tube connector range in carbon steel, STAUFF relies on the STAUFF Zinc/Nickel surface coating which has proven successful for many years. It provides reliable surface protection – even after transport, handling and assembly – and meets all current legal requirements.

For selected types and series, independent certificates and approvals can be provided:

- Bureau Veritas
- DNV GL
- Lloyd's Register
- Russian Maritimes Register of Shipping



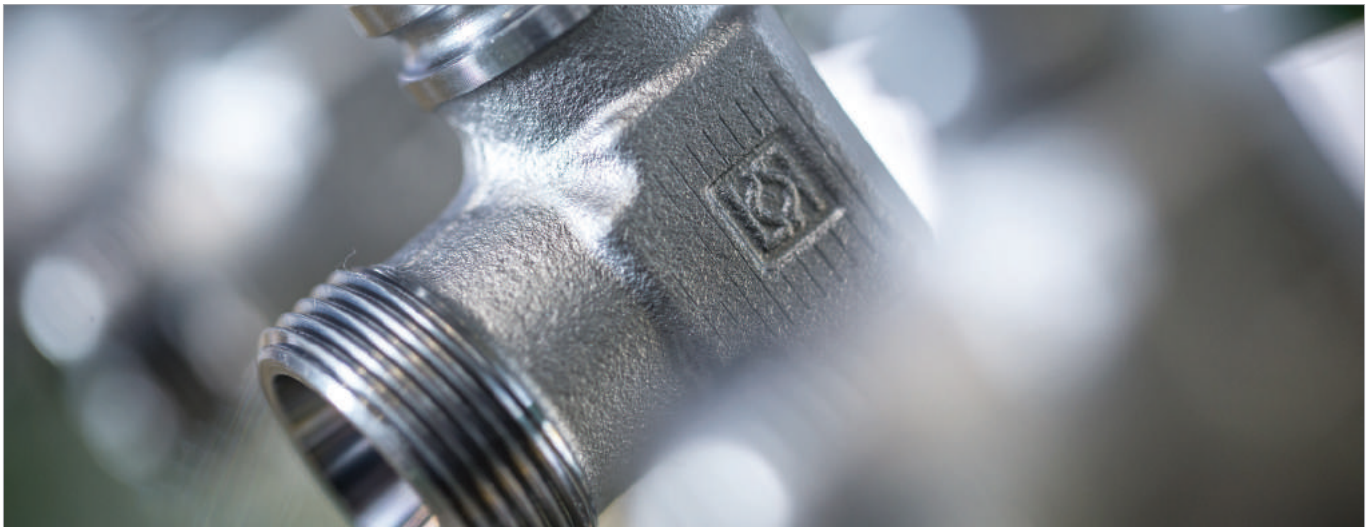

STAUFF Zinc/Nickel Coating



Layers

- Sealing
- Passivation
- Zinc/Nickel
- Steel

With at least 1200 hours resistance against red rust, the STAUFF Zinc/Nickel surface coating offers excellent surface protection – even after transport, handling and assembly. This was confirmed by testing in the salt-spray chamber according to DIN EN ISO 9227.

Users across all industries and applications benefit from sophisticated technology, which has been developed for and used by the very demanding automotive industry for many years now and that is already the proven standard for a large proportion of STAUFF components since 2007.

- At least 1200 hours resistance to red rust / base metal corrosion under practical conditions in the salt-spray chamber according to DIN EN ISO 9227
- White rust occurs only by way of a slight grey haze
- Surpassing the requirements of the corrosion protection class K5 as defined by the VDMA, the German Engineering Association (360 hours resistance to white rust / 720 hours resistance to red rust)
- Free of hexavalent chrome Cr(VI)
- ELV compliant according to 2000/53/EC (End of Life Vehicles Directive)
- REACH compliant according to 1907/2006/EC (Registration, Evaluation, Authorisation and Restriction of Chemicals)
- RoHS compliant according to 2002/95/EC (Restrictions of the Use of Hazardous Substances)
- Appealing colour scheme with a bright semi-gloss surface finish – comparable to Stainless Steel
- Significantly reduced tendency to corrosion by contact with other metals (such as Aluminium and Stainless Steel)
- Improved abrasion resistance due to the ductility / plastic deformability of the coating
- Little to no risk of triggering allergies – nickel release is down to only a fraction of the statutory limits relating to objects which come into direct and prolonged contact with the skin (independent results of the reference test method according to DIN EN 1811 are available on request)
- Good paint adhesion properties
- Resistance against all commonly used hydraulic media





www.stauff.com/catalogues

The STAUFF online catalogue centre at www.stauff.com/catalogues provides fast and direct access to digital versions of this as well as other STAUFF product catalogues in all available languages.

Online Page-Flip Catalogues

- Easy navigation through index or the powerful full text search functionality
- Contents can be shared and forwarded by e-mail, printed or downloaded and saved in PDF file format
- Also suitable for mobile devices

Download Catalogues

- Download entire product catalogues and save them in PDF file format

Catalogue Request

- Contact form to request printed copies of the product catalogue as well as digital copies on CD-ROM or USB stick

The fastest way to the online page-flip catalogue:

The links that can be found at the bottom edge of all pages of this product catalogue will lead you directly to the corresponding page in the online page-flip catalogue.

In doing so, contents can be searched, shared and forwarded by e-mail, printed or downloaded and saved in PDF file format.

Scan the QR code next to the direct link with the camera of your mobile device* and also use the functions in this way.

* may require a suitable app



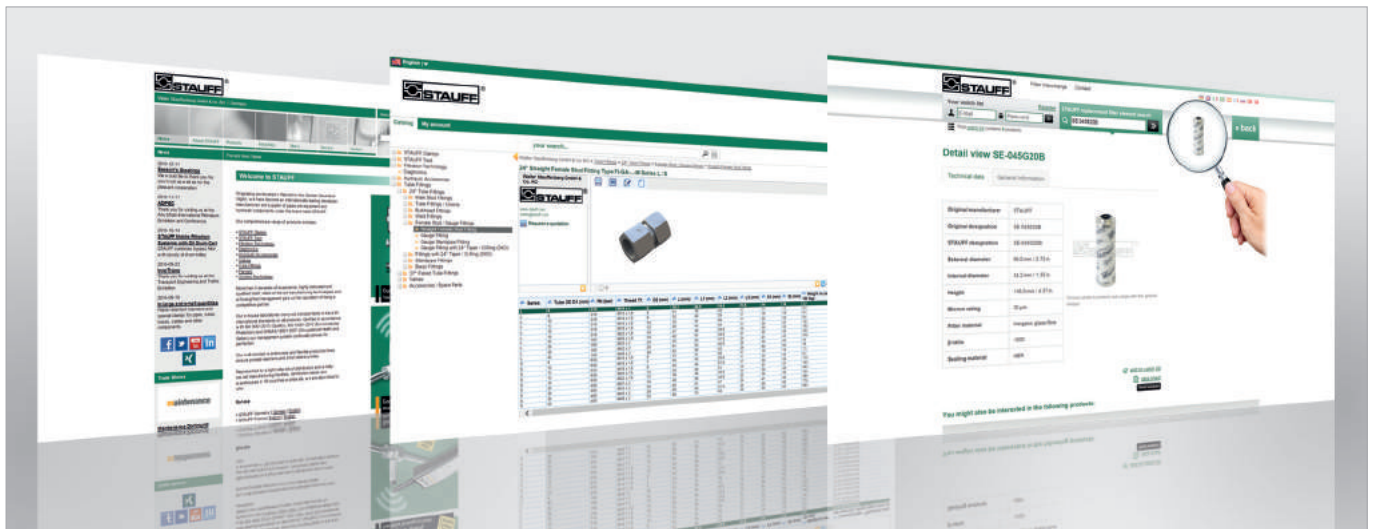

www.stauff.com

General information about the companies of STAUFF Group, latest business and product news as well as complete global contact details

www.stauff.com/cad

Immediate access to and free download of 3D models and 2D drawings for a growing number of STAUFF products

www.filterinterchange.com

Online database for the quick and easy identification and interchange of almost all common brands and types of replacement filter elements

Follow STAUFF and keep yourself updated:

- 
Facebook
www.facebook.com/stauffgroup
- 
Twitter
www.twitter.com/stauffgroup
- 
LinkedIn
www.linkedin.com/company/stauff
- 
Youtube
www.youtube.com/stauffgroup





24° Tube Fittings in General	14
24° Tube Fittings with Single / Double Edge Cutting Ring	16
24° Tube Fittings with Soft-Sealing Cutting Ring	17
Tube Fittings with 24° Taper / O-Ring (DK0)	18
24° Weld Cones with O-Ring	19
24° Tube Fittings using the STAUFF Form Tube Forming System	20
37° Flared Tube Fittings	22



24° Tube Fittings in General

A

24° Conical Bore of the Fitting Body
(Shape W according to DIN 3861)

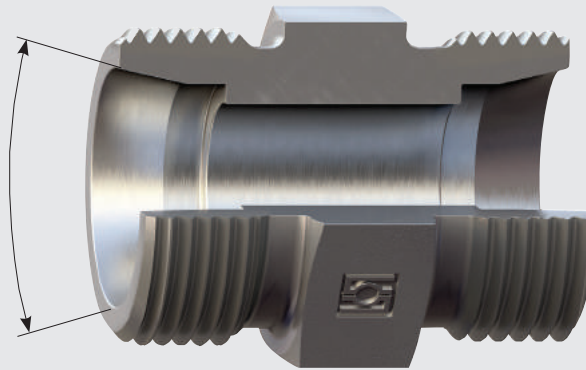

24° Tube Fittings are surely among the most commonly used and established industrial tube connector systems worldwide. They are regarded as the universal standard for fluid power applications in markets that use the metric system, such as Europe, Asia, Africa and South America.

Even in regions that traditionally used or still use the imperial measurement system (such as Australia or Northern America) 24° tube fittings are gaining more and more acceptance due to the ongoing metrification and specifications by globally operating OEMs.

24° Tube Fittings are specified in the ISO 8434-1 and DIN 2353 standards.

At least one tube connection end of the fitting body is characterized by a 24° conical bore (shape W according to DIN 3861), which serves as a metallic sealing surface, while the other end of the body is available with a variety of different connection types, such as male and female threaded or weld studs.

Various shapes (e.g. straight fittings, elbows, tees, crosses etc.) and designs (e.g. unions, studs, bulkheads or adjustable fittings) are available.

The portfolio consists of the Extra-Light (LL) Series as defined in the DIN 2353 standard as well as the Light Series (L) and the Heavy Series (S) as defined in the ISO 8434-1 standard, which differ from each other in particular with regards to their dimensions and pressure ratings.

Main Advantages of the 24° Tube Fitting System

- 24° Tube Fittings can be quickly and easily field-assembled and even re-assembled with just a couple of standard wrenches and no requirement for hours of expensive staff training or special tube treatment. Under regular conditions, subsequent re-tightening of 24° Tube Fittings is not necessary.
- Most types of 24° Tube Fittings are available and suitable for light, medium, heavy and extra-heavy wall tubing with outside diameters ranging from 4 to 42 mm / .16 to 1.65 in, which allows optimum dimensioning of pipework circuits and saves material cost.
- The 24° Tube Fitting System is available in the Extra-Light (LL), the Light (L) and the Heavy (S) Series and provides suitable components with regards to sufficient pressure ratings and maximum leak-tightness up to nominal pressures of 800 bar / 11600 PSI (depending on series, type and size of the component – pressure reduction factors to be considered) for literally each application.
- Thanks to their optimised inner contour and design, 24° Tube Fittings offer ideal flow rates and therefore guarantee best performance without the excessive generation of vibrations, noise or heat.
- 24° Tube Fittings are small and compact in design compared to other systems, which makes them perfect for applications with space considerations.
- The recommended material raise in front of the first edge of the cutting ring after the assembly is clearly visible to tube fitters and inspectors and makes it easy to check and confirm the correct assembly of 24° Tube Fittings.
- On-site piping with 24° Tube Fittings is very efficient and offers maximum flexibility for tube fitters as the exact required tube length can be easily checked in advance by just trying out.
- 24° Tube Fittings are easy to combine with other tube fitting systems – even hoses can be connected without difficulties.



Overview of 24° Tube Fittings

A

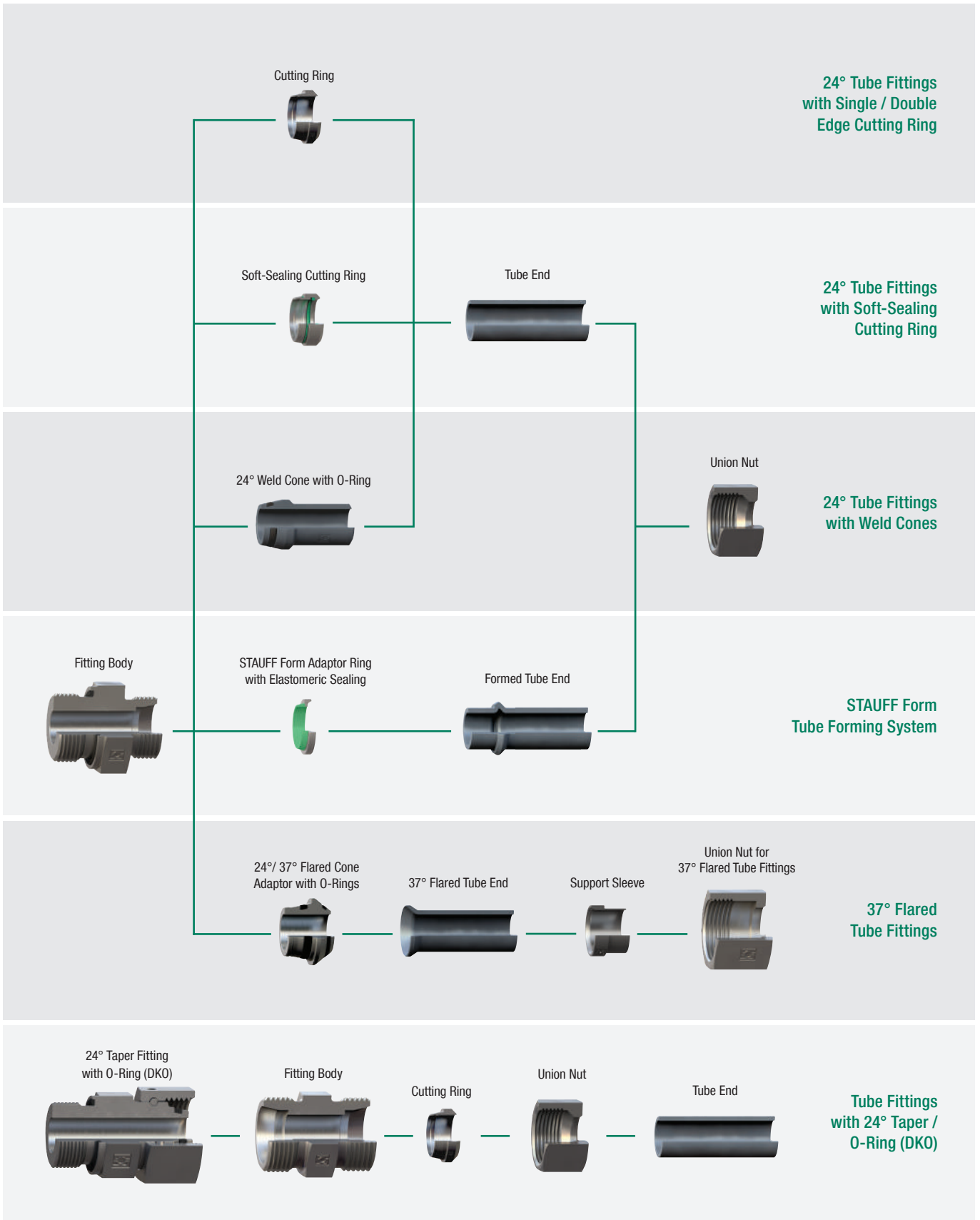

24° Tube Fittings with Single / Double Edge Cutting Ring

A

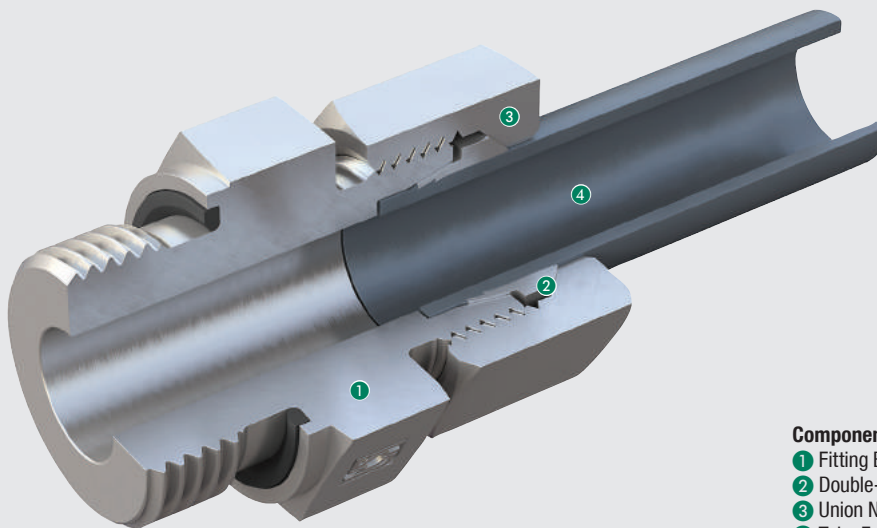

Components

- 1 Fitting Body – ISO 8434-1 / DIN 2353
- 2 Double-Edge Cutting Ring
- 3 Union Nut – ISO 8434-1 / DIN 3870
- 4 Tube End

STAUFF Connect 24° Tube Fittings with Cutting Ring have been developed and designed for the reliable, leak-free connection of metric tubes with outside diameters between 4 mm and 42 mm / between .16 in and 1.65 in respectively.

Therefore, the most relevant key dimensions of the tube fittings (e.g. through bores and widths across flats) also have metric dimensions.

With regards to their dimensioning and general design, STAUFF Connect 24° Tube Fittings with Cutting Ring fully comply with the latest versions of the ISO 8434-1 and the DIN 2353 standards.

The operating principle of STAUFF Connect 24° Tube Fittings with Cutting Ring is based on a double-edge cutting ring, which cuts into the tube twice, thus ensuring the necessary force and form closure in the cutting area.

Thanks to the optimised geometry of this ring, the two edges do not cut simultaneously, but rather one after the other. In addition to increasing the incising effect, this method maximises the tear strength of the fitting.

Due to the design of the double-edge cutting ring in the central region as well as in the shoulder area, a larger tube support surface with a high surface pressure is achieved without jamming the cutting ring. This ensures uniform distribution of force. The outer support surfaces of the cutting ring are smoothed, thus minimising friction losses during assembly and guaranteeing the maximum degree of safety during use.

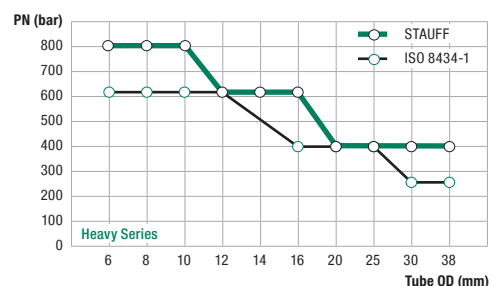
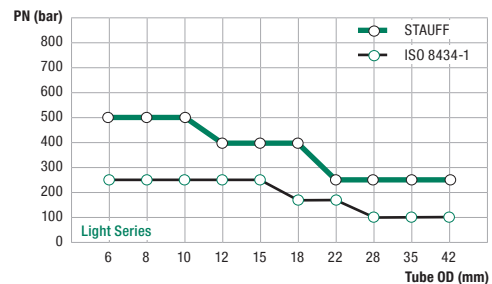

Nominal pressure levels of tube fittings



STAUFF Connect 24° Tube Fittings with Cutting Ring even exceed the ISO requirements in pressure: They can be used in applications with nominal pressures up to 500 bar / 7250 PSI in the Light Series and up to 800 bar / 11600 PSI in the Heavy Series (depending on series, type and size of the components – pressure reduction factors to be considered).

For dimensional reasons, STAUFF Connect 24° Tube Fittings with Cutting Ring in the Extra-Light Series use single-edge cutting rings (suitable for nominal pressures up to 100 bar / 1450 PSI)



24° Tube Fittings with Soft-Sealing Cutting Ring

A

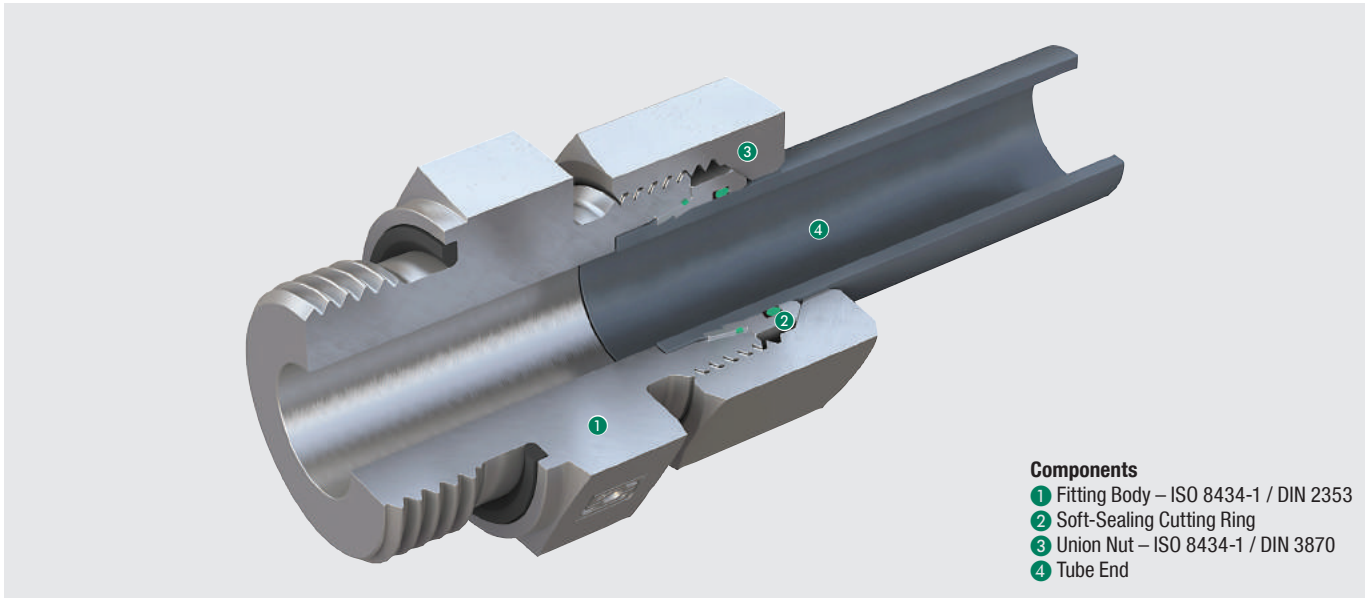

- Components**
- ① Fitting Body – ISO 8434-1 / DIN 2353
 - ② Soft-Sealing Cutting Ring
 - ③ Union Nut – ISO 8434-1 / DIN 3870
 - ④ Tube End

Soft-Sealing Cutting Rings provide an additional safety and protection against potential leakage risks, e.g. caused by the settling of purely metallic sealed connections, temperature fluctuations or considerable pressure and vibration loads in the system. "Sweating effects" on the connection points can be permanently avoided.

The type FI-WDDS Soft-Sealing Cutting Ring of the STAUFF Connect range is characterised by the elastomer sealing, which is located in a specially designed groove close to the rear end of the 24° taper and protected to prevent loss. An additional o-ring is used to secure the second potential leakage path between the cutting ring and the tube – even in the event of unfavourable tolerances

FKM (Viton®) is used as the standard sealing material and enables problem-free use of the system for challenging applications involving high temperatures or aggressive media.

Like all other components in the STAUFF Connect product range, the cutting ring itself is designed as standard with a high-quality zinc/nickel surface coating. With over 1,200 hours of resistance to red rust / base metal corrosion in the salt-spray chamber in accordance with DIN EN ISO 9227, the coating offers most reliable corrosion protection far beyond previously accepted market standards. Even after shipping, handling and assembly of the components, the coating significantly exceeds the requirements for the highest corrosion protection class K5 defined in VDMA Standard Sheet 24576 for tube connectors.

Alternative materials and surface and surface finishings are available on request.

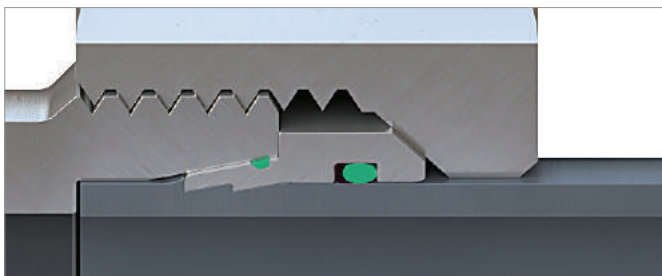

Both elastomer sealings are located in the secondary sealing zone of the connection. Static and dynamic loads in the system are primarily compensated by the tried and tested metallic sealed area. When assembled, the soft-sealing elements are almost completely chamfered (as gap-free and cavity-free as technically possible). This prevents extrusion of the sealings and contributes to the excellent longterm stability of the system.

Type FI-WDDS Soft-Sealing Cutting Rings convince through their simple assembly in the fitting body: Use a suitable spanner to tighten the union nut until the point where the cutting ring comes into contact and sits closely with the face side of the fitting body. This point is characterised by a significant increase in force.

Due to the design, the risks of insufficient assembly as well as over-assembly of cutting rings (which can lead to damage or radial constriction of thin-walled tubes) can be significantly reduced.

As a matter of course, the recommended material raise in front of the first edge of the cutting ring after the completed assembly is clearly visible to tube fitters and inspectors and makes it easy to check and confirm the correct assembly – as required by the norm.

Type FI-WDDS Soft-Sealing Cutting Ring are available for all metric tubes with outside diameters between 6 mm and 42 mm / between .24 in and 1.65 in respectively. They even exceed the ISO requirements in pressure and can be used in applications with nominal pressures up to 500 bar / 7250 PSI in the Light Series and up to 800 bar / 11600 PSI in the Heavy Series (depending on series, type and size of the components – pressure reduction factors to be considered).

Users benefit from the great versatility and flexibility of the system, as well as the many combination and adaptation options offered by using standard components from the STAUFF Connect product range (in accordance with the latest versions of the ISO 8434-1 and the DIN 2353 standards). There is therefore no need to duplicate the stock-keeping of similar components with a correspondingly high likelihood of confusion, as is often the case with comparable systems. Material and logistics costs can thus be correspondingly reduced.

Connections using regular, purely metallic sealing double-edge cutting rings can be interchanged without any problems.

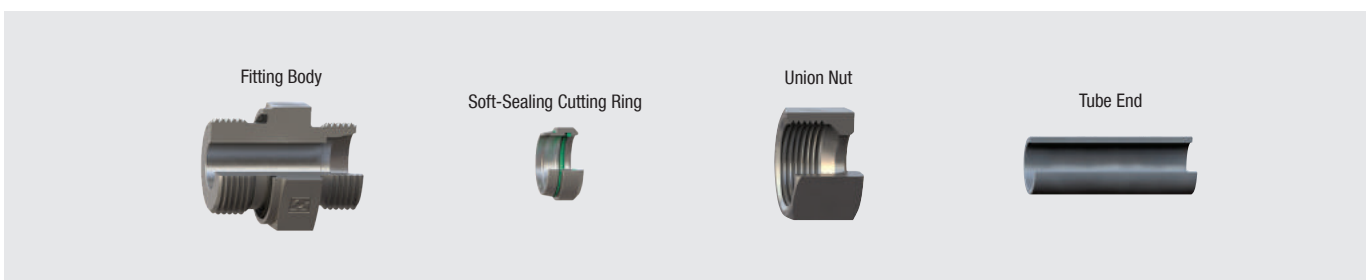

Tube Fittings with 24° Taper / O-Ring (DKO)

A

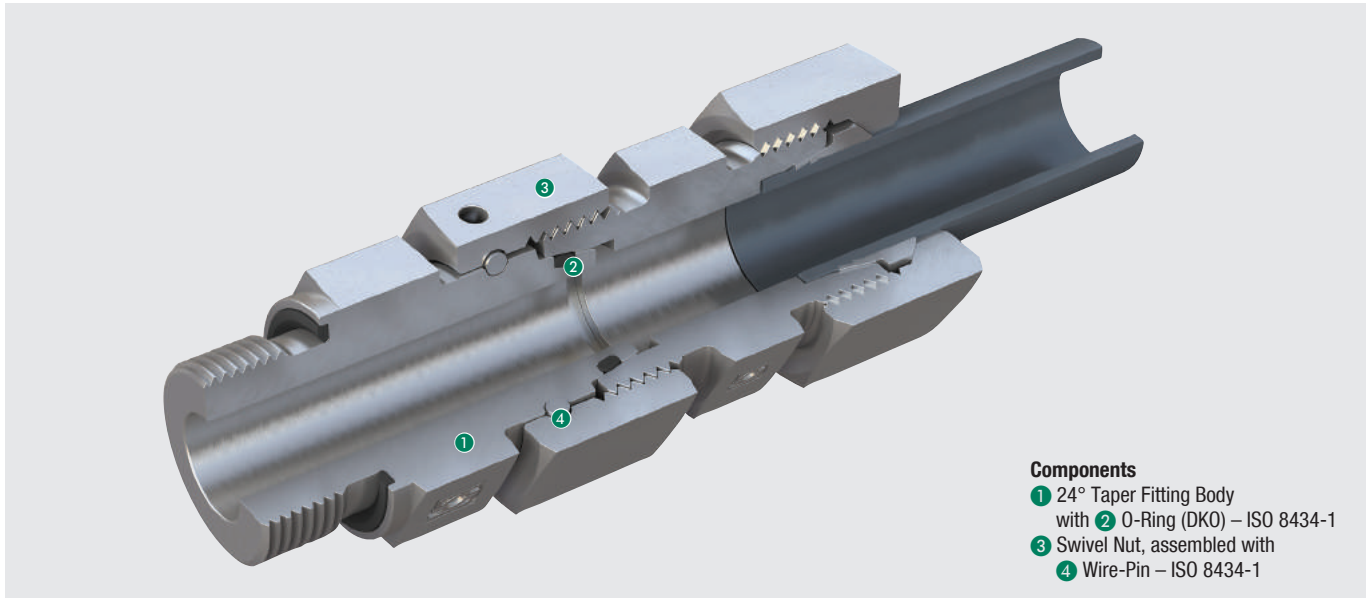

Components

- ① 24° Taper Fitting Body with ② O-Ring (DKO) – ISO 8434-1
- ③ Swivel Nut, assembled with ④ Wire-Pin – ISO 8434-1

Due to the 24° taper (with o-rings) located on the fitting body itself, STAUFF Connect Tube Fittings with 24° Taper / O-Ring (DKO) represent a logical further development of traditionally available adjustable standpipe tube fittings with factory-assembled cutting rings and union nuts.

The retention function is assured by a special swivel nut with a wire-pin located in a groove, which is factory-assembled by the manufacturer.

The embedded o-ring on the 24° taper ensures a high level of protection against leakage.

Thanks to the large number of available types and designs, almost all common types and combinations of adjustable fittings can be implemented.

With regards to their dimensioning and general design, STAUFF Connect Tube Fittings with 24° Taper / O-Ring (DKO) fully comply with the latest versions of the ISO 8434-1 standard. They are thus completely interchangeable with conventional adjustable standpipe tube fittings.

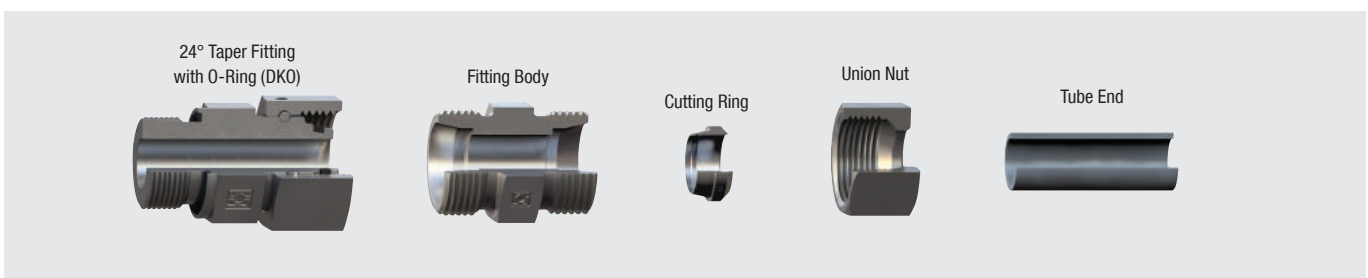

24° Weld Cones with O-Ring

A

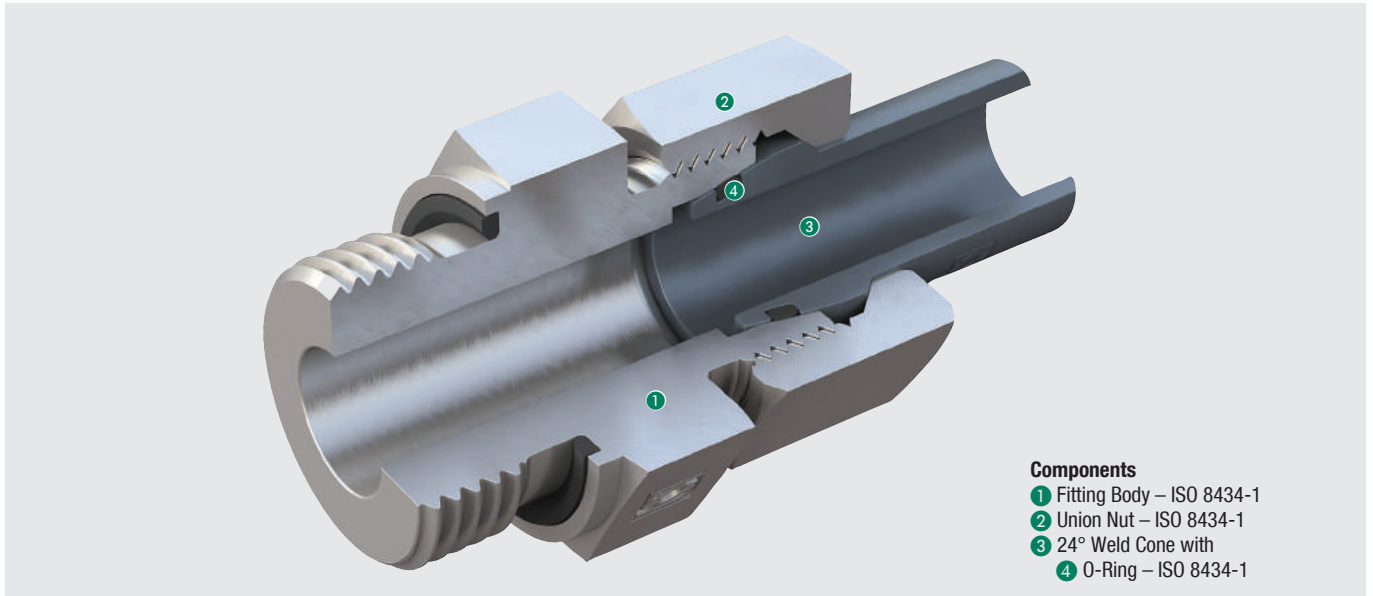

Components

- ① Fitting Body – ISO 8434-1
- ② Union Nut – ISO 8434-1
- ③ 24° Weld Cone with
- ④ O-Ring – ISO 8434-1

STAUFF Connect 24° Weld Cones with O-Ring represent a supplement to the usual range of tube fittings. However, they are increasingly perceived as a special solution due to the complex tube preparation, assembly, finishing and testing, as are all other types of welded connectors.

STAUFF Connect 24° Weld Cones with O-Ring are directly welded to the tube end.

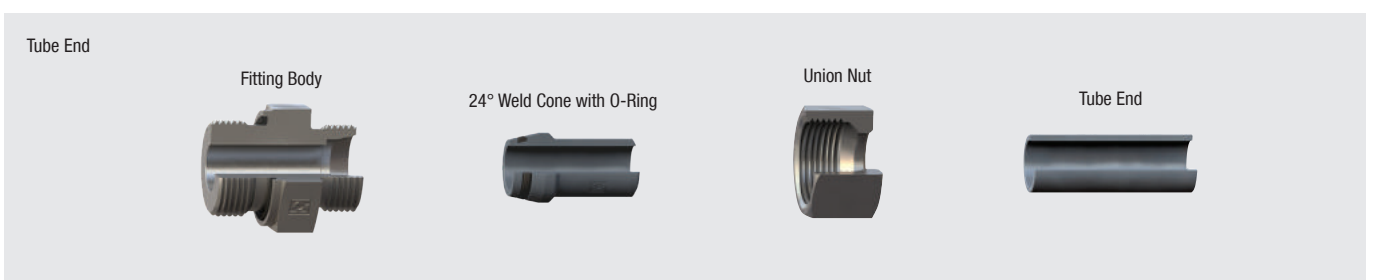
With regards to their dimensioning and general design, they fully comply with the latest versions of the ISO 8434-1 standard.



24° Tube Fittings using the STAUFF Form Tube Forming System

A

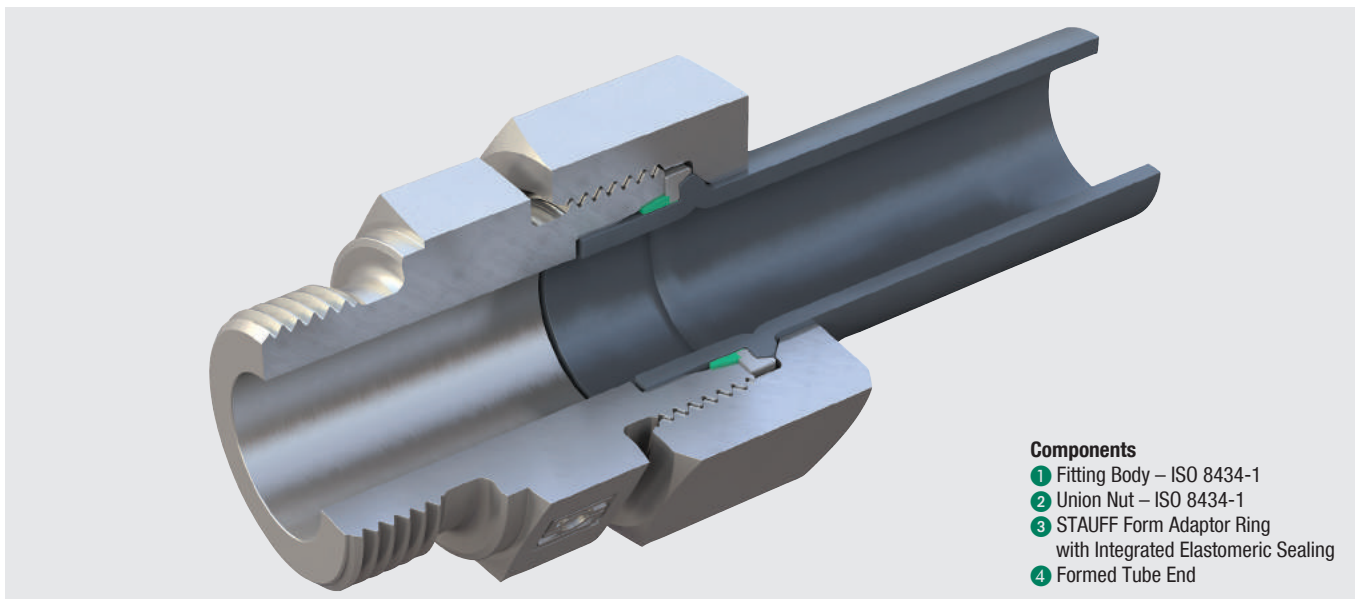

Components

- ① Fitting Body – ISO 8434-1
- ② Union Nut – ISO 8434-1
- ③ STAUFF Form Adaptor Ring with Integrated Elastomeric Sealing
- ④ Formed Tube End

Performance

The patented STAUFF Form tube forming system is without doubt one of the most high-performing solutions currently available on the market for connecting metric sized tubes. Apart from its simplicity, it also provides a maximum level of safety, reliability and reproducibility.

STAUFF Form has been designed as standard for seamless cold-drawn precision steel tubes as well as stainless steel tubes with dimensions between 6 x 1.5 mm and 42 x 4 mm in the Light Series and between 6 x 1.5 mm and 38 x 6 mm in the Heavy Series. Parameters for alternative materials (copper, brass, CuNiFe, Tungum etc.) can be added by the manufacturer, if required.

System Design and Components

The system is based on standard parts and consists of only four key components:

The STAUFF Form Ring with an integrated and thus undetachable elastomeric sealing is slid onto the tube end, which has previously been mechanically contoured. This creates a positive-locking connection that provides a reliable, permanent and maintenance-free seal when used with a conventional fitting body with 24° conical bore and a union nut, both according to ISO 8434-1.

Versatility and Flexibility

Users benefit from the great versatility and flexibility of the system, as well as the many combination and adaptation options offered by using standard components from the STAUFF Connect product range.

There is therefore no need to duplicate the stock-keeping of similar components with a correspondingly high likelihood of confusion, as is often the case with comparable systems. Material and logistics costs can thus be correspondingly reduced.

Materials and Surface Finishing

Like all other components in the STAUFF Connect product range, STAUFF Form Rings are designed as standard with a high-quality zinc/nickel surface coating.

With over 1,200 hours of resistance to red rust / base metal corrosion in the salt-spray chamber in accordance with DIN EN ISO 9227, the coating offers most reliable corrosion protection far beyond previously accepted market standards.

Even after shipping, handling and assembly of the components, the coating significantly exceeds the requirements for the highest corrosion protection class K5 defined in VDMA Standard Sheet 24576 for tube connectors.

Sealing

The sealing of the only possible leakage path is provided primarily by the large-volume elastomeric sealing fitted to the STAUFF Form Ring, which is specifically positioned between the surface of the tube and the 24° conical bore of the fitting body during assembly.

FKM (Viton®) is used as the standard sealing material and enables problem-free use of the STAUFF Form tube forming system for challenging applications involving high temperatures or aggressive media.

The unique sealing profile has a particularly large cross-section in order to provide a safe, reliable and permanent seal even in the event of unfavourable tolerances of the tube and fitting. The sealing effect is assisted by the system pressure of the hydraulic system so that the STAUFF Form tube forming system is also the perfect choice for high-pressure applications.

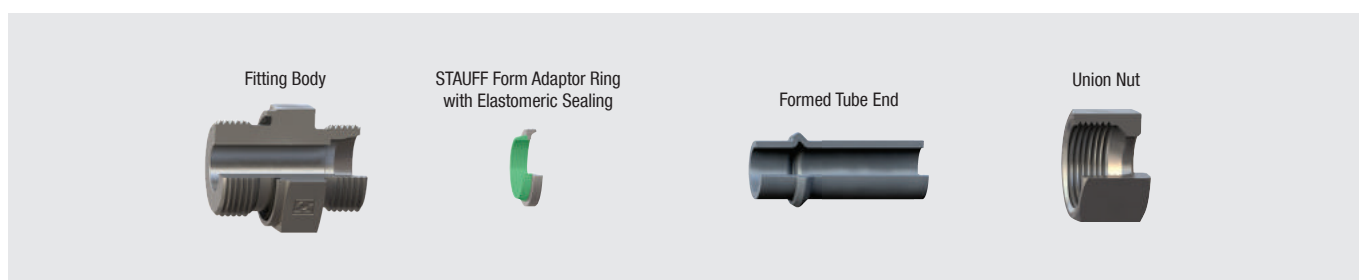

Main Features and Benefits

- Suitable for both steel and stainless steel tubing as standard – also applicable for alternative tube materials on request
- Covers all common metric tube dimensions from 6 x 1.5 mm to 42 x 4 mm in the Light Series and 38 x 6 mm in the Heavy Series respectively
- Requires only standard parts from the STAUFF Connect range according to ISO 8434-1: No need to duplicate the stock-keeping of similar components with a correspondingly high likelihood of confusion
- High-quality zinc/nickel surface coating provides maximum protection and corrosion resistance – standard for all parts in the STAUFF Connect range
- Positive-locking connection with a large-volume elastomeric sealing providing a safe, reliable and permanent seal even in the event of unfavourable tolerances
- The use of FKM (Viton®) as the standard seal material makes the system perfect for the most challenging applications
- Suitable for nominal pressures up to 800 bar in the Heavy Series – designed with four-fold safety and maximum tear-out strength
- Incredibly simple final assembly in the fitting body with low assembly torques as well as short assembly paths (once the fixed point has been reached) with a minimised risk of over-assembly

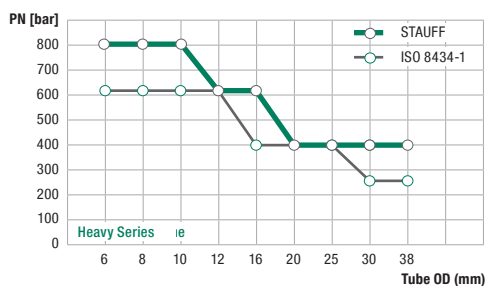
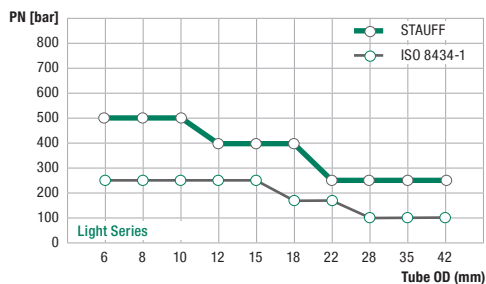

Nominal pressure levels of tube fittings

Pressure Resistance

When the STAUFF Form tube forming system is used in conjunction with genuine products from the STAUFF Connect product range, it provides pressure resistance of up to 800 bar / 11600 PSI in the Heavy Series and 500 bar / 7250 PSI in the Light Series (generally with a four-fold safety factor and depending on the series, design and size of the fitting body and taking into consideration various pressure reducing factors).

This is the result of exceptional care taken in the development of the system and the selection, handling and processing of the raw materials.

Maximum tear-out strength can be guaranteed for the system due to the contour shaped at the tube end.

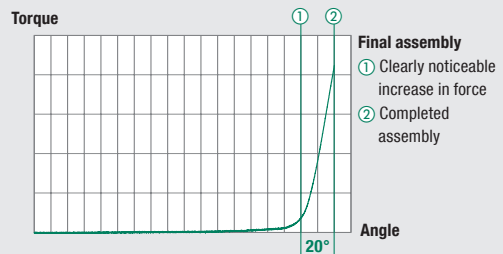

Final Assembly in the Fitting Body

Final assembly is performed by tightening the union nut until the point with clearly noticeable increase in force (fixed point). The assembly is completed with another turn by approximately 15° to 20° beyond this point.

This incredibly simple assembly method has several benefits for the user:

- Considerably lower torques and short assembly paths (once the fixed point has been reached)
- Significant increase in torque to clearly indicate the end of the assembly
- Maximum safety to combat over-assembly
- No need for time-consuming and expensive training

Connections made with the STAUFF Form can be untightened as often as required and reassembled without wear, as any damaging expansion of the 24° conical bore of the fitting body is technically avoided.



37° Flared Tube Fittings

A

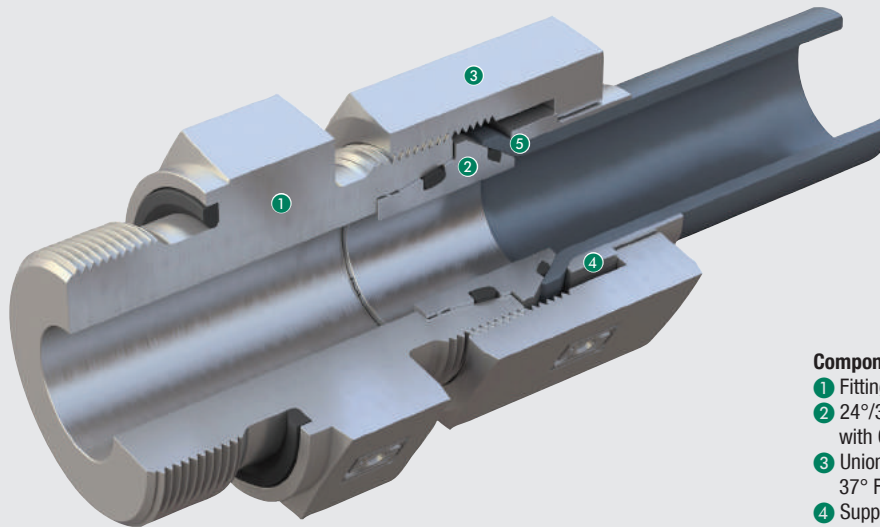

Components

- ① Fitting Body – ISO 8434-1
- ② 24°/37° Flared Cone Adaptor with O-Rings – DIN 3949
- ③ Union Nut for 37° Flared Tube Fittings – DIN 3949
- ④ Support Sleeve – DIN 3949
- ⑤ 37° Flared Tube End – DIN 3949

STAUFF Connect 37° Flared Tube Fittings have been developed and designed for the reliable, leak-free connection of tubes with a 37° flare with conventional fitting bodies with a 24° cone according to ISO 8434-1.

Thanks to the optimised geometry of STAUFF Connect 37° Flared Tube Fittings with metallic/elastomer sealing at the contact points both to the fitting body and the tube, efficient sealing is ensured, even if there are vibrations and pressure fluctuations / peaks.

STAUFF Connect 37° Flared Tube Fittings can be used in applications with nominal pressures up to 500 bar / 7250 PSI on the Light Series or up to 630 bar / 9135 PSI in the Heavy Series (pressure reduction factors to be considered).

Fitting Body



24°/ 37° Flared Cone Adaptor with O-Rings



37° Flared Tube End

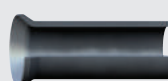

Support Sleeve



Union Nut for 37° Flared Tube Fittings

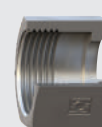

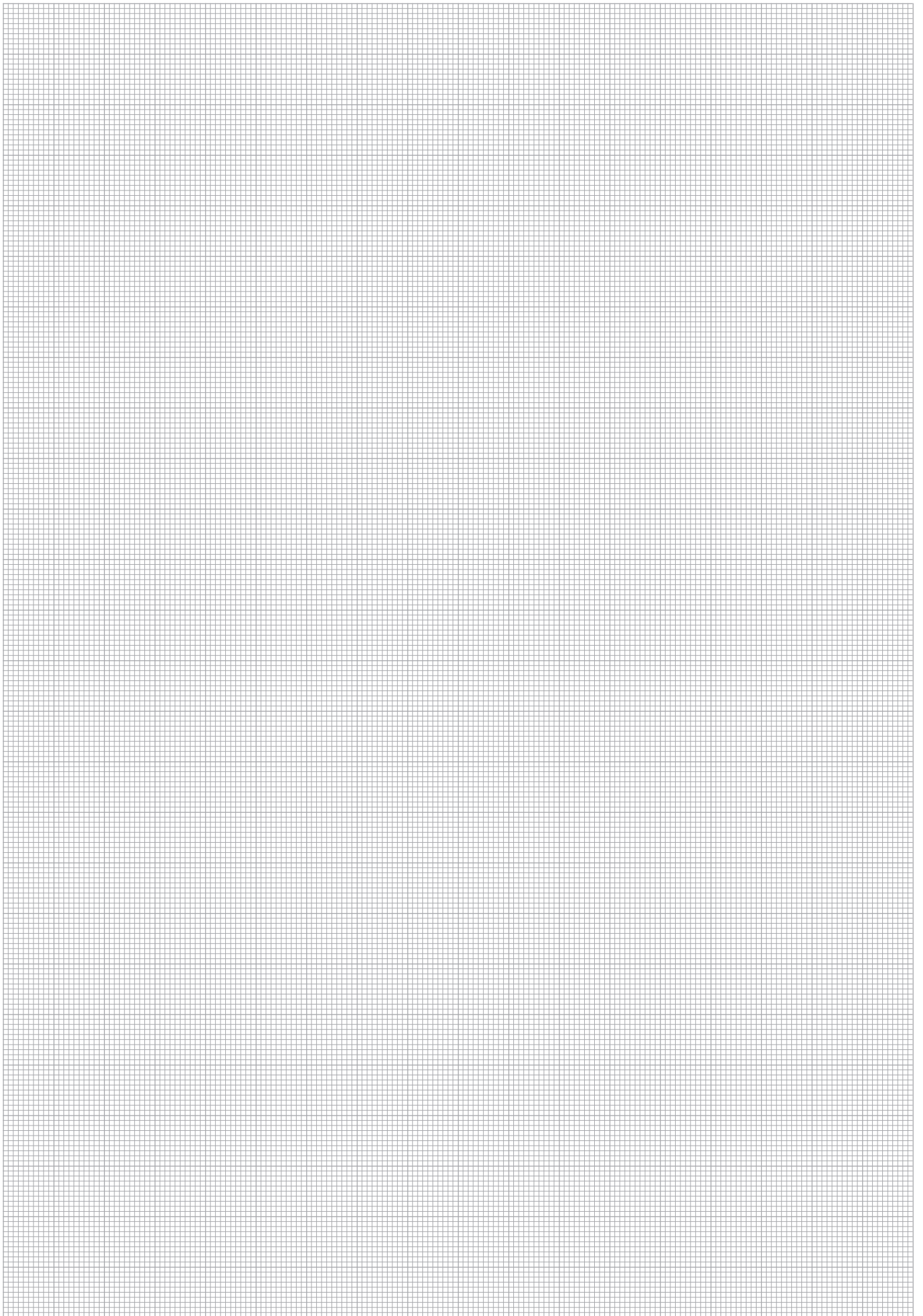



	Double Edge Cutting Ring FI-DS	26
	Soft-Sealing Cutting Ring FI-WDDS	27
	Support Sleeve FI-VH	28
	STAUFF Form Adaptor Ring FI-AR	30
	Union Nut FI-M	31
	24°/37° Flared Cone Adaptor with O-Rings FI-BA	32
	Support Sleeve for 37° Flared Tube Fittings FI-BH	33
	Union Nut for 37° Flared Tube Fittings FI-BM	34
	37° Flared Tube Fitting Set FI-AB	35

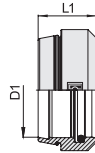

**Soft-Sealing Cutting Ring
Type FI-WDDS • Series L / S**

B

Series	Tube OD	PN	Dimensions		Weight (^{kg} / _{lbs}) ca. per 100 ²	Ordering Codes Soft-Sealing Cutting Ring
	(^{mm} / _{in}) D1		(^{bar} / _{PSI})	(^{mm} / _{in}) L1		
L	6	500	8,8		0,19	FI-WDDS-06L/S-V-W3
	.24	7250	.35		.42	
	8	500	8,8		0,24	FI-WDDS-08L/S-V-W3
	.31	7250	.35		.53	
	10	500	9,8		0,35	FI-WDDS-10L/S-V-W3
	.39	7250	.39		.77	
	12	400	9,8		0,41	FI-WDDS-12L/S-V-W3
	.47	5800	.39		.90	
	15	400	10,2		0,66	FI-WDDS-15L-V-W3
	.59	5800	.40		1.44	
	18	400	10,2		0,82	FI-WDDS-18L-V-W3
	.71	5800	.40		1.79	
	22	250	11,5		1,06	FI-WDDS-22L-V-W3
	.87	3625	.45		2.34	
	28	250	11,5		1,28	FI-WDDS-28L-V-W3
	1.10	3625	.45		2.82	
	35	250	13,5		2,36	FI-WDDS-35L-V-W3
	1.38	3625	.53		5.18	
42	250	13,5		2,75	FI-WDDS-42L-V-W3	
1.65	3625	.53		6.05		
S	6	800	8,8		0,19	FI-WDDS-06L/S-V-W3
	.24	11600	.35		.42	
	8	800	8,8		0,24	FI-WDDS-08L/S-V-W3
	.31	11600	.35		.53	
	10	800	9,8		0,35	FI-WDDS-10L/S-V-W3
	.39	11600	.39		.77	
	12	630	9,8		0,41	FI-WDDS-12L/S-V-W3
	.47	9135	.39		.90	
	14	630	10,2		0,73	FI-WDDS-14S-V-W3
	.55	9135	.40		1.61	
	16	630	10,3		0,83	FI-WDDS-16S-V-W3
	.63	9135	.41		1.82	
	20	400	12,5		1,28	FI-WDDS-20S-V-W3
	.79	5800	.49		2.81	
	25	400	12,5		1,58	FI-WDDS-25S-V-W3
	.98	5800	.49		3.48	
	30	400	13,5		2,41	FI-WDDS-30S-V-W3
	1.18	5800	.53		5.31	
38	400	13,5		3,00	FI-WDDS-38S-V-W3	
1.50	5800	.53		6.60		

Ordering Codes
***FI-WDDS*-10*L*-V*-W3**

* Soft-Sealing Cutting Ring		FI-WDDS
* Outside Tube Diameter D1 (in mm)		-10
* Series	Light Series	L
	Heavy Series	S
* Seal Material	FKM (Viton®)	-V
* Material Code	Steel, zinc/nickel-plated	-W3

Please contact STAUFF for alternative materials and surface finishings.

Standard seal material is FKM (Viton®).



Support Sleeve
Type FI-VH

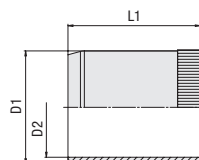

B

Ordering Codes

***FI-VH*-10*x1.5*-W69**

- * Support Sleeve **FI-VH**
- * Outside Tube Diameter (in mm) **-10**
- * Wall Thickness (in mm) **x1.5**
- * Material Code Brass **-W69**

Please contact STAUFF for alternative materials and surface finishings.

Dimensions (mm/in)	D1	D2	L1	Ordering Codes
6 x 1	4	2,6	15,5	FI-VH-06x1-W69
.24 x .04	.16	.10	.61	
6 x 0,75	4,5	3,1	12,5	FI-VH-06x0.75-W69
.24 x .03	.18	.12	.49	
6 x 0,5	5	3,6	12,5	FI-VH-06x0.5-W69
.24 x .02	.20	.14	.49	
8 x 1	6	4,6	15,5	FI-VH-08x1-W69
.31 x .04	.24	.18	.61	
8 x 0,75	6,5	5,1	12,5	FI-VH-08x0.75-W69
.31 x .03	.26	.20	.49	
10 x 1,5	7	5,6	17	FI-VH-10x1.5-W69
.39 x .06	.28	.22	.67	
10 x 1	8	6,6	16,5	FI-VH-10x1-W69
.39 x .04	.31	.26	.65	
10 x 0,75	8,5	7,1	16,5	FI-VH-10x0.75-W69
.39 x .03	.33	.28	.65	
12 x 1,5	9	7,6	16,5	FI-VH-12x1.5-W69
.47 x .06	.35	.30	.65	
12 x 1	10	8,6	16,5	FI-VH-12x1-W69
.47 x .04	.39	.34	.65	
12 x 0,75	10,5	9,3	16,5	FI-VH-12x0.75-W69
.47 x .03	.41	.37	.65	
14 x 1	12	10,2	18	FI-VH-14x1-W69
.55 x .04	.47	.40	.71	
15 x 1,5	12	10,2	17	FI-VH-15x1.5-W69
.59 x .06	.47	.40	.67	
15 x 1	13	11,2	17	FI-VH-15x1-W69
.59 x .04	.51	.44	.67	
18 x 1,5	15	13,2	17,5	FI-VH-18x1.5-W69
.71 x .06	.59	.52	.69	
18 x 1	16	14,2	17,5	FI-VH-18x1-W69
.71 x .04	.63	.56	.69	
20 x 1	18	16,2	22	FI-VH-20x1-W69
.79 x .04	.71	.64	.87	
22 x 1,5	19	17,2	18	FI-VH-22x1.5-W69
.87 x .06	.75	.68	.71	
22 x 1	20	18,2	18	FI-VH-22x1-W69
.87 x .04	.79	.72	.71	
25 x 1,5	22	20,2	23,5	FI-VH-25x1.5-W69
.98 x .06	.87	.80	.93	
25 x 1	23	21,2	23,5	FI-VH-25x1-W69
.98 x .04	.91	.83	.93	
28 x 2	24	22,2	23,5	FI-VH-28x2-W69
1.10 x .08	.94	.87	.93	
28 x 1,5	25	23,2	23,5	FI-VH-28x1.5-W69
1.10 x .06	.98	.91	.93	
28 x 1	26	24,2	23,5	FI-VH-28x1-W69
1.10 x .04	1.02	.95	.93	
35 x 2	31	28,8	23,5	FI-VH-35x2-W69
1.38 x .08	1.22	1.13	.93	
35 x 1,5	32	29,8	23,5	FI-VH-35x1.5-W69
1.38 x .06	1.26	1.17	.93	
35 x 1	33	30,8	23,5	FI-VH-35x1-W69
1.38 x .04	1.30	1.21	.93	
42 x 2	38	35,8	23,5	FI-VH-42x2-W69
1.65 x .08	1.50	1.41	.93	
42 x 1,5	39	36,8	23,5	FI-VH-42x1.5-W69
1.65 x .06	1.54	1.45	.93	



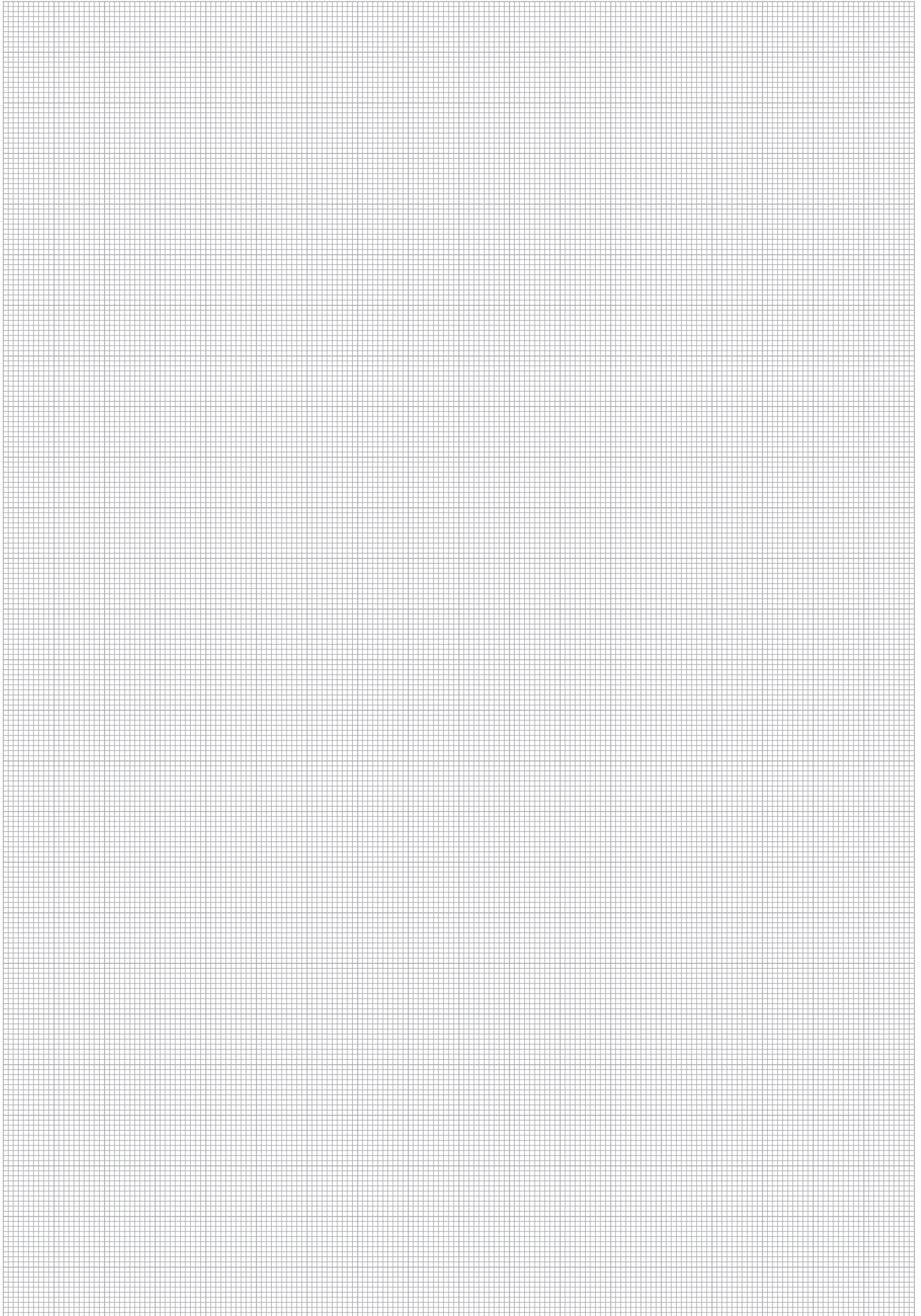

**STAUFF Form Adaptor Ring
Type FI-AR ▪ Series L / S**

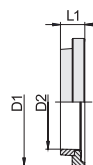

B

Ordering Codes

***FI-AR*-10*L*-V*-W3**

* STAUFF Form Ring with Integrated Elastomeric Sealing

FI-AR

* Outside Tube Diameter D1 (in mm)

-10

* Series Light Series Heavy Series

L S

* Seal Material FKM (Viton®)

-V

* Material Code Steel, zinc/nickel-plated

-W3

Please contact STAUFF for alternative materials and surface finishings.

Series	Tube OD		Dimensions			Weight (kg/lbs) ca. per 100 ²	Ordering Codes
	(mm/in)	(bar/psi)	(mm/in)				
	D1		D2		L1		
L	6	500	10,2		5,3	0,09	FI-AR-06L/S-V-W3
	.24	7250	.40		.21	.20	
	8	500	12,2		5,3	0,1	FI-AR-08L/S-V-W3
	.31	7250	.48		.21	.22	
	10	500	14,2		5,9	0,17	FI-AR-10L/S-V-W3
	.39	7250	.56		.23	.37	
	12	400	16,2		5,9	0,19	FI-AR-12L/S-V-W3
	.47	5800	.64		.23	.42	
	15	400	20,2		5,3	0,23	FI-AR-15L-V-W3
	.59	5800	.80		.21	.51	
	18	400	24,2		5	0,29	FI-AR-18L-V-W3
	.71	5800	.95		.20	.64	
	22	250	27,2		6	0,42	FI-AR-22L-V-W3
	.87	3625	1.07		.24	.92	
	28	250	33,2		6	0,52	FI-AR-28L-V-W3
	1.10	3625	1.31		.24	1.14	
	35	250	42,2		6,3	0,94	FI-AR-35L-V-W3
	1.38	3625	1.66		.25	2.07	
	42	250	49,5		8	1,09	FI-AR-42L-V-W3
	1.65	3625	1.95		.31	2.40	
S	6	800	10,2		5,3	0,09	FI-AR-06L/S-V-W3
	.24	11600	.40		.21	.20	
	8	800	12,2		5,3	0,1	FI-AR-08L/S-V-W3
	.31	11600	.48		.21	.22	
	10	800	14,2		5,9	0,17	FI-AR-10L/S-V-W3
	.39	11600	.56		.23	.37	
	12	630	16,2		5,9	0,19	FI-AR-12L/S-V-W3
	.47	9135	.64		.23	.42	
	16	630	22,2		5	0,26	FI-AR-16S-V-W3
	.63	9135	.87		.20	.57	
	20	400	27,2		5,2	0,42	FI-AR-20S-V-W3
	.79	5800	1.07		.20	.92	
	25	400	33,2		6	0,69	FI-AR-25S-V-W3
	.98	5800	1.31		.24	1.52	
	30	400	37,2		6,3	0,79	FI-AR-30S-V-W3
	1.18	5800	1.46		.25	1.74	
	38	400	49,5		8	1,79	FI-AR-38S-V-W3
	1.50	5800	1.95		.31	3.94	

Standard seal material is FKM (Viton®).

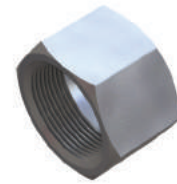
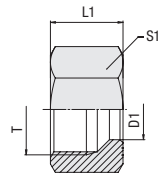

Union Nut
 Type FI-M • Series LL / L / S

B

Series	Tube OD		Dimensions (mm/in)	L1	S1	Weight (kg/lbs) ca. per 100 ²	Ordering Codes	
	(mm/in)	PN (bar/PSI)						Thread T
LL	4	100	M 8 x 1	11	10	0,40	FI-M-04LL-W3	
	.16	1450		.43	.39	.88		
	6	100	M 10 x 1	11,5	12	0,50	FI-M-06LL-W3	
	.24	1450		.45	.47	1.10		
	8	100	M 12 x 1	12	14	0,70	FI-M-08LL-W3	
	.31	1450		.47	.55	1.54		
	10	100	M 14 x 1	12,5	17	1,10	FI-M-10LL-W3	
	.39	1450		.49	.67	2.42		
	12	100	M 16 x 1	13	19	1,30	FI-M-12LL-W3	
	.47	1450		.51	.75	2.86		
	L	6	500	M 12 x 1,5	14,5	14	0,90	FI-M-06L-W3
		.24	7250		.57	.55	1.98	
8		500	M 14 x 1,5	14,5	17	1,40	FI-M-08L-W3	
.31		7250		.57	.67	3.08		
10		500	M 16 x 1,5	15,5	19	1,70	FI-M-10L-W3	
.39		7250		.61	.75	3.74		
12		400	M 18 x 1,5	15,5	22	2,40	FI-M-12L-W3	
.47		5800		.61	.87	5.28		
15		400	M 22 x 1,5	17	27	4,10	FI-M-15L-W3	
.59		5800		.67	1.06	9.02		
18		400	M 26 x 1,5	18	32	6,00	FI-M-18L-W3	
.71		5800		.71	1.26	13.20		
22		250	M 30 x 2	20	36	8,00	FI-M-22L-W3	
.87		3625		.79	1.42	17.60		
28		250	M 36 x 2	22	41	14,20	FI-M-28L-W3	
1.10		3625		.87	1.61	31.24		
35		250	M 45 x 2	25	50	19,80	FI-M-35L-W3	
1.38		3625		.98	1.97	43.56		
42	250	M 52 x 2	25	60	22,00	FI-M-42L-W3		
1.65	3625		.98	2.36	48.40			
S	6	800	M 14 x 1,5	16,5	17	1,70	FI-M-06S-W3	
	.24	11600		.65	.67	3.74		
	8	800	M 16 x 1,5	16,5	19	2,00	FI-M-08S-W3	
	.31	11600		.65	.75	4.40		
	10	800	M 18 x 1,5	17,5	22	3,00	FI-M-10S-W3	
	.39	11600		.69	.87	6.60		
	12	630	M 20 x 1,5	17,5	24	3,40	FI-M-12S-W3	
	.47	9135		.69	.94	7.48		
	14	630	M 22 x 1,5	20,5	27	5,20	FI-M-14S-W3	
	.55	9135		.81	1.06	11.44		
	16	630	M 24 x 1,5	20,5	30	6,50	FI-M-16S-W3	
	.63	9135		.81	1.18	14.30		
	20	400	M 30 x 2	24	36	10,10	FI-M-20S-W3	
	.79	5800		.94	1.42	22.22		
	25	400	M 36 x 2	27	46	19,80	FI-M-25S-W3	
	.98	5800		1.06	1.81	43.56		
	30	400	M 42 x 2	29	50	21,60	FI-M-30S-W3	
	1.18	5800		1.14	1.97	47.52		
38	400	M52 x 2	32,5	60	31,40	FI-M-38S-W3		
1.50	5800		1.28	2.36	69.08			

Ordering Codes

***FI-M*-10*L*-W3**

* Union Nut		FI-M
* Outside Tube Diameter D1 (in mm)		-10
* Series	Light Series	L
	Heavy Series	S
* Material Code	Steel, zinc/nickel-plated	-W3

Please contact STAUFF for alternative materials and surface finishings.



24°/37° Flared Cone Adaptor with O-Rings
Type FI-BA ▪ Series L / S

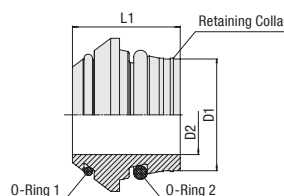

B

Ordering Codes

***FI-BA*-10*L*-B*-W3**

* 24°/37° Flared Cone Adaptor with O-Rings

FI-BA

* Outside Tube Diameter D1 (in mm)

-10

* Series
 Light Series
 Heavy Series

L
S

* Seal Material
 NBR (Buna-N®)
 FKM (Viton®)
 EPDM

-B
-V
-E

* Material Code
 Steel, zinc/nickel-plated

-W3

Please contact STAUFF for alternative materials and surface finishings.

Spare Parts / Accessories



O-Ring
 Type **O-RING**

Page 207

Series	Tube OD PN		Dimensions				Weight (^{kg} /lbs) ca. per 100	Ordering Codes
	(mm/in) D1	(^{bar} /psi)	(mm/in) D2	L1	O-Ring 1	O-Ring 2		
L	6	500	3	11,5	4,4 x 0,8	4,5 x 1,5	0,28	FI-BA-06L/S-B-W3
	.24	7250	.12	.45	.17 x .03	.18 x .06	.62	
	8	500	5	12	6,0 x 0,8	6,5 x 1,5	0,40	FI-BA-08L/S-B-W3
	.31	7250	.20	.47	.24 x .03	.26 x .06	.89	
	10	500	6	12,5	7,5 x 0,8	8,5 x 1,5	0,65	FI-BA-10L/S-B-W3
	.39	7250	.24	.49	.30 x .03	.33 x .06	1.43	
	12	400	8	12,5	9,5 x 0,8	10,0 x 1,5	0,80	FI-BA-12L/S-B-W3
	.47	5800	.31	.49	.37 x .03	.39 x .06	1.76	
	15	400	11	12,5	12,5 x 0,8	12,5 x 2,0	1,05	FI-BA-15L-B-W3
	.59	5800	.43	.49	.49 x .03	.49 x .08	2.31	
	18	400	14	13	15,0 x 1,0	16,0 x 2,0	1,26	FI-BA-18L-B-W3
	.71	5800	.55	.51	.59 x .04	.63 x .08	2.77	
	22	250	17	14,2	18,0 x 1,0	20,0 x 2,0	2,01	FI-BA-22L-B-W3
	.87	3625	.67	.56	.71 x .04	.79 x .08	4.43	
	28	250	23	14,7	23,0 x 1,0	26,0 x 2,0	2,82	FI-BA-28L-B-W3
	1.10	3625	.91	.58	.91 x .04	1.02 x .08	6.20	
	35	250	28	18,5	30,0 x 1,0	32,0 x 2,5	5,86	FI-BA-35L-B-W3
	1.38	3625	1.10	.73	1.18 x .04	1.26 x .10	12.88	
42	250	35	20,5	37,0 x 1,0	38,0 x 2,5	4,40	FI-BA-42L-B-W3	
1.65	3625	1.38	.81	1.46 x .04	1.50 x .10	9.69		
S	6	630	3	11,5	4,4 x 0,8	4,5 x 1,5	0,28	FI-BA-06L/S-B-W3
	.24	9135	.12	.45	.17 x .03	.18 x .06	.62	
	8	630	5	12	6,0 x 0,8	6,5 x 1,5	0,40	FI-BA-08L/S-B-W3
	.31	9135	.20	.47	.24 x .03	.26 x .06	.89	
	10	630	6	12,5	7,5 x 0,8	8,5 x 1,5	0,65	FI-BA-10L/S-B-W3
	.39	9135	.24	.49	.30 x .03	.33 x .06	1.43	
	12	630	8	12,5	9,5 x 0,8	10,0 x 1,5	0,80	FI-BA-12L/S-B-W3
	.47	9135	.31	.49	.37 x .03	.39 x .06	1.76	
	14	630	9	14	11,0 x 1,0	12,0 x 2,0	1,20	FI-BA-14S-B-W3
	.55	9135	.35	.55	.43 x .04	.47 x .08	2.63	
	16	630	11	15	12,5 x 1,0	14,0 x 2,0	1,50	FI-BA-16S-B-W3
	.63	9135	.43	.59	.49 x .04	.55 x .08	3.30	
	20	400	14	18,5	16,0 x 1,0	17,3 x 2,4	2,73	FI-BA-20S-B-W3
	.79	5800	.55	.73	.63 x .04	.68 x .09	6.00	
	25	400	19	20	20,0 x 1,0	22,3 x 2,4	3,78	FI-BA-25S-B-W3
	.98	5800	.75	.79	.79 x .04	.88 x .09	8.32	
	30	400	23	22	25,0 x 1,0	27,3 x 2,4	3,82	FI-BA-30S-B-W3
	1.18	5800	.91	.87	.98 x .04	1.07 x .09	8.41	
38	400	30	26	32,0 x 1,8	35,0 x 2,4	9,15	FI-BA-38S-B-W3	
1.50	5800	1.18	1.02	1.26 x .07	1.38 x .09	20.13		

Standard seal material is NBR (Buna-N®).

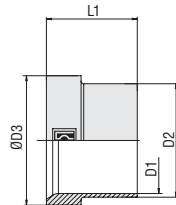

Support Sleeve for 37° Flared Tube Fittings
 Type FI-BH ■ Series L / S

B

Series	Tube OD PN		Dimensions			Weight (^{kg} / _{lbs}) ca. per 100	Ordering Codes
	(mm/in)	(^{bar} / _{PSI})	(mm/in)	D3	L1		
	D1		D2				
L	6	500	7,6	10,2	10	0,21	FI-BH-06L/S-W3
	.24	7250	.30	.40	.39	.46	
	8	500	9,3	12,2	11	0,25	FI-BH-08L/S-W3
	.31	7250	.37	.48	.43	.56	
	10	500	11,5	14,2	12	0,37	FI-BH-10L/S-W3
	.39	7250	.45	.56	.47	.82	
	12	400	13,6	16,2	12,5	0,46	FI-BH-12L/S-W3
	.47	5800	.54	.64	.49	1.01	
	15	400	17,5	20,2	13,5	0,89	FI-BH-15L-W3
	.59	5800	.69	.80	.53	1.96	
	18	400	21	24,2	14	1,40	FI-BH-18L-W3
	.71	5800	.83	.95	.55	3.08	
	22	250	24,2	27,8	17,5	1,59	FI-BH-22L-W3
	.87	3625	.95	1.09	.69	3.49	
	28	250	30,2	33,8	16,5	1,99	FI-BH-28L-W3
	1.10	3625	1.19	1.33	.65	4.38	
	35	250	38	42,7	18,5	3,70	FI-BH-35L-W3
	1.38	3625	1.50	1.68	.73	8.14	
	42	250	45	49,7	20,5	4,94	FI-BH-42L-W3
	1.65	3625	1.77	1.96	.81	10.86	
S	6	630	7,6	10,2	10	0,21	FI-BH-06L/S-W3
	.24	9135	.30	.40	.39	.46	
	8	630	9,3	12,2	11	0,25	FI-BH-08L/S-W3
	.31	9135	.37	.48	.43	.56	
	10	630	11,5	14,2	12	0,37	FI-BH-10L/S-W3
	.39	9135	.45	.56	.47	.82	
	12	630	13,6	16,2	12,5	0,46	FI-BH-12L/S-W3
	.47	9135	.54	.64	.49	1.01	
	14	630	17,5	20,2	14	1,20	FI-BH-14S-W3
	.55	9135	.69	.80	.55	2.63	
	16	630	18,5	22	16,5	1,25	FI-BH-16S-W3
	.63	9135	.73	.87	.65	2.74	
	20	400	24,2	27,8	17	2,39	FI-BH-20S-W3
	.79	5800	.95	1.09	.67	5.26	
	25	400	28,5	32,8	19,5	2,98	FI-BH-25S-W3
	.98	5800	1.12	1.29	.77	6.55	
	30	400	34	39	21	4,50	FI-BH-30S-W3
	1.18	5800	1.34	1.54	.83	9.91	
	38	400	42	48,5	26	7,34	FI-BH-38S-W3
	1.50	5800	1.65	1.91	1.02	16.15	

Ordering Codes

***FI-BH*-10*L*-W3**

- * Support Sleeve for 37° Flared Tube Fittings FI-BH
- * Outside Tube Diameter D1 (in mm) -10
- * Series L
S
- * Material Code Steel, zinc/nickel-plated -W3

Please contact STAUFF for alternative materials and surface finishings.



Union Nut for 37° Flared Tube Fittings
Type FI-BM ▪ Series L / S

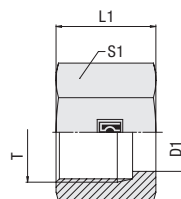

B

Ordering Codes

***FI-BM*-10*L*-W3**

* Union Nut for 37° Flared Tube Fittings

* Outside Tube Diameter D1 (in mm)

* Series Light Series
 Heavy Series

* Material Code Steel, zinc/nickel-plated

Please contact STAUFF for alternative materials and surface finishings.

FI-BM
-10
L
S
-W3

Series	Tube OD (mm/in)	PN (bar/psi)	Dimensions (mm/in)			Weight (kg/lbs) ca. per 100	Ordering Codes	
			Thread T	D1	L1			S1
L	6	500	M 12 x 1,5	7,8	17	14	1,07	FI-BM-06L-W3
	.24	7250		.31	.67	.55	2.35	
	8	500	M 14 x 1,5	9,5	18	17	1,82	FI-BM-08L-W3
	.31	7250		.37	.71	.67	4.01	
	10	500	M 16 x 1,5	11,7	19,5	19	2,35	FI-BM-10L-W3
	.39	7250		.46	.77	.75	5.18	
	12	400	M 18 x 1,5	13,8	20,5	22	3,36	FI-BM-12L-W3
	.47	5800		.54	.81	.87	7.38	
	15	400	M 22 x 1,5	17,7	23	27	5,31	FI-BM-15L-W3
	.59	5800		.70	.91	1.06	11.68	
	28	400	M 26 x 1,5	21,2	23	32	7,22	FI-BM-18L-W3
	1.10	5800		.83	.91	1.26	15.88	
	22	250	M 30 x 2	24,4	27,5	36	10,60	FI-BM-22L-W3
	.87	3625		.96	1.08	1.42	23.32	
	18	250	M 36 x 2	30,4	27,5	41	11,47	FI-BM-28L-W3
	.71	3625		1.20	1.08	1.61	25.24	
	35	250	M 45 x 2	38,3	30	50	16,27	FI-BM-35L-W3
	1.38	3625		1.51	1.18	1.97	35.80	
42	250	M 52 x 2	45,3	34	60	30,39	FI-BM-42L-W3	
1.65	3625		1.78	1.34	2.36	66.86		
S	6	630	M 14 x 1,5	7,8	18	17	2,03	FI-BM-06S-W3
	.24	9135		.31	.71	.67	4.46	
	8	630	M 16 x 1,5	9,5	19	19	2,52	FI-BM-08S-W3
	.31	9135		.37	.75	.75	5.54	
	10	630	M 18 x 1,5	11,7	20,5	22	3,58	FI-BM-10S-W3
	.39	9135		.46	.81	.87	7.88	
	12	630	M 20 x 1,5	13,8	21	24	4,11	FI-BM-12S-W3
	.47	9135		.54	.83	.94	9.05	
	14	630	M 22 x 1,5	17,7	23	27	5,38	FI-BM-14S-W3
	.55	9135		.70	.91	1.06	11.84	
	16	630	M 24 x 1,5	18,7	26,5	30	7,87	FI-BM-16S-W3
	.63	9135		.74	1.04	1.18	17.31	
	20	400	M 30 x 2	24,4	27,5	36	10,61	FI-BM-20S-W3
	.79	5800		.96	1.08	1.42	23.35	
	25	400	M 36 x 2	28,7	30,5	46	22,19	FI-BM-25S-W3
	.98	5800		1.13	1.20	1.81	48.81	
	30	400	M 42 x 2	34,2	32	50	23,20	FI-BM-30S-W3
	1.18	5800		1.35	1.26	1.97	51.04	
38	400	M 52 x 2	42,3	38	60	35,40	FI-BM-38S-W3	
1.50	5800		1.67	1.50	2.36	77.89		

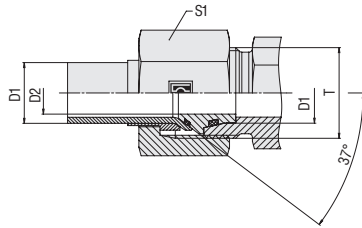

37° Flared Tube Fitting Set
Type FI-AB ■ Series L / S

B

Series	Tube OD PN		Dimensions			Weight (^{kg} / _{lbs}) ca. per 100	Ordering Codes
	(mm/in)	(^{bar} / _{PSI})	(mm/in)	Thread T	D2		
L	6	500	M 12 x 1,5	3	14	1,74	FI-AB-06L-B-W3
	.24	7250		.12	.55	3,83	
	8	500	M 14 x 1,5	5	17	2,50	FI-AB-08L-B-W3
	.31	7250		.20	.67	5,50	
	10	500	M 16 x 1,5	6	19	3,38	FI-AB-10L-B-W3
	.39	7250		.24	.75	7,43	
	12	400	M 18 x 1,5	8	22	4,83	FI-AB-12L-B-W3
	.47	5800		.31	.87	10,62	
	15	400	M 22 x 1,5	11	27	4,66	FI-AB-15L-B-W3
	.59	5800		.43	1.06	10,24	
	18	400	M 26 x 1,5	14	32	10,11	FI-AB-18L-B-W3
	.71	5800		.55	1.26	22,25	
	22	250	M 30 x 2	17	36	14,25	FI-AB-22L-B-W3
	.87	3625		.67	1.42	31,35	
	28	250	M 36 x 2	23	41	16,47	FI-AB-28L-B-W3
	1.10	3625		.91	1.61	36,23	
	35	250	M 45 x 2	28	50	25,86	FI-AB-35L-B-W3
	1.38	3625		1.10	1.97	56,90	
42	250	M 52 x 2	35	60	42,85	FI-AB-42L-B-W3	
1.65	3625		1.38	2.36	94,27		
S	6	630	M 14 x 1,5	3	17	2,51	FI-AB-06S-B-W3
	.24	9135		.12	.67	5,53	
	8	630	M 16 x 1,5	5	19	3,39	FI-AB-08S-B-W3
	.31	9135		.20	.75	7,46	
	10	630	M 18 x 1,5	6	22	4,77	FI-AB-10S-B-W3
	.39	9135		.24	.87	10,49	
	12	630	M 20 x 1,5	8	24	5,63	FI-AB-12S-B-W3
	.47	9135		.31	.94	12,39	
	14	630	M 22 x 1,5	9	27	7,77	FI-AB-14S-B-W3
	.55	9135		.35	1.06	17,10	
	16	630	M 24 x 1,5	11	30	10,88	FI-AB-16S-B-W3
	.63	9135		.43	1.18	23,94	
	20	400	M 30 x 2	14	36	15,90	FI-AB-20S-B-W3
	.79	5800		.55	1.42	34,98	
	25	400	M 36 x 2	19	46	29,34	FI-AB-25S-B-W3
	.98	5800		.75	1.81	64,54	
	30	400	M 42 x 2	23	50	33,64	FI-AB-30S-B-W3
	1.18	5800		.91	1.97	74,00	
38	400	M 52 x 2	30	60	52,40	FI-AB-38S-B-W3	
1.50	5800		1.18	2.36	115,28		

Standard seal material is NBR (Buna-N®).

Ordering Codes
***FI-AB*-10*L*-B*-W3**

* 37° Flared Tube Fitting Set		FI-AB
* Outside Tube Diameter D1 (in mm)		-10
* Series	Light Series	L
	Heavy Series	S
* Seal Material	NBR (Buna-N®)	-B
	FKM (Viton®)	-V
	EPDM	-E
* Material Code	Steel, zinc/nickel-plated	-W3

Please contact STAUFF for alternative materials and surface finishings.

Spare Parts / Accessories

 O-Ring
 Type **O-RING**





Page 207





Straight Male Stud Fitting 38-61

FI-GE

	Whitworth Parallel Pipe Thread (BSPP) / Metallic Sealing Edge FI-GE-...-R	38
	Metric Parallel Thread / Metallic Sealing Edge FI-GE-...-M	42
	Whitworth Parallel Pipe Thread (BSPP) / Profile Sealing Ring FI-GE-...-R-WD	44
	Metric Parallel Thread / Profile Sealing Ring FI-GE-...-M-WD	48
	BSPP Thread / 60° Conical Bore / Sealing Surface for Gaskets FI-GE-...-R-DF	50
	Metric Parallel Thread / O-Ring FI-GE-...-M-OR	52
	Whitworth Taper Pipe Thread (BSPT) FI-GE-...-Rk	54
	Metric Taper Thread FI-GE-...-Mk	56
	NPT Thread FI-GE-...-N	58
	UN/UNF Thread / O-Ring FI-GE-...-U	60

Male Stud Elbow
 FI-WE

62-67

**Whitworth Parallel Pipe Thread (BSPP) /
 Metallic Sealing Edge**
 FI-WE-...-R

62

**Metric Parallel Thread /
 Metallic Sealing Edge**
 FI-WE-...-M

63

Whitworth Taper Pipe Thread (BSPT)
 FI-WE-...-Rk

64

Metric Taper Thread
 FI-WE-...-Mk

65

NPT Thread
 FI-WE-...-N

66

Male Stud Branch Tee
 FI-TE

68-73

**Whitworth Parallel Pipe Thread (BSPP) /
 Metallic Sealing Edge**
 FI-TE-...-R

68

**Metric Parallel Thread /
 Metallic Sealing Edge**
 FI-TE-...-M

69

Whitworth Taper Pipe Thread (BSPT)
 FI-TE-...-Rk

70

Metric Taper Thread
 FI-TE-...-Mk

71

NPT Thread
 FI-TE-...-N

72

Male Stud Barrel Tee
 FI-LE

74-79

**Whitworth Parallel Pipe Thread (BSPP) /
 Metallic Sealing Edge**
 FI-LE-...-R

74

**Metric Parallel Thread /
 Metallic Sealing Edge**
 FI-LE-...-M

75

Whitworth Taper Pipe Thread (BSPT)
 FI-LE-...-Rk

76

Metric Taper Thread
 FI-LE-...-Mk

77

NPT Thread
 FI-LE-...-N

78

C

Straight Male Stud Fitting
Type FI-GE-...-R • Series L

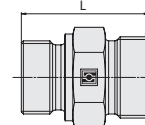
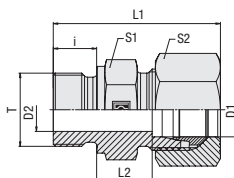

C

Whitworth Parallel Pipe Thread (BSPP)

Metallic Sealing Edge

Ordering Codes

***FI-GE*-10*L*RA*-W3*-MS**

- * Straight Male Stud Fitting **FI-GE**
- * Outside Tube Diameter D1 (in mm) **-10**
- * Series Light Series (pages 38/39) **L**
Heavy Series (pages 40/41) **S**
- * Thread Type Whitworth Parallel Pipe Thread (BSPP) **R**
- If required, please indicate special sizes, e.g. R1/8!
- * Material Code Steel, zinc/nickel-plated **-W3**
- Please contact STAUFF for alternative materials and surface finishings.
- * Assembling / Kitting Fitting body only **—**
Fitting body supplied with cutting ring and union nut **-MS**
Fitting body supplied with soft-sealing cutting ring and union nut **-MSV**

Connecting Parts

- Cutting Ring Type **FI-DS** Page 26
- Soft-Sealing Cutting Ring Type **FI-WDDS** Page 27
- Support Sleeve Type **FI-VH** Page 28
- STAUFF Form Ring Type **FI-AR** Page 30
- Union Nut Type **FI-M** Page 31
- 37° Flared Tube Fitting Set Type **FI-AB** Page 35

Series	Tube OD (mm/in)	PN (bar/psi)	Dimensions (mm/in)										Torque (N-m/ft-lb)	Weight (kg/lbs) ca. per 100 ²	Ordering Codes ³
			Thread	T	D2	i	L	L1 ¹	L2	S1	S2	Thread T			
L	6	400	G 1/8	4	8	23,5	31,5	8,5	14	14	18	1,37	FI-GE-06LR-W3		
	.24	5800		.16	.31	.93	1.24	.33	.55	.55	13.3	3.01			
L	6	400	G 1/4	4	12	29	37	10	19	14	35	2,84	FI-GE-06LR1/4-W3		
	.24	5800		.16	.47	1.14	1.46	.39	.75	.55	25.9	6.24			
L	6	400	G 3/8	4	12	30,5	38,5	11,5	22	14	70	4,13	FI-GE-06LR3/8-W3		
	.24	5800		.16	.47	1.20	1.52	.45	.87	.55	51.8	9.08			
L	6	400	G 1/2	4	14	33	41	12	27	14	110	6,48	FI-GE-06LR1/2-W3		
	.24	5800		.16	.55	1.30	1.61	.47	1.06	.55	81.4	14.26			
L	8	400	G 1/8	4	8	24,5	32,5	9,5	14	17	18	1,61	FI-GE-08LR1/8-W3		
	.31	5800		.16	.31	.96	1.28	.37	.55	.67	13.3	3.54			
L	8	400	G 1/4	6	12	29	37	10	19	17	35	2,72	FI-GE-08LR-W3		
	.31	5800		.24	.47	1.14	1.46	.39	.75	.67	25.9	5.97			
L	8	400	G 3/8	6	12	30,5	38,5	11	22	17	70	4,46	FI-GE-08LR3/8-W3		
	.31	5800		.24	.47	1.20	1.52	.43	.87	.67	51.8	9.81			
L	8	400	G 1/2	6	14	33	41	12	27	17	110	7,51	FI-GE-08LR1/2-W3		
	.31	5800		.24	.55	1.30	1.61	.47	1.06	.67	81.4	16.53			
L	10	400	G 1/8	4	8	25,5	33,5	1,5	17	19	18	2,00	FI-GE-10LR1/8-W3		
	.39	5800		.16	.31	1.00	1.32	.41	.67	.75	13.3	4.40			
L	10	400	G 1/4	6	12	30	38	11	19	19	35	2,95	FI-GE-10LR-W3		
	.39	5800		.24	.47	1.18	1.50	.43	.75	.75	25.9	6.48			
L	10	400	G 3/8	8	12	31,5	39,5	12,5	22	19	70	4,29	FI-GE-10LR3/8-W3		
	.39	5800		.31	.47	1.24	1.56	.49	.87	.75	51.8	9.44			
L	10	400	G 1/2	8	14	34	42	13	27	19	110	7,08	FI-GE-10LR1/2-W3		
	.39	5800		.31	.55	1.34	1.65	.51	1.06	.75	81.4	15.58			
L	10	400	G 3/4	8	16	37,5	45,5	14,5	32	19	180	9,29	FI-GE-10LR3/4-W3		
	.39	5800		.31	.63	1.48	1.79	.57	1.26	.75	133.2	20.43			
L	12	400	G 1/8	4	8	26,5	34,5	11,5	19	22	18	2,49	FI-GE-12LR1/8-W3		
	.47	5800		.16	.31	1.04	1.36	.45	.75	.87	13.3	5.48			
L	12	400	G 1/4	6	12	31	39	12	19	22	35	3,10	FI-GE-12LR1/4-W3		
	.47	5800		.24	.47	1.22	1.54	.47	.75	.87	25.9	6.81			
L	12	400	G 3/8	9	12	31,5	39,5	12,5	22	22	70	4,24	FI-GE-12LR-W3		
	.47	5800		.35	.47	1.24	1.56	.49	.87	.87	51.8	9.32			
L	12	400	G 1/2	10	14	34	42	13	27	22	110	6,67	FI-GE-12LR1/2-W3		
	.47	5800		.39	.55	1.34	1.65	.51	1.06	.87	81.4	14.68			
L	12	400	G 3/4	10	16	37	45	14	32	22	180	10,83	FI-GE-12LR3/4-W3		
	.47	5800		.39	.63	1.46	1.77	.55	1.26	.87	133.2	23.83			
L	15	400	G 1/4	6	12	33	41	14	24	27	35	4,93	FI-GE-15LR1/4-W3		
	.59	5800		.24	.47	1.30	1.61	.55	.94	1.06	25.9	10.85			
L	15	400	G 3/8	9	12	32,5	4,5	13	24	27	70	5,03	FI-GE-15LR3/8-W3		
	.59	5800		.35	.47	1.28	1.59	.51	.94	1.06	51.8	11.06			
L	15	400	G 1/2	11	14	35	43	14	27	27	110	6,53	FI-GE-15LR-W3		
	.59	5800		.43	.55	1.38	1.69	.55	1.06	1.06	81.4	14.37			
L	15	400	G 3/4	12	16	38	46	15	32	27	180	10,06	FI-GE-15LR3/4-W3		
	.59	5800		.47	.63	1.50	1.81	.59	1.26	1.06	133.2	22.14			

¹ Approximate dimension in assembled condition.

² Weight excluding cutting ring and union nut.

³ Standard scope of delivery: Fitting body only.

Male stud acc. to DIN 3852-2 (Form B) / ISO 1179-4 (Type B)
Port acc. to DIN 3852-2 (Form X) / ISO 1179-1

Torque recommendations for Steel mating material.

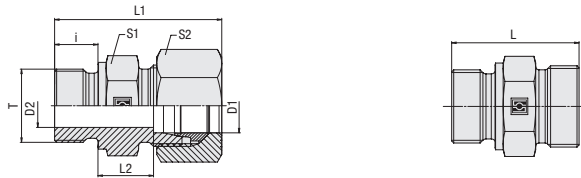

**Straight Male Stud Fitting
Type FI-GE-...-R • Series L**

C
Metallic Sealing Edge
Whitworth Parallel Pipe Thread (BSPP)

Series	Tube OD (mm/in)	PN (bar/PSI)	Dimensions (mm/in)								Torque (N-m/ft-lb)	Weight (kg/lbs) ca. per 100 ²	Ordering Codes ³
			Thread T	D2	i	L	L1 ¹	L2	S1	S2			
L	18	400	G 3/8	9	12	33,5	42,5	14	27	32	70	6,41	FI-GE-18LR3/8-W3
	.71	5800		.35	.47	1.32	1.67	.55	1.06	1.26	51.8	14.11	
	18	400	G 1/2	14	14	36	45	14,5	27	32	110	7,13	FI-GE-18LR-W3
	.71	5800		.55	.55	1.42	1.77	.57	1.06	1.26	81.4	15.69	
	18	400	G 3/4	15	16	38	47	14,5	32	32	180	11,28	FI-GE-18LR3/4-W3
	.71	5800		.59	.63	1.50	1.85	.57	1.26	1.26	133.2	24.82	
	18	400	G 1	15	18	40	49	14,5	41	32	330	15,87	FI-GE-18LR1-W3
	.71	5800		.59	.71	1.57	1.93	.57	1.61	1.26	244.2	34.91	
	22	250	G 1/2	14	14	38	47	16,5	32	36	110	8,57	FI-GE-22LR1/2-W3
	.87	3625		.55	.55	1.50	1.85	.65	1.26	1.42	81.4	18.85	
	22	250	G 3/4	18	16	40	49	16,5	32	36	180	10,48	FI-GE-22LR-W3
	.87	3625		.71	.63	1.57	1.93	.65	1.26	1.42	133.2	23.06	
	22	250	G 1	19	18	43	52	17,5	41	36	330	19,17	FI-GE-22LR1-W3
	.87	3625		.75	.71	1.69	2.05	.69	1.61	1.42	244.2	42.17	
	28	250	G 1/2	14	14	39	48	17,5	41	41	110	6,11	FI-GE-28LR1/2-W3
	1.10	3625		.55	.55	1.54	1.89	.69	1.61	1.61	81.4	13.43	
	28	250	G 3/4	18	16	41	50	17,5	41	41	180	14,42	FI-GE-28LR3/4-W3
	1.10	3625		.71	.63	1.61	1.97	.69	1.61	1.61	133.2	31.72	
	28	250	G 1	23	18	43	52	17,5	41	41	330	17,08	FI-GE-28LR-W3
	1.10	3625		.91	.71	1.69	2.05	.69	1.61	1.61	244.2	37.58	
	28	250	G 1 1/4	24	20	46	55	18,5	50	41	540	13,40	FI-GE-28LR1-1/4-W3
	1.10	3625		.94	.79	1.81	2.17	.73	1.97	1.61	399.6	29.48	
	35	250	G 1	23	18	46	57	17,5	46	50	330	22,45	FI-GE-35LR1-W3
	1.38	3625		.91	.71	1.81	2.24	.69	1.81	1.97	244.2	49.38	
	35	250	G 1 1/4	30	20	48	59	17,5	50	50	540	27,69	FI-GE-35LR-W3
	1.38	3625		1.18	.79	1.89	2.32	.69	1.97	1.97	399.6	60.92	
	35	250	G 1 1/2	30	22	52	63	19,5	55	50	630	42,63	FI-GE-35LR1-1/2-W3
	1.38	3625		1.18	.87	2.05	2.48	.77	2.17	1.97	466.2	93.78	
	42	250	G 1	23	18	48	60	19	55	60	330	32,20	FI-GE-42LR1-W3
	1.65	3625		.91	.71	1.89	2.36	.75	2.17	2.36	244.2	70.84	
	42	250	G 1 1/4	30	20	50	62	19	55	60	540	34,71	FI-GE-42LR1-1/4-W3
	1.65	3625		1.18	.79	1.97	2.44	.75	2.17	2.36	399.6	76.35	
	42	250	G 1 1/2	36	22	52	64	19	55	60	630	34,78	FI-GE-42LR-W3
	1.65	3625		1.42	.87	2.05	2.52	.75	2.17	2.36	466.2	76.52	

¹ Approximate dimension in assembled condition.

² Weight excluding cutting ring and union nut.

³ Standard scope of delivery: Fitting body only.

 Male stud acc. to DIN 3852-2 (Form B) / ISO 1179-4 (Type B)
 Port acc. to DIN 3852-2 (Form X) / ISO 1179-1

Torque recommendations for Steel mating material.

Ordering Codes
***FI-GE*-10*L*R*-W3*-MS**

- * Straight Male Stud Fitting FI-GE
- * Outside Tube Diameter D1 (in mm) -10
- * Series L
Light Series (pages 38/39)
Heavy Series (pages 40/41) S
- * Thread Type R
Whitworth Parallel
Pipe Thread (BSPP)
- If required, please indicate special sizes, e.g. R1/8!
- * Material Code -W3
Steel, zinc/nickel-plated
- Please contact STAUFF for alternative materials and surface finishings.
- * Assembling / Kitting —
Fitting body only
- Fitting body supplied with cutting ring and union nut -MS
- Fitting body supplied with soft-sealing cutting ring and union nut -MSV

Connecting Parts

-  Cutting Ring
Type **FI-DS** Page 26
-  Soft-Sealing Cutting Ring
Type **FI-WDDS** Page 27
-  Support Sleeve
Type **FI-VH** Page 28
-  STAUFF Form Ring
Type **FI-AR** Page 30
-  Union Nut
Type **FI-M** Page 31
-  37° Flared Tube Fitting Set
Type **FI-AB** Page 35



Straight Male Stud Fitting
Type FI-GE-...-R • Series S

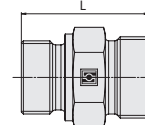
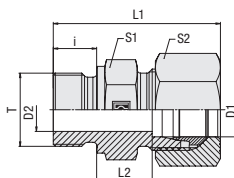

C

Whitworth Parallel Pipe Thread (BSPP)

Metallic Sealing Edge

Ordering Codes

***FI-GE*-10*L*RA*-W3*-MS**

- * Straight Male Stud Fitting **FI-GE**
- * Outside Tube Diameter D1 (in mm) **-10**
- * Series Light Series (pages 38/39) **L**
Heavy Series (pages 40/41) **S**
- * Thread Type Whitworth Parallel Pipe Thread (BSPP) **R**
- If required, please indicate special sizes, e.g. R1/8!
- * Material Code Steel, zinc/nickel-plated **-W3**
- Please contact STAUFF for alternative materials and surface finishings.
- * Assembling / Kitting Fitting body only **—**
Fitting body supplied with cutting ring and union nut **-MS**
Fitting body supplied with soft-sealing cutting ring and union nut **-MSV**

Connecting Parts

- Cutting Ring Type **FI-DS** Page 26
- Soft-Sealing Cutting Ring Type **FI-WDDS** Page 27
- Support Sleeve Type **FI-VH** Page 28
- STAUFF Form Ring Type **FI-AR** Page 30
- Union Nut Type **FI-M** Page 31
- 37° Flared Tube Fitting Set Type **FI-AB** Page 35

Series	Tube OD (mm/in)	PN (bar/psi)	Dimensions (mm/in)										Torque (N·m/ft·lb)	Weight (kg/lbs) ca. per 100 ²	Ordering Codes ³
			D1	Thread T	D2	i	L	L1 ¹	L2	S1	S2	Thread T			
S	6	630	G 1/4	4	12	32	40	13	19	17	55	3,49	FI-GE-06SR-W3		
	.24	9135		.16	.47	1.26	1.57	.51	.75	.67	40.7	7.77			
6	6	630	G 3/8	4	12	34,5	42,5	15,5	22	17	90	2,29	FI-GE-06SR3/8-W3		
	.24	9135		.16	.47	1.36	1.67	.61	.87	.67	66.6	5.03			
6	6	630	G 1/2	4	14	39	47	18	27	17	130	9,40	FI-GE-06SR1/2-W3		
	.24	9135		.16	.55	1.54	1.85	.71	1.06	.67	96.2	20.68			
8	8	630	G 1/4	5	12	34	42	15	19	19	55	4,06	FI-GE-08SR-W3		
	.31	9135		.20	.47	1.34	1.65	.59	.75	.75	40.7	8.93			
8	8	630	G 3/8	5	12	34,5	42,5	15,5	22	19	90	5,77	FI-GE-08SR3/8-W3		
	.31	9135		.20	.47	1.36	1.67	.61	.87	.75	66.6	12.69			
8	8	630	G 1/2	5	14	39	47	18	27	19	130	9,91	FI-GE-08SR1/2-W3		
	.31	9135		.20	.55	1.54	1.85	.71	1.06	.75	96.2	21.80			
10	10	630	G 1/4	5	12	34	43	14,5	19	22	55	4,35	FI-GE-10SR1/4-W3		
	.39	9135		.20	.47	1.34	1.69	.57	.75	.87	40.7	9.57			
10	10	630	G 3/8	7	12	34,5	43,5	15	22	22	90	5,68	FI-GE-10SR-W3		
	.39	9135		.28	.47	1.36	1.71	.59	.87	.87	66.6	12.50			
10	10	630	G 1/2	7	14	39	48	17,5	27	22	130	9,73	FI-GE-10SR1/2-W3		
	.39	9135		.28	.55	1.54	1.89	.69	1.06	.87	96.2	21.41			
12	12	630	G 1/4	5	12	36	45	16,5	22	24	55	5,93	FI-GE-12SR1/4-W3		
	.47	9135		.20	.47	1.42	1.77	.65	.87	.94	40.7	13.05			
12	12	630	G 3/8	8	12	36,5	45,5	17	22	24	90	5,02	FI-GE-12SR-W3		
	.47	9135		.31	.47	1.44	1.79	.67	.87	.94	66.6	11.04			
12	12	630	G 1/2	8	14	39	48	17,5	27	24	130	9,72	FI-GE-12SR1/2-W3		
	.47	9135		.31	.55	1.54	1.89	.69	1.06	.94	96.2	21.38			
12	12	630	G 3/4	8	16	43	52	19,5	32	24	270	16,48	FI-GE-12SR3/4-W3		
	.47	9135		.31	.63	1.69	2.05	.77	1.26	.94	199.8	36.26			
14	14	630	G 1/4	5	12	36	46	16	22	27	55	6,72	FI-GE-14SR1/4-W3		
	.55	9135		.20	.47	1.42	1.81	.63	.87	1.06	40.7	14.78			
14	14	630	G 3/8	8	12	38,5	48,5	18,5	22	27	90	6,95	FI-GE-14SR3/8-W3		
	.55	9135		.31	.47	1.52	1.91	.73	.87	1.06	66.6	15.29			
14	14	630	G 1/2	10	14	41	51	19	27	27	130	9,79	FI-GE-14SR-W3		
	.55	9135		.39	.55	1.61	2.01	.75	1.06	1.06	96.2	21.54			
14	14	630	G 3/4	10	16	45	55	21	32	27	270	16,30	FI-GE-14SR3/4-W3		
	.55	9135		.39	.63	1.77	2.17	.83	1.26	1.06	199.8	35.86			
16	16	630	G 3/8	8	12	38,5	48,5	18	27	30	90	6,42	FI-GE-16SR3/8-W3		
	.63	9135		.31	.47	1.52	1.91	.71	1.06	1.18	66.6	14.12			
16	16	630	G 1/2	12	14	41	51	18,5	27	30	130	9,15	FI-GE-16SR-W3		
	.63	9135		.47	.55	1.61	2.01	.73	1.06	1.18	96.2	21.13			
16	16	400	G 3/4	12	16	45	55	20,5	32	30	270	15,75	FI-GE-16SR3/4-W3		
	.63	5800		.47	.63	1.77	2.17	.81	1.26	1.18	199.8	34.65			

¹ Approximate dimension in assembled condition.

² Weight excluding cutting ring and union nut.

³ Standard scope of delivery: Fitting body only.

Male stud acc. to DIN 3852-2 (Form B) / ISO 1179-4 (Type B)
Port acc. to DIN 3852-2 (Form X) / ISO 1179-1

Torque recommendations for Steel mating material.



**Straight Male Stud Fitting
Type FI-GE-...-R • Series S**

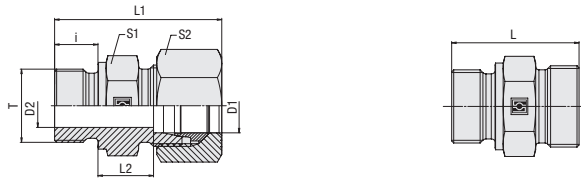

C

Metallic Sealing Edge

Whitworth Parallel Pipe Thread (BSPP)

Series	Tube OD (mm/in)	PN (bar/PSI)	Dimensions (mm/in)										Torque (N-m/ft-lb)	Weight (kg/lbs) ca. per 100 ²	Ordering Codes ³
			Thread	T	D2	i	L	L1 ¹	L2	S1	S2	Thread			
S	20	400	G 1/2	12	14	45	56	20.5	32	36	130	13.69	FI-GE-20SR1/2-W3		
	.79	5800		.47	.55	1.77	2.20	.81	1.26	1.42	96.2	30.11			
	20	400	G 3/4	16	16	47	58	20.5	32	36	270	15.24	FI-GE-20SR-W3		
	.79	5800		.63	.63	1.85	2.28	.81	1.26	1.42	199.8	33.54			
	20	400	G 1	16	18	51	62	22.5	41	36	340	25.90	FI-GE-20SR1-W3		
	.79	5800		.63	.71	2.01	2.44	.89	1.61	1.42	251.6	56.98			
	25	400	G 3/4	16	16	51	63	23	41	46	270	24.73	FI-GE-25SR3/4-W3		
	.98	5800		.63	.63	2.01	2.48	.91	1.61	1.81	199.8	54.40			
	25	400	G 1	20	18	53	65	23	41	46	340	26.89	FI-GE-25SR-W3		
	.98	5800		.79	.71	2.09	2.56	.91	1.61	1.81	251.6	59.16			
	25	250	G 1 1/4	20	20	55	67	23	50	46	540	23.28	FI-GE-25SR1-1/4-W3		
	.98	3625		.79	.79	2.17	2.64	.91	1.97	1.81	399.6	51.22			
	30	250	G 1	20	18	55	68	23.5	46	50	340	33.52	FI-GE-30SR1-W3		
	1.18	3625		.79	.71	2.17	2.68	.93	1.81	1.97	251.6	73.75			
	30	250	G 1 1/4	25	20	57	70	23.5	50	50	540	42.11	FI-GE-30SR-W3		
	1.18	3625		.98	.79	2.24	2.76	.93	1.97	1.97	399.6	92.65			
	30	250	G 1 1/2	25	22	59	72	23.5	55	50	700	57.10	FI-GE-30SR1-1/2-W3		
	1.18	3625		.98	.87	2.32	2.83	.93	2.17	1.97	518.0	125.63			
	38	250	G 1	20	18	62	77	28	55	60	340	52.40	FI-GE-38SR1-W3		
	1.50	3625		.79	.71	2.44	3.03	1.10	2.17	2.36	251.6	115.28			
	38	250	G 1 1/4	25	20	62	75	26	55	60	540	57.22	FI-GE-38SR1-1/4-W3		
	1.50	3625		.98	.79	2.44	2.95	1.02	2.17	2.36	399.6	125.88			
	38	250	G 1 1/2	32	22	64	77	26	55	60	700	56.30	FI-GE-38SR-W3		
	1.50	3625		1.26	.87	2.52	3.03	1.02	2.17	2.36	518.0	123.86			

Ordering Codes

***FI-GE*-10*L*R*-W3*-MS**

- * Straight Male Stud Fitting FI-GE
- * Outside Tube Diameter D1 (in mm) -10
- * Series L
Light Series (pages 38/39)
S
Heavy Series (pages 40/41)
- * Thread Type R
Whitworth Parallel
Pipe Thread (BSPP)
- If required, please indicate special sizes, e.g. R1/8!
- * Material Code -W3
Steel, zinc/nickel-plated
- Please contact STAUFF for alternative materials and surface finishings.
- * Assembling / Kitting —
Fitting body only
- Fitting body supplied with cutting ring and union nut -MS
- Fitting body supplied with soft-sealing cutting ring and union nut -MSV

¹ Approximate dimension in assembled condition.

² Weight excluding cutting ring and union nut.

³ Standard scope of delivery: Fitting body only.

Male stud acc. to DIN 3852-2 (Form B) / ISO 1179-4 (Type B)
Port acc. to DIN 3852-2 (Form X) / ISO 1179-1

Torque recommendations for Steel mating material.

Connecting Parts

-  Cutting Ring
Type **FI-DS** Page 26
-  Soft-Sealing Cutting Ring
Type **FI-WDDS** Page 27
-  Support Sleeve
Type **FI-VH** Page 28
-  STAUFF Form Ring
Type **FI-AR** Page 30
-  Union Nut
Type **FI-M** Page 31
-  37° Flared Tube Fitting Set
Type **FI-AB** Page 35



Straight Male Stud Fitting
Type FI-GE-...-M • Series L

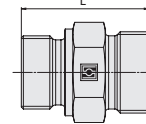
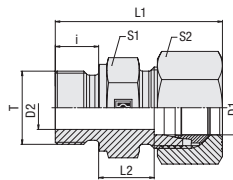

C

Metric Parallel Thread

Metallic Sealing Edge

Ordering Codes

***FI-GE*-10*L*M*-W3*-MS**

- * Straight Male Stud Fitting **FI-GE**
- * Outside Tube Diameter D1 (in mm) **-10**
- * Series Light Series (page 42) **L**
Heavy Series (page 43) **S**
- * Thread Type Metric Parallel Thread **M**
- If required, please indicate special sizes, e.g. M12x1.5!
- * Material Code Steel, zinc/nickel-plated **-W3**
- Please contact STAUFF for alternative materials and surface finishings.
- * Assembling / Kitting Fitting body only **—**
Fitting body supplied with cutting ring and union nut **-MS**
Fitting body supplied with soft-sealing cutting ring and union nut **-MSV**

Connecting Parts

- Cutting Ring Type **FI-DS** Page 26
- Soft-Sealing Cutting Ring Type **FI-WDDS** Page 27
- Support Sleeve Type **FI-VH** Page 28
- STAUFF Form Ring Type **FI-AR** Page 30
- Union Nut Type **FI-M** Page 31
- 37° Flared Tube Fitting Set Type **FI-AB** Page 35

¹ Approximate dimension in assembled condition.

² Weight excluding cutting ring and union nut.

³ Standard scope of delivery: Fitting body only.

Male stud acc. to DIN 3852-1 (Form B) / ISO 9974-3 (Type B)

Port acc. to DIN 3852-1 (Form X) / ISO 9974-1

Torque recommendations for Steel mating material.

Series	Tube OD (mm/in)	PN (bar/psi)	Dimensions (mm/in)										Torque (N·m/ft-lb)	Weight (kg/lbs) ca. per 100 ²	Ordering Codes ³
			D1	Thread T	D2	i	L	L1 ¹	L2	S1	S2	Thread T			
L	6	400	M 10 x 1	4	8	23,5	31,5	8,5	14	14	18	1,38	FI-GE-06LM-W3		
	.24	5800		.16	.31	.93	1.24	.33	.55	.55	13.3	3.03			
	6	400	M 12 x 1,5	4	12	29	37	10	17	14	30	2,26	FI-GE-06LM12x1.5-W3		
	.24	5800		.16	.47	1.14	1.46	.39	.67	.55	22.2	4.98			
	6	400	M 14 x 1,5	4	12	30	38	11	19	14	45	2,89	FI-GE-06LM14x1.5-W3		
	.24	5800		.16	.47	1.18	1.50	.43	.75	.55	33.3	6.35			
	8	400	M 10 x 1	4	8	23,5	31,5	8,5	14	17	18	1,53	FI-GE-08LM10x1-W3		
	.31	5800		.16	.31	.93	1.24	.33	.55	.67	13.3	3.37			
	8	400	M 12 x 1,5	6	12	29	37	10	17	17	30	2,21	FI-GE-08LM-W3		
	.31	5800		.24	.47	1.14	1.46	.39	.67	.67	22.2	4.86			
	8	400	M 14 x 1,5	6	12	30	38	11	19	17	45	3,11	FI-GE-08LM14x1.5-W3		
	.31	5800		.24	.47	1.18	1.50	.43	.75	.67	33.3	6.83			
	8	400	M 16 x 1,5	6	12	30	38	11	22	17	65	4,05	FI-GE-08LM16x1.5-W3		
	.31	5800		.24	.47	1.18	1.50	.43	.87	.67	48.1	8.91			
	8	400	M 18 x 1,5	6	12	30,5	38,5	11,5	24	17	80	4,34	FI-GE-08LM18x1.5-W3		
	.31	5800		.24	.47	1.20	1.52	.45	.94	.67	59.2	9.54			
	10	400	M 10 x 1	4	8	25,5	33,5	1,5	17	19	18	2,20	FI-GE-10LM10x1-W3		
	.39	5800		.16	.31	1.00	1.32	.41	.67	.75	13.3	4.84			
	10	400	M 12 x 1,5	6	12	30	38	11	17	19	30	2,38	FI-GE-10LM12x1.5-W3		
	.39	5800		.24	.47	1.18	1.50	.43	.67	.75	22.2	5.23			
	10	400	M 14 x 1,5	7	12	30	38	11	19	19	45	2,94	FI-GE-10LM-W3		
	.39	5800		.28	.47	1.18	1.50	.43	.75	.75	33.3	6.46			
	10	400	M 16 x 1,5	8	12	31,5	39,5	12,5	22	19	65	4,05	FI-GE-10LM16x1.5-W3		
	.39	5800		.31	.47	1.24	1.56	.49	.87	.75	48.1	8.91			
	10	400	M 18 x 1,5	8	12	31,5	39,5	12,5	24	19	80	4,94	FI-GE-10LM18x1.5-W3		
	.39	5800		.31	.47	1.24	1.56	.49	.94	.75	59.2	10.86			
	10	400	M 22 x 1,5	8	14	34	42	13	27	19	140	7,36	FI-GE-10LM22x1.5-W3		
	.39	5800		.31	.55	1.34	1.65	.51	1.06	.75	103.6	16.19			
	12	400	M 12 x 1,5	6	12	30	38	11	19	22	30	2,84	FI-GE-12LM12x1.5-W3		
	.47	5800		.24	.47	1.18	1.50	.43	.75	.87	22.2	6.25			
	12	400	M 14 x 1,5	7	12	30	38	11	19	22	45	3,06	FI-GE-12LM14x1.5-W3		
	.47	5800		.28	.47	1.18	1.50	.43	.75	.87	33.3	6.72			
	12	400	M 16 x 1,5	9	12	31,5	39,5	12,5	22	22	65	3,92	FI-GE-12LM-W3		
	.47	5800		.35	.47	1.24	1.56	.49	.87	.87	48.1	8.63			
	12	400	M 18 x 1,5	10	12	31,5	39,5	12,5	24	22	80	4,90	FI-GE-12LM18x1.5-W3		
	.47	5800		.39	.47	1.24	1.56	.49	.94	.87	59.2	10.78			
	12	400	M 22 x 1,5	10	14	35	43	14	27	22	140	6,96	FI-GE-12LM22x1.5-W3		
	.47	5800		.39	.55	1.38	1.69	.55	1.06	.87	103.6	15.31			
	15	400	M 16 x 1,5	9	12	32	40	13	24	27	65	5,15	FI-GE-15LM16x1.5-W3		
	.59	5800		.35	.47	1.26	1.57	.51	.94	1.06	48.1	11.33			
	15	400	M 18 x 1,5	11	12	32,5	4,5	13,5	24	27	80	5,28	FI-GE-15LM-W3		
	.59	5800		.43	.47	1.28	1.59	.53	.94	1.06	59.2	11.61			
	15	400	M 22 x 1,5	12	14	35	43	14	27	27	140	7,15	FI-GE-15LM22x1.5-W3		
	.59	5800		.47	.55	1.38	1.69	.55	1.06	1.06	103.6	15.73			
	18	400	M 18 x 1,5	11	12	33,5	42,5	14	27	32	80	6,26	FI-GE-18LM18x1.5-W3		
	.71	5800		.43	.47	1.32	1.67	.55	1.06	1.26	59.2	13.77			
	18	400	M 22 x 1,5	14	14	36	45	14,5	27	32	140	7,60	FI-GE-18LM-W3		
	.71	5800		.55	.55	1.42	1.77	.57	1.06	1.26	103.6	16.72			
18	250	M 26 x 1,5	15	16	38	47	14,5	32	32	190	10,88	FI-GE-18LM26x1.5-W3			
.71	3625		.59	.63	1.50	1.85	.57	1.26	1.26	140.6	23.94				
22	250	M 22 x 1,5	14	14	38	47	16,5	32	36	140	9,10	FI-GE-22LM22x1.5-W3			
.87	3625		.55	.55	1.50	1.85	.65	1.26	1.42	103.6	20.02				
22	250	M 26 x 1,5	18	16	40	49	16,5	32	36	190	10,34	FI-GE-22LM-W3			
.87	3625		.71	.63	1.57	1.93	.65	1.26	1.42	140.6	22.74				
28	250	M 33 x 2	23	18	43	52	17,5	41	41	340	17,13	FI-GE-28LM-W3			
1.10	3625		.91	.71	1.69	2.05	.69	1.61	1.61	251.6	37.69				
35	250	M 42 x 2	30	20	48	59	17,5	50	50	500	27,85	FI-GE-35LM-W3			
1.38	3625		1.18	.79	1.89	2.32	.69	1.97	1.97	370.0	61.27				
42	250	M 48 x 2	36	22	52	64	19	55	60	630	35,91	FI-GE-42LM-W3			
1,65	3625		1.42	.87	2.05	2.52	.75	2.17	2.36	466.2	79.00				



**Straight Male Stud Fitting
Type FI-GE-...-M ▪ Series S**

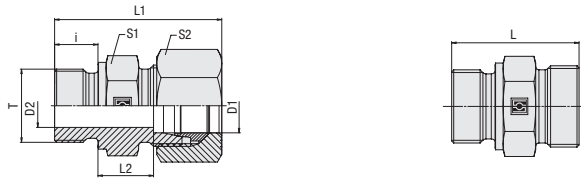

C

Metallic Sealing Edge

Metric Parallel Thread

Series	Tube OD		PN (bar/PSI)	Dimensions (mm/in)								Torque (N·m/ft·lb)	Weight (kg/lbs) ca. per 100 ²	Ordering Codes ³
	D1	D2		Thread	T	D2	i	L	L1 ¹	L2	S1			
S	6	630	9135	M 12 x 1,5	4	12	32	40	13	17	17	35	2,99	FI-GE-06SM-W3
	.24	.47			1.26	1.57	.51	.67	.67	25.9	6.58			
8	630	9135	M 14 x 1,5	5	12	34	42	15	19	19	55	4,26	FI-GE-08SM-W3	
	.31			.47	1.34	1.65	.59	.75	.75	40.7	9.37			
10	630	9135	M 16 x 1,5	7	12	34,5	43,5	15	22	22	70	5,46	FI-GE-10SM-W3	
	.39			.47	1.36	1.71	.59	.87	.87	51.8	12.01			
10	630	9135	M 18 x 1,5	7	12	36,5	45,5	17	24	22	110	7,66	FI-GE-10SM18x1.5-W3	
	.39			.47	1.44	1.79	.67	.94	.87	81.4	16.85			
12	630	9135	M 14 x 1,5	5	12	36	45	17	22	24	55	6,00	FI-GE-12SM14x1.5-W3	
	.47			.47	1.42	1.77	.67	.87	.94	40.7	13.20			
12	630	9135	M 16 x 1,5	7	12	24,5	48	17	22	24	70	6,12	FI-GE-12SM16x1.5-W3	
	.47			.47	.96	1.89	.67	.87	.94	51.8	13.47			
12	630	9135	M 18 x 1,5	8	12	36,5	45,5	17	24	24	110	7,19	FI-GE-12SM-W3	
	.47			.47	1.44	1.79	.67	.94	.94	81.4	15.83			
12	630	9135	M 22 x 1,5	8	14	39	48	17,5	27	24	170	9,28	FI-GE-12SM22x1.5-W3	
	.47			.55	1.54	1.89	.69	1.06	.94	125.8	20.42			
14	630	9135	M 20 x 1,5	10	14	41	51	19	27	27	150	9,49	FI-GE-14SM-W3	
	.55			.55	1.61	2.01	.75	1.06	1.06	111.0	20.88			
16	630	9135	M 18 x 1,5	8	12	38,5	48,5	18	27	30	110	7,82	FI-GE-16SM18x1.5-W3	
	.63			.47	1.52	1.91	.71	1.06	1.18	81.4	17.20			
16	630	9135	M 22 x 1,5	12	14	41	51	18,5	27	30	170	9,75	FI-GE-16SM-W3	
	.63			.55	1.61	2.01	.73	1.06	1.18	125.8	21.44			
20	400	5800	M 22 x 1,5	12	14	47	58	22,5	32	36	170	13,95	FI-GE-20SM22x1.5-W3	
	.79			.55	1.85	2.28	.89	1.26	1.42	125.8	30.69			
20	400	5800	M 27 x 2	16	16	47	58	20,5	32	36	270	15,12	FI-GE-20SM-W3	
	.79			.63	1.85	2.28	.81	1.26	1.42	199.8	33.22			
25	400	5800	M 33 x 2	20	18	53	65	23	41	46	410	26,71	FI-GE-25SM-W3	
	.98			.71	2.09	2.56	.91	1.61	1.81	303.4	58.77			
30	250	3625	M 42 x 2	25	20	57	70	23,5	50	50	540	42,96	FI-GE-30SM-W3	
	1.18			.79	2.24	2.76	.93	1.97	1.97	399.6	94.51			
38	250	3625	M 48 x 2	32	22	64	79	26	55	60	700	56,40	FI-GE-38SM-W3	
	1.50			.87	2.52	3.11	1.02	2.17	2.36	518.0	124.08			

¹ Approximate dimension in assembled condition.

² Weight excluding cutting ring and union nut.

³ Standard scope of delivery: Fitting body only.

Male stud acc. to DIN 3852-1 (Form B) / ISO 9974-3 (Type B)
Port acc. to DIN 3852-1 (Form X) / ISO 9974-1

Torque recommendations for Steel mating material.

Ordering Codes

***FI-GE*-10*L*M*-W3*-MS**

- * Straight Male Stud Fitting FI-GE
- * Outside Tube Diameter D1 (in mm) -10
- * Series L
Light Series (page 42)
Heavy Series (page 43) S
- * Thread Type M
Metric Parallel Thread
- If required, please indicate special sizes, e.g. M12x1.5!
- * Material Code -W3
Steel, zinc/nickel-plated
- Please contact STAUFF for alternative materials and surface finishings.
- * Assembling / Kitting —
Fitting body only
- Fitting body supplied with cutting ring and union nut -MS
- Fitting body supplied with soft-sealing cutting ring and union nut -MSV

Connecting Parts

-  Cutting Ring
Type **FI-DS** Page 26
-  Soft-Sealing Cutting Ring
Type **FI-WDDS** Page 27
-  Support Sleeve
Type **FI-VH** Page 28
-  STAUFF Form Ring
Type **FI-AR** Page 30
-  Union Nut
Type **FI-M** Page 31
-  37° Flared Tube Fitting Set
Type **FI-AB** Page 35



Straight Male Stud Fitting
Type FI-GE-...-R-WD ■ Series L

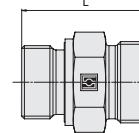
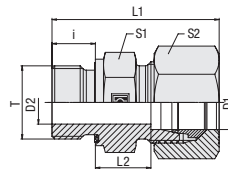

C

Whitworth Parallel Pipe Thread (BSPP)

Profile Sealing Ring

Ordering Codes

***FI-GE*-10*L*R*-WD*-B*-W3*-MS**

- * Straight Male Stud Fitting **FI-GE**
- * Outside Tube Diameter D1 (in mm) **-10**
- * Series **L**
Light Series (pages 44/45)
S
Heavy Series (pages 46/47)
- * Thread Type **R**
Whitworth Parallel
Pipe Thread (BSPP)
- If required, please indicate special sizes, e.g. R1/8!
- * Seal Type **-WD**
Profile Sealing Ring
- * Seal Material **-B**
NBR (Buna-N®)
-V
FKM (Viton®)
-E
EPDM
- * Material Code **-W3**
Steel, zinc/nickel-plated
- Please contact STAUFF for alternative materials and surface finishings.
- * Assembling / Kitting **—**
Fitting body only
- Fitting body supplied with cutting ring and union nut **-MS**
- Fitting body supplied with soft-sealing cutting ring and union nut **-MSV**

Connecting Parts

-  Cutting Ring
Type **FI-DS** Page 26
-  Soft-Sealing Cutting Ring
Type **FI-WDDS** Page 27
-  Support Sleeve
Type **FI-VH** Page 28
-  STAUFF Form Ring
Type **FI-AR** Page 30
-  Union Nut
Type **FI-M** Page 31
-  37° Flared Tube Fitting Set
Type **FI-AB** Page 35

Spare Parts / Accessories

-  Profile Sealing Ring
Type **WDG** Page 206

Series	Tube OD (mm/in)	PN (bar/psi)	Dimensions (mm/in)										Torque (N-m/lb-ft)	Weight (kg/lbs) ca.	Ordering Codes ³
			Thread	T	D2	i	L	L1 ¹	L2	S1	S2	Thread T			
L	6	500	G 1/8	4	8	23,5	31,5	8,5	14	14	18	1,33	FI-GE-06LR-WD-B-W3		
	.24	7250		.16	.31	.93	1.24	.33	.55	.55	13.3	2.93			
	6	500	G 1/4	4	12	29	37	10	19	14	35	2,74	FI-GE-06LR1/4-WD-B-W3		
	.24	7250		.16	.47	1.14	1.46	.39	.75	.55	25.9	6.04			
	6	400	G 3/8	4	12	30,5	38,5	11,5	22	14	70	4,03	FI-GE-06LR3/8-WD-B-W3		
	.24	5800		.16	.47	1.20	1.52	.45	.87	.55	51.8	8.87			
	6	400	G 1/2	4	14	33	41	12	27	14	90	6,37	FI-GE-06LR1/2-WD-B-W3		
	.24	5800		.16	.55	1.30	1.61	.47	1.06	.55	66.6	14.01			
	8	500	G 1/8	4	8	24,5	32,5	9,5	14	17	18	1,61	FI-GE-08LR1/8-WD-B-W3		
	.31	7250		.16	.31	.96	1.28	.37	.55	.67	13.3	3.53			
	8	500	G 1/4	6	12	29	37	10	19	17	35	2,65	FI-GE-08LR-WD-B-W3		
	.31	7250		.24	.47	1.14	1.46	.39	.75	.67	25.9	5.83			
	8	400	G 3/8	6	12	30,5	38,5	11,5	22	17	70	4,35	FI-GE-08LR3/8-WD-B-W3		
	.31	5800		.24	.47	1.20	1.52	.45	.87	.67	51.8	9.57			
	8	400	G 1/2	6	14	33	41	12	27	17	90	6,58	FI-GE-08LR1/2-WD-B-W3		
	.31	5800		.24	.55	1.30	1.61	.47	1.06	.67	66.6	14.48			
	10	500	G 1/8	4	8	25,5	33,5	10,5	17	19	18	2,05	FI-GE-10LR1/8-WD-B-W3		
	.39	7250		.16	.31	1.00	1.32	.41	.67	.75	13.3	4.52			
	10	500	G 1/4	6	12	30	38	11	19	19	35	2,88	FI-GE-10LR-WD-B-W3		
	.39	7250		.24	.47	1.18	1.50	.43	.75	.75	25.9	6.34			
	10	400	G 3/8	8	12	31,5	39,5	12,5	22	19	70	4,15	FI-GE-10LR3/8-WD-B-W3		
	.39	5800		.31	.47	1.24	1.56	.49	.87	.75	51.8	9.12			
	10	400	G 1/2	8	14	34	42	13	27	19	90	7,10	FI-GE-10LR1/2-WD-B-W3		
	.39	5800		.31	.55	1.34	1.65	.51	1.06	.75	66.6	15.61			
	12	400	G 1/8	4	8	26,5	34,5	11,5	19	22	18	2,55	FI-GE-12LR1/8-WD-B-W3		
	.47	5800		.16	.31	1.04	1.36	.45	.75	.87	13.3	5.61			
	12	400	G 1/4	6	12	31	39	12	19	22	35	3,05	FI-GE-12LR1/4-WD-B-W3		
	.47	5800		.24	.47	1.22	1.54	.47	.75	.87	25.9	6.70			
12	400	G 3/8	9	12	31,5	39,5	12,5	22	22	70	4,14	FI-GE-12LR-WD-B-W3			
.47	5800		.35	.47	1.24	1.56	.49	.87	.87	51.8	9.10				
12	400	G 1/2	10	14	34	42	13	27	22	90	6,65	FI-GE-12LR1/2-WD-B-W3			
.47	5800		.39	.55	1.34	1.65	.51	1.06	.87	66.6	14.63				
12	250	G 3/4	10	16	37	45	14	32	22	180	9,25	FI-GE-12LR3/4-WD-B-W3			
.47	3625		.39	.63	1.46	1.77	.55	1.26	.87	133.2	20.34				
15	400	G 1/4	7	12	31,5	39,5	12,5	22	27	35	4,07	FI-GE-15LR1/4-WD-B-W3			
.59	5800		.28	.47	1.24	1.56	.49	.87	1.06	25.9	8.95				
15	400	G 3/8	9	12	32,5	40,5	13,5	24	27	70	5,32	FI-GE-15LR3/8-WD-B-W3			
.59	5800		.35	.47	1.28	1.59	.53	.94	1.06	51.8	11.70				
15	400	G 1/2	12	14	35	43	14	27	27	90	6,62	FI-GE-15LR-WD-B-W3			
.59	5800		.47	.55	1.38	1.69	.55	1.06	1.06	66.6	14.56				
15	250	G 3/4	12	16	38	46	15	32	27	180	11,80	FI-GE-15LR3/4-WD-B-W3			
.59	3625		.47	.63	1.50	1.81	.59	1.26	1.06	133.2	25.96				
18	400	G 3/8	9	12	33,5	42,5	14	27	32	70	6,56	FI-GE-18LR3/8-WD-B-W3			
.71	5800		.35	.47	1.32	1.67	.55	1.06	1.26	51.8	14.44				
18	400	G 1/2	14	14	36	45	14,5	27	32	90	7,01	FI-GE-18LR-WD-B-W3			
.71	5800		.55	.55	1.42	1.77	.57	1.06	1.26	66.6	15.41				
18	250	G 3/4	15	16	38	47	14,5	32	32	180	10,89	FI-GE-18LR3/4-WD-B-W3			
.71	3625		.59	.63	1.50	1.85	.57	1.26	1.26	133.2	23.96				

¹ Approximate dimension in assembled condition.

² Weight excluding cutting ring and union nut.

³ Standard scope of delivery: Fitting body only.

Male stud acc. to ISO 1179-2 (Type E)

Port acc. to ISO 1179-1

Torque recommendations for Steel mating material.

Standard seal material is NBR (Buna-N®).



Straight Male Stud Fitting
Type FI-GE-...-R-WD • Series L

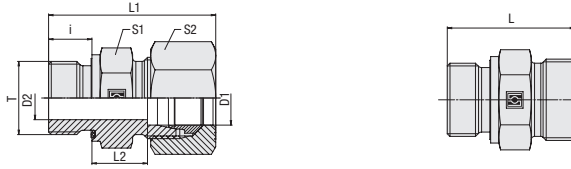

C

Profile Sealing Ring

Whitworth Parallel Pipe Thread (BSPP)

Series	Tube OD (mm/in)	PN (bar/PSI)	Dimensions (mm/in)										Torque (N•m/ft•lb)	Weight (kg/lbs) Ca.	Ordering Codes ³
			Thread	T	D2	i	L	L1 ¹	L2	S1	S2	Thread T			
L	22	250	G 1/2	14	14	38	47	16,5	32	36	90	8,75	FI-GE-22LR1/2-WD-B-W3		
	.87	3625		.55	.55	1.50	1.85	.65	1.26	1.42	66.6	19.25			
	22	250	G 3/4	18	16	40	49	16,5	32	36	180	10,28	FI-GE-22LR-WD-B-W3		
	.87	3625		.71	.63	1.57	1.93	.65	1.26	1.42	133.2	22.61			
	22	250	G 1	19	18	43	52	17,5	41	36	310	18,57	FI-GE-22LR1-WD-B-W3		
	.87	3625		.75	.71	1.69	2.05	.69	1.61	1.42	229.4	40.85			
	28	250	G 3/4	18	16	41	50	17,5	41	41	180	14,97	FI-GE-28LR3/4-WD-B-W3		
	1.10	3625		.71	.63	1.61	1.97	.69	1.61	1.61	133.2	32.93			
	28	250	G 1	24	18	43	52	17,5	41	41	310	15,83	FI-GE-28LR-WD-B-W3		
	1.10	3625		.94	.71	1.69	2.05	.69	1.61	1.61	229.4	34.82			
	28	250	G 1 1/4	24	20	45	54	17,5	50	41	450	13,40	FI-GE-28LR1-1/4-WD-B-W3		
	1.10	3625		.94	.79	1.77	2.13	.69	1.97	1.61	333.0	29.48			
	35	250	G 3/4	18	16	44	55	17	46	50	180	20,71	FI-GE-35LR3/4-WD-B-W3		
	1.38	3625		.71	.63	1.73	2.17	.67	1.81	1.97	133.2	45.56			
	35	250	G 1	23	18	46	57	17,5	46	50	310	22,15	FI-GE-35LR1-WD-B-W3		
	1.38	3625		.91	.71	1.81	2.24	.69	1.81	1.97	229.4	48.74			
	35	250	G 1 1/4	30	20	48	59	17,5	50	50	450	27,23	FI-GE-35LR-WD-B-W3		
	1.38	3625		1.18	.79	1.89	2.32	.69	1.97	1.97	333.0	59.90			
	35	250	G 1 1/2	30	22	52	63	19,5	55	50	540	42,18	FI-GE-35LR1-1/2-WD-B-W3		
	1.38	3625		1.18	.87	2.05	2.48	.77	2.17	1.97	399.6	92.80			
42	250	G 1	23	18	48	60	19	55	60	310	31,72	FI-GE-42LR1-WD-B-W3			
1.65	3625		.91	.71	1.89	2.36	.75	2.17	2.36	229.4	69.78				
42	250	G 1 1/4	30	20	50	62	19	55	60	450	34,03	FI-GE-42LR1-1/4-WD-B-W3			
1.65	3625		1.18	.79	1.97	2.44	.75	2.17	2.36	333.0	74.87				
42	250	G 1 1/2	36	22	52	64	19	55	60	540	34,37	FI-GE-42LR-WD-B-W3			
1.65	3625		1.42	.87	2.05	2.52	.75	2.17	2.36	399.6	75.62				

¹ Approximate dimension in assembled condition.
² Weight excluding cutting ring and union nut.
³ Standard scope of delivery: Fitting body only.

Male stud acc. to ISO 1179-2 (Type E)
 Port acc. to ISO 1179-1

Torque recommendations for Steel mating material.

Standard seal material is NBR (Buna-N®).

Ordering Codes

***FI-GE*-10*L*R*-WD*-B*-W3*-MS**

- * Straight Male Stud Fitting **FI-GE**
- * Outside Tube Diameter D1 (in mm) **-10**
- * Series Light Series (pages 44/45) **L**
Heavy Series (pages 46/47) **S**
- * Thread Type Whitworth Parallel Pipe Thread (BSPP) **R**

If required, please indicate special sizes, e.g. R1/8!

- * Seal Type Profile Sealing Ring **-WD**
- * Seal Material NBR (Buna-N®) **-B**
FKM (Viton®) **-V**
EPDM **-E**
- * Material Code Steel, zinc/nickel-plated **-W3**

Please contact STAUFF for alternative materials and surface finishings.

- * Assembling / Kitting Fitting body only **—**
Fitting body supplied with cutting ring and union nut **-MS**
Fitting body supplied with soft-sealing cutting ring and union nut **-MSV**

Connecting Parts

- Cutting Ring
Type **FI-DS** Page 26
- Soft-Sealing Cutting Ring
Type **FI-WDDS** Page 27
- Support Sleeve
Type **FI-VH** Page 28
- STAUFF Form Ring
Type **FI-AR** Page 30
- Union Nut
Type **FI-M** Page 31
- 37° Flared Tube Fitting Set
Type **FI-AB** Page 35

Spare Parts / Accessories

- Profile Sealing Ring
Type **WDG** Page 206



Straight Male Stud Fitting
Type FI-GE-...-R-WD ■ Series S

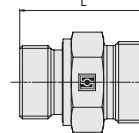
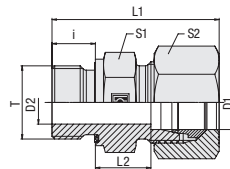

C

Whitworth Parallel Pipe Thread (BSPP)

Profile Sealing Ring

Ordering Codes

***FI-GE*-10*L*R*-WD*-B*-W3*-MS**

- * Straight Male Stud Fitting **FI-GE**
- * Outside Tube Diameter D1 (in mm) **-10**
- * Series **L**
Light Series (pages 44/45)
S
Heavy Series (pages 46/47)
- * Thread Type **R**
Whitworth Parallel
Pipe Thread (BSPP)
- If required, please indicate special sizes, e.g. R1/8!
- * Seal Type **-WD**
Profile Sealing Ring
- * Seal Material **-B**
NBR (Buna-N®)
-V
FKM (Viton®)
-E
EPDM
- * Material Code **-W3**
Steel, zinc/nickel-plated
- Please contact STAUFF for alternative materials and surface finishings.
- * Assembling / Kitting **—**
Fitting body only
- Fitting body supplied with cutting ring and union nut **-MS**
- Fitting body supplied with soft-sealing cutting ring and union nut **-MSV**

Connecting Parts

- Cutting Ring
Type **FI-DS** Page 26
- Soft-Sealing Cutting Ring
Type **FI-WDDS** Page 27
- Support Sleeve
Type **FI-VH** Page 28
- STAUFF Form Ring
Type **FI-AR** Page 30
- Union Nut
Type **FI-M** Page 31
- 37° Flared Tube Fitting Set
Type **FI-AB** Page 35

Spare Parts / Accessories

- Profile Sealing Ring
Type **WDG** Page 206

Series	Tube OD (mm/in)	PN (bar/psi)	Dimensions (mm/in)										Torque (N-m/lb-ft)	Weight (kg/lbs) ca. per 100 ²	Ordering Codes ³
			D1	Thread	T	D2	i	L	L1 ¹	L2	S1	S2			
S	6	800	G 1/8	4	8	27,5	35,5	12,5	14	17	25	2,49	FI-GE-06SR1/8-WD-B-W3		
	.24	11600		.16	.31	1.08	1.40	.49	.55	.67	18.5	5.48	FI-GE-06SR-WD-B-W3		
6	800		G 1/4	4	12	32	40	13	19	17	55	3,46	FI-GE-06SR3/8-WD-B-W3		
	.24	11600		.16	.47	1.26	1.57	.51	.75	.67	40.7	7.61	FI-GE-06SR1/2-WD-B-W3		
6	800		G 3/8	4	12	34,5	42,5	15,5	22	17	80	5,63	FI-GE-06SR1/8-WD-B-W3		
	.24	11600		.16	.47	1.36	1.67	.61	.87	.67	59.2	12.38	FI-GE-06SR1/2-WD-B-W3		
6	800		G 1/2	4	14	39	47	18	27	17	115	8,22	FI-GE-06SR1/8-WD-B-W3		
	.24	11600		.16	.55	1.54	1.85	.71	1.06	.67	85.1	18.09	FI-GE-06SR-WD-B-W3		
8	800		G 1/8	4	8	29,5	37,5	14,5	19	19	25	3,41	FI-GE-08SR3/8-WD-B-W3		
	.31	11600		.16	.31	1.16	1.48	.57	.75	.75	18.5	7.49	FI-GE-08SR1/2-WD-B-W3		
8	800		G 1/4	5	12	34	42	15	19	19	55	4,00	FI-GE-08SR3/8-WD-B-W3		
	.31	11600		.20	.47	1.34	1.65	.59	.75	.75	40.7	8.80	FI-GE-08SR1/2-WD-B-W3		
8	800		G 3/8	5	12	34,5	42,5	15,5	22	19	80	5,72	FI-GE-08SR-WD-B-W3		
	.31	11600		.20	.47	1.36	1.67	.61	.87	.75	59.2	12.58	FI-GE-08SR3/8-WD-B-W3		
8	800		G 1/2	5	14	39	47	18	27	19	115	9,92	FI-GE-10SR1/4-WD-B-W3		
	.31	11600		.20	.55	1.54	1.85	.71	1.06	.75	85.1	21.82	FI-GE-10SR-WD-B-W3		
10	800		G 1/4	5	12	34	43	14,5	19	22	55	4,22	FI-GE-10SR1/2-WD-B-W3		
	.39	11600		.20	.47	1.34	1.69	.57	.75	.87	40.7	9.28	FI-GE-10SR-WD-B-W3		
10	800		G 3/8	7	12	34,5	43,5	15	22	22	80	5,60	FI-GE-10SR1/4-WD-B-W3		
	.39	11600		.28	.47	1.36	1.71	.59	.87	.87	59.2	12.31	FI-GE-10SR-WD-B-W3		
10	800		G 1/2	7	14	39	47	17,5	27	22	115	9,57	FI-GE-12SR1/4-WD-B-W3		
	.39	11600		.28	.55	1.54	1.85	.69	1.06	.87	85.1	21.06	FI-GE-12SR1/2-WD-B-W3		
12	630		G 1/4	5	12	36	44	16,5	22	24	55	5,60	FI-GE-12SR-WD-B-W3		
	.47	9135		.20	.47	1.42	1.73	.65	.87	.94	40.7	12.32	FI-GE-12SR1/4-WD-B-W3		
12	630		G 3/8	8	12	36,5	45	17	22	24	80	6,25	FI-GE-12SR1/2-WD-B-W3		
	.47	9135		.31	.47	1.44	1.77	.67	.87	.94	59.2	13.75	FI-GE-12SR-WD-B-W3		
12	630		G 1/2	8	14	39	48	17,5	27	24	115	9,52	FI-GE-12SR3/4-WD-B-W3		
	.47	9135		.31	.55	1.54	1.89	.69	1.06	.94	85.1	20.95	FI-GE-12SR1/4-WD-B-W3		
12	630		G 3/4	8	16	41	50	17,5	32	24	180	12,83	FI-GE-12SR3/4-WD-B-W3		
	.47	9135		.31	.63	1.61	1.97	.69	1.26	.94	133.2	28.22	FI-GE-14SR3/8-WD-B-W3		
14	630		G 3/8	8	12	38,5	48,5	18,5	24	27	80	5,03	FI-GE-14SR-WD-B-W3		
	.55	9135		.31	.47	1.52	1.91	.73	.94	1.06	59.2	11.07	FI-GE-14SR3/4-WD-B-W3		
14	630		G 1/2	10	14	41	51	19	27	27	115	9,67	FI-GE-14SR1/4-WD-B-W3		
	.55	9135		.39	.55	1.61	2.01	.75	1.06	1.06	85.1	21.27	FI-GE-14SR3/4-WD-B-W3		
14	630		G 3/4	10	16	45	55	21	32	27	180	14,90	FI-GE-16SR1/4-WD-B-W3		
	.55	9135		.39	.63	1.77	2.17	.83	1.26	1.06	133.2	32.78	FI-GE-16SR3/8-WD-B-W3		
16	630		G 1/4	7	12	38	48	17,5	27	30	55	8,12	FI-GE-16SR-WD-B-W3		
	.63	9135		.28	.47	1.50	1.89	.69	1.06	1.18	40.7	17.86	FI-GE-16SR1/2-WD-B-W3		
16	630		G 3/8	8	12	38,5	48,5	18	27	30	80	7,53	FI-GE-16SR3/4-WD-B-W3		
	.63	9135		.31	.47	1.52	1.91	.71	1.06	1.18	59.2	16.57	FI-GE-16SR-WD-B-W3		
16	630		G 1/2	12	14	41	51	18,5	27	30	115	9,08	FI-GE-16SR1/4-WD-B-W3		
	.63	9135		.47	.55	1.61	2.01	.73	1.06	1.18	85.1	19.98	FI-GE-16SR3/4-WD-B-W3		
16	630		G 3/4	12	16	45	55	20,5	32	30	180	15,51	FI-GE-16SR1/2-WD-B-W3		
	.63	9135		.47	.63	1.77	2.17	.81	1.26	1.18	133.2	34.13	FI-GE-16SR-WD-B-W3		
16	400		G 1	12	18	49	59	22,5	41	30	310	25,20	FI-GE-16SR3/4-WD-B-W3		
	.63	5800		.47	.71	1.93	2.32	.89	1.61	1.18	229.4	55.43	FI-GE-16SR1-WD-B-W3		

¹ Approximate dimension in assembled condition.

² Weight excluding cutting ring and union nut.

³ Standard scope of delivery: Fitting body only.

Male stud acc. to ISO 1179-2 (Type E)

Port acc. to ISO 1179-1

Torque recommendations for Steel mating material.

Standard seal material is NBR (Buna-N®).



**Straight Male Stud Fitting
Type FI-GE-...-R-WD ▪ Series S**

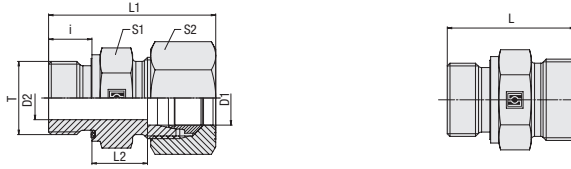

C

Profile Sealing Ring

Whitworth Parallel Pipe Thread (BSPP)

Series	Tube OD (mm/in)	PN (bar/PSI)	Dimensions (mm/in)									Torque (N·m/ft·lb)	Weight (kg/lbs) Ca.	Ordering Codes ³
			Thread	T	D2	i	L	L1 ¹	L2	S1	S2			
S	20	400	G 1/2	12	14	45	56	2.5	32	36	115	13,76	FI-GE-20SR1/2-WD-B-W3	
	.79	5800		.47	.55	1.77	2.20	.81	1.26	1.42	85.1	30.28		
	20	400	G 3/4	16	16	47	58	2.5	32	36	180	14,86	FI-GE-20SR-WD-B-W3	
	.79	5800		.63	.63	1.85	2.28	.81	1.26	1.42	133.2	32.70		
	20	400	G 1	16	18	51	62	22,5	41	36	310	21,90	FI-GE-20SR1-WD-B-W3	
	.79	5800		.63	.71	2.01	2.44	.89	1.61	1.42	229.4	48.19		
	20	400	G 1 1/4	16	20	53	64	22,5	50	36	450	13,50	FI-GE-20SR1-1/4-WD-B-W3	
	.79	5800		.63	.79	2.09	2.52	.89	1.97	1.42	333.0	29.70		
	25	400	G 1/2	12	14	49	61	23	41	46	115	23,49	FI-GE-25SR1/2-WD-B-W3	
	.98	5800		.47	.55	1.93	2.40	.91	1.61	1.81	85.1	51.68		
	25	400	G 3/4	16	16	51	63	23	41	46	180	20,33	FI-GE-25SR3/4-WD-B-W3	
	.98	5800		.63	.63	2.01	2.48	.91	1.61	1.81	133.2	44.73		
	25	400	G 1	20	18	53	65	23	41	46	310	26,75	FI-GE-25SR-WD-B-W3	
	.98	5800		.79	.71	2.09	2.56	.91	1.61	1.81	229.4	58.84		
	25	400	G 1 1/4	20	20	55	67	23	50	46	450	23,28	FI-GE-25SR1-1/4-WD-B-W3	
	.98	5800		.79	.79	2.17	2.64	.91	1.97	1.81	333.0	51.22		
	30	400	G 3/4	16	16	53	66	23,5	46	50	180	31,16	FI-GE-30SR3/4-WD-B-W3	
	1.18	5800		.63	.63	2.09	2.60	.93	1.81	1.97	133.2	68.56		
	30	400	G 1	20	18	55	68	23,5	46	50	310	33,20	FI-GE-30SR1-WD-B-W3	
	1.18	5800		.79	.71	2.17	2.68	.93	1.81	1.97	229.4	73.04		
	30	400	G 1 1/4	25	20	57	70	23,5	50	50	450	41,74	FI-GE-30SR-WD-B-W3	
	1.18	5800		.98	.79	2.24	2.76	.93	1.97	1.97	333.0	91.82		
	30	400	G 1 1/2	25	22	62	75	26,5	55	50	540	54,30	FI-GE-30SR1-1/2-WD-B-W3	
	1.18	5800		.98	.87	2.44	2.95	1.04	2.17	1.97	399.6	119.46		
38	400	G 1	20	18	60	75	26	55	50	310	52,00	FI-GE-38SR1-WD-B-W3		
1.50	5800		.79	.71	2.36	2.95	1.02	2.17	1.97	229.4	114.40			
38	400	G 1 1/4	25	20	62	77	26	55	60	450	57,22	FI-GE-38SR1-1/4-WD-B-W3		
1.50	5800		.98	.79	2.44	3.03	1.02	2.17	2.36	333.0	125.88			
38	400	G 1 1/2	32	22	64	79	26	55	60	540	55,90	FI-GE-38SR-WD-B-W3		
1.50	5800		1.26	.87	2.52	3.11	1.02	2.17	2.36	399.6	122.98			

Ordering Codes

***FI-GE*-10*L*R*-WD*-B*-W3*-MS**

- * Straight Male Stud Fitting **FI-GE**
- * Outside Tube Diameter D1 (in mm) **-10**
- * Series Light Series (pages 44/45) **L**
Heavy Series (pages 46/47) **S**
- * Thread Type Whitworth Parallel Pipe Thread (BSPP) **R**

If required, please indicate special sizes, e.g. R1/8!

- * Seal Type Profile Sealing Ring **-WD**
- * Seal Material NBR (Buna-N®) **-B**
FKM (Viton®) **-V**
EPDM **-E**
- * Material Code Steel, zinc/nickel-plated **-W3**

Please contact STAUFF for alternative materials and surface finishings.

- * Assembling / Kitting Fitting body only **—**
Fitting body supplied with cutting ring and union nut **-MS**
Fitting body supplied with soft-sealing cutting ring and union nut **-MSV**

¹ Approximate dimension in assembled condition.
² Weight excluding cutting ring and union nut.
³ Standard scope of delivery: Fitting body only.

Male stud acc. to ISO 1179-2 (Type E)
 Port acc. to ISO 1179-1

Torque recommendations for Steel mating material.

Standard seal material is NBR (Buna-N®).

Connecting Parts

- Cutting Ring Type **FI-DS** Page 26
- Soft-Sealing Cutting Ring Type **FI-WDDS** Page 27
- Support Sleeve Type **FI-VH** Page 28
- STAUFF Form Ring Type **FI-AR** Page 30
- Union Nut Type **FI-M** Page 31
- 37° Flared Tube Fitting Set Type **FI-AB** Page 35

Spare Parts / Accessories

- Profile Sealing Ring Type **WDG** Page 206



Straight Male Stud Fitting
Type FI-GE-...-M-WD ▪ Series L

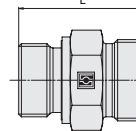
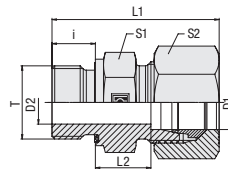

C

Ordering Codes

***FI-GE*-10*L*M*-WD*-B*-W3*-MS**

- * Straight Male Stud Fitting **FI-GE**
- * Outside Tube Diameter D1 (in mm) **-10**
- * Series Light Series (page 48) **L**
Heavy Series (page 49) **S**
- * Thread Type Metric Parallel Thread **M**
If required, please indicate special sizes, e.g. M12x1.5!
- * Seal Type Profile Sealing Ring **-WD**
- * Seal Material NBR (Buna-N®) **-B**
FKM (Viton®) **-V**
EPDM **-E**
- * Material Code Steel, zinc/nickel-plated **-W3**
Please contact STAUFF for alternative materials and surface finishings.
- * Assembling / Kitting Fitting body only **—**
Fitting body supplied with cutting ring and union nut **-MS**
Fitting body supplied with soft-sealing cutting ring and union nut **-MSV**

Connecting Parts

-  Cutting Ring Type **FI-DS** Page 26
-  Soft-Sealing Cutting Ring Type **FI-WDDS** Page 27
-  Support Sleeve Type **FI-VH** Page 28
-  STAUFF Form Ring Type **FI-AR** Page 30
-  Union Nut Type **FI-M** Page 31
-  37° Flared Tube Fitting Set Type **FI-AB** Page 35

Spare Parts / Accessories

-  Profile Sealing Ring Type **WDG** Page 206

Metric Parallel Thread

Profile Sealing Ring

Series	Tube OD (mm/in)	PN (bar/psi)	Dimensions (mm/in)										Torque (N-m/ft-lb)	Weight (kg/lbs) ca. per 100 ²	Ordering Codes ³
			Thread	D2	i	L	L1 ¹	L2	S1	S2	Thread T				
L	6	500	M 10 x 1	4	8	23,5	31,5	8,5	14	14	18	1,36	FI-GE-06LM-WD-B-W3		
	.24	7250		.16	.31	.93	1.24	.33	.55	.55	13.3	2.99			
	6	500	M 12 x 1,5	4	12	29	37	10	17	14	25	2,26	FI-GE-06LM12x1.5-WD-B-W3		
	.24	7250		.16	.47	1.14	1.46	.39	.67	.55	18.5	4.98			
	8	500	M 10 x 1	4	8	23,5	31,5	8,5	14	17	18	1,54	FI-GE-08LM10x1-WD-B-W3		
	.31	7250		.16	.31	.93	1.24	.33	.55	.67	13.3	3.39			
	8	500	M 12 x 1,5	6	12	29	37	10	17	17	25	2,16	FI-GE-08LM-WD-B-W3		
	.31	7250		.24	.47	1.14	1.46	.39	.67	.67	18.5	4.75			
	8	500	M 14 x 1,5	6	12	29	37	10	19	17	45	3,11	FI-GE-08LM14x1.5-WD-B-W3		
	.31	7250		.24	.47	1.14	1.46	.39	.75	.67	33.3	6.83			
	8	400	M 16 x 1,5	6	12	30	38	11	22	17	55	4,05	FI-GE-08LM16x1.5-WD-B-W3		
	.31	5800		.24	.47	1.18	1.50	.43	.87	.67	40.7	8.91			
	10	400	M 12 x 1,5	6	12	30	38	11	17	19	25	2,38	FI-GE-10LM12x1.5-WD-B-W3		
	.39	5800		.24	.47	1.18	1.50	.43	.67	.75	18.5	5.23			
	10	400	M 14 x 1,5	7	12	30	38	11	19	19	45	2,88	FI-GE-10LM-WD-B-W3		
	.39	5800		.28	.47	1.18	1.50	.43	.75	.75	33.3	6.33			
	10	400	M 16 x 1,5	8	12	31,5	39,5	12,5	22	19	55	4,05	FI-GE-10LM16x1.5-WD-B-W3		
	.39	5800		.31	.47	1.24	1.56	.49	.87	.75	40.7	8.91			
	10	400	M 18 x 1,5	8	12	31,5	39,5	12,5	24	19	70	4,94	FI-GE-10LM18x1.5-WD-B-W3		
	.39	5800		.31	.47	1.24	1.56	.49	.94	.75	51.8	10.86			
	10	400	M 22 x 1,5	8	14	34	42	13	27	19	125	7,36	FI-GE-10LM22x1.5-WD-B-W3		
	.39	5800		.31	.55	1.34	1.65	.51	1.06	.75	92.5	16.19			
	12	400	M 12 x 1,5	4	12	32	40	11	19	22	25	2,84	FI-GE-12LM12x1.5-WD-B-W3		
	.47	5800		.16	.47	1.26	1.57	.43	.75	.87	18.5	6.25			
	12	400	M 14 x 1,5	7	12	30	38	11	19	22	45	3,06	FI-GE-12LM14x1.5-WD-B-W3		
	.47	5800		.28	.47	1.18	1.50	.43	.75	.87	33.3	6.72			
	12	400	M 16 x 1,5	9	12	31,5	39,5	12,5	22	22	55	3,94	FI-GE-12LM-WD-B-W3		
	.47	5800		.35	.47	1.24	1.56	.49	.87	.87	40.7	8.66			
	12	400	M 18 x 1,5	10	12	31,5	39,5	12,5	24	22	70	4,90	FI-GE-12LM18x1.5-WD-B-W3		
	.47	5800		.39	.47	1.24	1.56	.49	.94	.87	51.8	10.78			
	12	400	M 22 x 1,5	10	14	34	42	13	27	22	125	6,96	FI-GE-12LM22x1.5-WD-B-W3		
	.47	5800		.39	.55	1.34	1.65	.51	1.06	.87	92.5	15.31			
	15	400	M 16 x 1,5	9	12	32,5	40,5	13,5	24	27	55	5,15	FI-GE-15LM16x1.5-WD-B-W3		
	.59	5800		.35	.47	1.28	1.59	.53	.94	1.06	40.7	11.33			
	15	400	M 18 x 1,5	11	12	32,5	40,5	13,5	24	27	70	5,05	FI-GE-15LM-WD-B-W3		
	.59	5800		.43	.47	1.28	1.59	.53	.94	1.06	51.8	11.11			
	15	400	M 22 x 1,5	12	14	35	43	14	27	27	125	7,15	FI-GE-15LM22x1.5-WD-B-W3		
	.59	5800		.47	.55	1.38	1.69	.55	1.06	1.06	92.5	15.73			
	18	400	M 18 x 1,5	11	12	33,5	42,5	14	27	32	90	6,26	FI-GE-18LM18x1.5-WD-B-W3		
	.71	5800		.43	.47	1.32	1.67	.55	1.06	1.26	66.6	13.77			
	18	400	M 22 x 1,5	14	14	36	45	14,5	27	32	125	7,43	FI-GE-18LM-WD-B-W3		
	.71	5800		.55	.55	1.42	1.77	.57	1.06	1.26	92.5	16.35			
	22	250	M 22 x 1,5	14	14	38	47	16,5	32	36	125	9,10	FI-GE-22LM22x1.5-WD-B-W3		
	.87	3625		.55	.55	1.50	1.85	.65	1.26	1.42	92.5	20.02			
	22	250	M 26 x 1,5	18	16	40	49	16,5	32	36	180	10,23	FI-GE-22LM-WD-B-W3		
	.87	3625		.71	.63	1.57	1.93	.65	1.26	1.42	133.2	22.51			
	28	250	M 33 x 2	23	18	43	52	17,5	41	41	310	16,76	FI-GE-28LM-WD-B-W3		
	1.10	3625		.91	.71	1.69	2.05	.69	1.61	1.61	229.4	36.87			
	35	250	M 42 x 2	30	20	48	59	17,5	50	50	450	27,63	FI-GE-35LM-WD-B-W3		
	1.38	3625		1.18	.79	1.89	2.32	.69	1.97	1.97	333.0	60.79			
	42	250	M 48 x 2	36	22	52	64	19	55	60	540	34,63	FI-GE-42LM-WD-B-W3		
	1.65	3625		1.42	.87	2.05	2.52	.75	2.17	2.36	399.6	76.19			

¹ Approximate dimension in assembled condition.

² Weight excluding cutting ring and union nut.

³ Standard scope of delivery: Fitting body only.

Male stud acc. to ISO 9974-2 (Type E)

Port acc. to ISO 9974-1

Torque recommendations for Steel mating material.

Standard seal material is NBR (Buna-N®).



Straight Male Stud Fitting
Type FI-GE-...-M-WD ▪ Series S

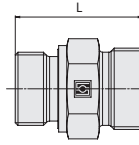
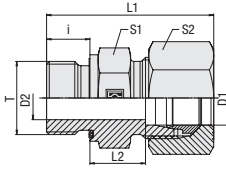

C

Profile Sealing Ring

Metric Parallel Thread

Series	Tube OD (mm/in)	PN (bar/psi)	Dimensions (mm/in)										Torque (N·m/ft·lb)	Weight (kg/lbs) Ca. per 100 ²	Ordering Codes ³
			Thread	T	D2	i	L	L ¹	L2	S1	S2	Thread T			
S	6	800	M 12 x 1,5	4	12	32	40	13	17	17	35	2,93	FI-GE-06SM-WD-B-W3		
	.24	11600		.16	.47	1.26	1.57	.51	.67	.67	25.9	6.44			
	8	800	M 14 x 1,5	5	12	34	42	15	19	19	55	4,16	FI-GE-08SM-WD-B-W3		
	.31	11600		.20	.47	1.34	1.65	.59	.75	.75	40.7	9.16			
	10	800	M 14 x 1,5	5	12	34,5	43,5	15	19	22	55	4,97	FI-GE-10SM14x1.5-WD-B-W3		
	.39	11600		.20	.47	1.36	1.71	.59	.75	.87	40.7	10.93			
	10	800	M 16 x 1,5	7	12	34,5	43,5	15	22	22	70	5,36	FI-GE-10SM-WD-B-W3		
	.39	11600		.28	.47	1.36	1.71	.59	.87	.87	51.8	11.79			
	12	630	M 14 x 1,5	5	12	36	45	16,5	22	24	55	6,00	FI-GE-12SM14x1.5-WD-B-W3		
	.47	9135		.20	.47	1.42	1.77	.65	.87	.94	40.7	13.20			
	12	630	M 16 x 1,5	8	12	36	45	16,5	22	24	70	6,12	FI-GE-12SM16x1.5-WD-B-W3		
	0,47	9135		.31	.47	1.42	1.77	.65	.87	.94	51.8	13.47			
	12	630	M 18 x 1,5	8	12	36,5	45,5	17	24	24	90	7,12	FI-GE-12SM-WD-B-W3		
	.47	9135		.31	.47	1.44	1.79	.67	.94	.94	66.6	15.67			
	12	630	M 22 x 1,5	8	14	39	48	17,5	27	24	135	9,28	FI-GE-12SM22x1.5-WD-B-W3		
	.47	9135		.31	.55	1.54	1.89	.69	1.06	.94	99.9	20.42			
	14	630	M 20 x 1,5	10	14	41	51	19	27	27	125	9,46	FI-GE-14SM-WD-B-W3		
	.55	9135		.39	.55	1.61	2.01	.75	1.06	1.06	92.5	20.82			
	16	630	M 18 x 1,5	8	12	38,5	48,5	18	24	30	90	7,82	FI-GE-16SM18x1.5-WD-B-W3		
	.63	9135		.31	.47	1.52	1.91	.71	.94	1.18	66.6	17.20			
16	630	M 22 x 1,5	12	14	41	51	18,5	27	30	135	9,52	FI-GE-16SM-WD-B-W3			
.63	9135		.47	.55	1.61	2.01	.73	1.06	1.18	99.9	20.95				
20	400	M 27 x 2	16	16	47	58	20,5	32	36	180	15,10	FI-GE-20SM-WD-B-W3			
.79	5800		.63	.63	1.85	2.28	.81	1.26	1.42	133.2	33.22				
25	400	M 33 x 2	20	18	53	65	23	41	46	310	26,43	FI-GE-25SM-WD-B-W3			
.98	5800		.79	.71	2.09	2.56	.91	1.61	1.81	229.4	58.15				
30	400	M 42 x 2	25	20	57	70	23,5	50	50	450	41,84	FI-GE-30SM-WD-B-W3			
1.18	5800		.98	.79	2.24	2.76	.93	1.97	1.97	333.0	92.06				
38	400	M 48 x 2	32	22	64	79	26	55	60	540	57,00	FI-GE-38SM-WD-B-W3			
1.50	5800		1.26	.87	2.52	3.11	1.02	2.17	2.36	399.6	125.40				

¹ Approximate dimension in assembled condition.

² Weight excluding cutting ring and union nut.

³ Standard scope of delivery: Fitting body only.

Standard seal material is NBR (Buna-N®).

Male stud acc. to ISO 9974-2 (Type E)

Port acc. to ISO 9974-1

Torque recommendations for Steel mating material.

Ordering Codes

***FI-GE*-10*L*M*-WD*-B*-W3*-MS**

- * Straight Male Stud Fitting FI-GE
 - * Outside Tube Diameter D1 (in mm) -10
 - * Series Light Series (page 48) L
Heavy Series (page 49) S
 - * Thread Type Metric Parallel Thread M
- If required, please indicate special sizes, e.g. M12x1.5!
- * Seal Type Profile Sealing Ring -WD
 - * Seal Material NBR (Buna-N®) -B
FKM (Viton®) -V
EPDM -E
 - * Material Code Steel, zinc/nickel-plated -W3

Please contact STAUFF for alternative materials and surface finishings.

- * Assembling / Kitting Fitting body only —
- Fitting body supplied with cutting ring and union nut -MS
- Fitting body supplied with soft-sealing cutting ring and union nut -MSV

Connecting Parts

-  Cutting Ring
Type **FI-DS** Page 26
-  Soft-Sealing Cutting Ring
Type **FI-WDDS** Page 27
-  Support Sleeve
Type **FI-VH** Page 28
-  STAUFF Form Ring
Type **FI-AR** Page 30
-  Union Nut
Type **FI-M** Page 31
-  37° Flared Tube Fitting Set
Type **FI-AB** Page 35

Spare Parts / Accessories

-  Profile Sealing Ring
Type **WDG** Page 206



Straight Male Stud Fitting
Type FI-GE-...-R-DF ▪ Series L

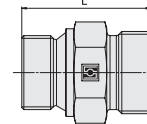
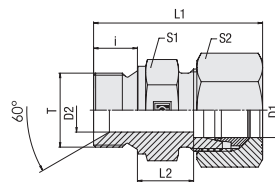

C

Whitworth Parallel Pipe Thread (BSPP)

60° Conical Bore / Sealing Surface for Gaskets

Ordering Codes

FI-GE-10*L*R*-DF*-W3*-MS

* Straight Male Stud Fitting **FI-GE**

* Outside Tube Diameter D1 (in mm) **-10**

* Series Light Series (page 50) **L**
Heavy Series (page 51) **S**

* Thread Type Whitworth Parallel Pipe Thread (BSPP) **R**

If required, please indicate special sizes, e.g. R1/8!

* Seal Type 60° Conical Bore (BS 5200) / Sealing Surface for Gasket (DIN 7603) **-DF**

* Material Code Steel, zinc/nickel-plated **-W3**

Please contact STAUFF for alternative materials and surface finishings.

* Assembling / Kitting Fitting body only **—**

Fitting body supplied with cutting ring and union nut **-MS**

Fitting body supplied with soft-sealing cutting ring and union nut **-MSV**

Connecting Parts



Cutting Ring
Type **FI-DS** Page 26



Soft-Sealing Cutting Ring
Type **FI-WDDS** Page 27



Support Sleeve
Type **FI-VH** Page 28



STAUFF Form Ring
Type **FI-AR** Page 30



Union Nut
Type **FI-M** Page 31



37° Flared Tube Fitting Set
Type **FI-AB** Page 35

Series	Tube OD (mm/in)	PN (bar/psi)	Dimensions (mm/in)										Torque (N-m/ft-lb)	Weight (kg/lbs) ca.	Ordering Codes ³
			D1	Thread	T	D2	i	L	L ¹	L2	S1	S2			
L	6	500	G 1/8	3,5	8	23,5	31,5	8,5	14	14	20	1,38	FI-GE-06LR-DF-W3		
	.24	7250		.14	.31	.93	1.24	.33	.55	.55	14.8	3.04			
6	500		G 1/4	4	12	29	36	10	19	14	50	2,75	FI-GE-06LR1/4-DF-W3		
	.24	7250		.16	.47	1.14	1.42	.39	.75	.55	37.0	6.05			
6	500		G 3/8	7,9	12	30,5	38	11	22	14	80	3,94	FI-GE-06LR3/8-DF-W3		
	.24	7250		.31	.47	1.20	1.50	.43	.87	.55	59.2	8.68			
8	500		G 1/8	3,5	8	24,5	32	10	14	17	20	1,71	FI-GE-08LR1/8-DF-W3		
	.31	7250		.14	.31	.96	1.26	.39	.55	.67	14.8	3.76			
8	500		G 1/4	4,7	12	29	37	10	19	17	50	2,87	FI-GE-08LR-DF-W3		
	.31	7250		.19	.47	1.14	1.46	.39	.75	.67	37.0	6.31			
8	500		G 3/8	6	12	30,5	38	11	22	17	80	4,28	FI-GE-08LR3/8-DF-W3		
	.31	7250		.24	.47	1.20	1.50	.43	.87	.67	59.2	9.41			
10	500		G 1/4	4,7	12	30	38	11	19	19	80	2,82	FI-GE-10LR-DF-W3		
	.39	7250		.19	.47	1.18	1.50	.43	.75	.75	59.2	6.21			
10	500		G 3/8	7,9	12	31,5	39	12,5	22	19	80	4,18	FI-GE-10LR3/8-DF-W3		
	.39	7250		.31	.47	1.24	1.54	.49	.87	.75	59.2	9.19			
10	500		G 1/2	11,1	14	34	41	13	27	19	140	6,28	FI-GE-10LR1/2-DF-W3		
	.39	7250		.44	.55	1.34	1.61	.51	1.06	.75	103.6	13.81			
12	400		G 1/4	4,7	12	31	39	12	19	22	50	3,30	FI-GE-12LR1/4-DF-W3		
	.47	5800		.19	.47	1.22	1.54	.47	.75	.87	37.0	7.26			
12	400		G 3/8	7,9	12	31,5	39,5	12,5	22	22	80	4,39	FI-GE-12LR-DF-W3		
	.47	5800		.31	.47	1.24	1.56	.49	.87	.87	59.2	9.66			
12	400		G 1/2	10	14	34	42	13	27	22	140	6,47	FI-GE-12LR1/2-DF-W3		
	.47	5800		.39	.55	1.34	1.65	.51	1.06	.87	103.6	14.23			
15	400		G 3/8	7,9	12	32,5	40	13,5	24	27	80	5,18	FI-GE-15LR3/8-DF-W3		
	.59	5800		.31	.47	1.28	1.57	.53	.94	1.06	59.2	11.39			
15	400		G 1/2	11,1	14	35	40,5	14	27	27	140	6,98	FI-GE-15LR-DF-W3		
	.59	5800		.44	.55	1.38	1.59	.55	1.06	1.06	103.6	15.35			
18	400		G 3/8	7,9	12	33,5	41	14	27	32	80	4,90	FI-GE-18LR3/8-DF-W3		
	.71	5800		.31	.47	1.32	1.61	.55	1.06	1.26	59.2	10.78			
18	400		G 1/2	11,1	14	35	45	13,5	27	32	140	5,35	FI-GE-18LR-DF-W3		
	.71	5800		.44	.55	1.38	1.77	.53	1.06	1.26	103.6	11.77			
18	400		G 3/4	15	16	38	47	14,5	32	32	190	10,79	FI-GE-18LR3/4-DF-W3		
	.71	5800		.59	.63	1.50	1.85	.57	1.26	1.26	140.6	23.74			
22	250		G 1/2	11,1	14	38	47	16,5	32	36	140	9,53	FI-GE-22LR1/2-DF-W3		
	.87	3625		.44	.55	1.50	1.85	.65	1.26	1.42	103.6	20.96			
22	250		G 3/4	16,7	16	40	49	16,5	32	36	190	9,94	FI-GE-22LR-DF-W3		
	.87	3625		.66	.63	1.57	1.93	.65	1.26	1.42	140.6	21.88			
22	250		G 1	22,2	18	43	51	17,5	41	36	330	16,58	FI-GE-22LR1-DF-W3		
	.87	3625		.87	.71	1.69	2.01	.69	1.61	1.42	244.2	36.48			
28	250		G 1/2	11,1	14	39	48	17,5	41	41	140	13,58	FI-GE-28LR1/2-DF-W3		
	1.10	3625		.44	.55	1.54	1.89	.69	1.61	1.61	103.6	29.88			
28	250		G 3/4	16,7	16	41	50	17,5	41	41	190	15,87	FI-GE-28LR3/4-DF-W3		
	1.10	3625		.66	.63	1.61	1.97	.69	1.61	1.61	140.6	34.91			
28	250		G 1	22,2	18	43	52	17,5	41	41	330	17,46	FI-GE-28LR-DF-W3		
	1.10	3625		.87	.71	1.69	2.05	.69	1.61	1.61	244.2	38.41			
28	250		G 1 1/4	28,6	20	48	57	20,5	50	41	540	20,04	FI-GE-28LR1-1/4-DF-W3		
	1.10	3625		1.13	.79	1.89	2.24	.81	1.97	1.61	399.6	44.09			
35	250		G 1	22,2	18	46	57	17,5	50	50	330	24,26	FI-GE-35LR1-DF-W3		
	1.38	3625		.87	.71	1.81	2.24	.69	1.97	1.97	244.2	53.37			
35	250		G 1 1/4	28,6	20	48	59	17,5	50	50	540	28,81	FI-GE-35LR-DF-W3		
	1.38	3625		1.13	.79	1.89	2.32	.69	1.97	1.97	399.6	63.37			
42	250		G 1 1/4	28,6	20	50	62	19	55	60	540	33,91	FI-GE-42LR1-1/4-DF-W3		
	1.65	3625		1.13	.79	1.97	2.44	.75	2.17	2.36	399.6	74.59			
42	250		G 1 1/2	33,3	22	52	64	19	55	60	630	36,75	FI-GE-42LR-DF-W3		
	1.65	3625		1.31	.87	2.05	2.52	.75	2.17	2.36	466.2	80.85			

¹ Approximate dimension in assembled condition.

² Weight excluding cutting ring and union nut.

³ Standard scope of delivery: Fitting body only.

Male stud acc. to DIN 3852-2 (Form A)

Port acc. to DIN 3852-2 (Form X) / ISO 1179-1

Torque recommendations for Steel mating material.



Straight Male Stud Fitting
Type FI-GE-...-R-DF • Series S

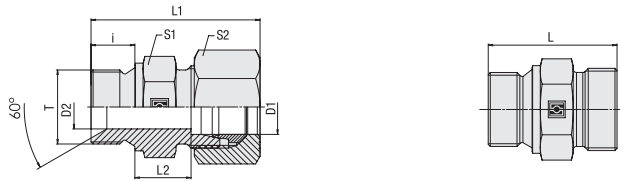

C

60° Conical Bore / Sealing Surface for Gaskets

Whitworth Parallel Pipe Thread (BSPP)







Series	Tube OD (mm/in)	PN (bar/psi)	Dimensions (mm/in)									Torque (N-m/lb-ft)	Weight (kg/lbs) ca. per 100 ²	Ordering Codes ³
			D1	Thread	T	D2	i	L	L1 ¹	L2	S1			
S	6	800	G 1/8	3,5	8	27,5	35	12,5	14	17		2,09	FI-GE-06SR1/8-DF-W3	
	.24	11600		.14	.31	1.08	1.38	.49	.55	.67		4.59		
6	800		G 1/4	4	12	32	40	13	19	17	60	3,48	FI-GE-06SR-DF-W3	
	.24	11600		.16	.47	1.26	1.57	.51	.75	.67	44.4	7.66		
6	800		G 3/8	7,9	12	34,5	42	15,5	22	17	100	4,63	FI-GE-06SR3/8-DF-W3	
	.24	11600		.31	.47	1.36	1.65	.61	.87	.67	74.0	10.18		
6	800		G 1/2	11,1	14	35	43	14	27	17	160	6,22	FI-GE-06SR1/2-DF-W3	
	.24	11600		.44	.55	1.38	1.69	.55	1.06	.67	118.4	13.68		
8	800		G 1/8	3,5	8	27,5	35	12,5	14	17		2,71	FI-GE-08SR1/8-DF-W3	
	.31	11600		.14	.31	1.08	1.38	.49	.55	.67		5.97		
8	800		G 1/4	4,7	12	34	42	15	19	19	60	4,10	FI-GE-08SR-DF-W3	
	.31	11600		.19	.47	1.34	1.65	.59	.75	.75	44.4	9.01		
8	800		G 3/8	7,9	12	34,5	42	15,5	22	19	100	5,25	FI-GE-08SR3/8-DF-W3	
	.31	11600		.31	.47	1.36	1.65	.61	.87	.75	74.0	11.56		
8	800		G 1/2	11,1	14	39	47	18	27	19	160	8,47	FI-GE-08SR1/2-DF-W3	
	.31	11600		.44	.55	1.54	1.85	.71	1.06	.75	118.4	18.63		
10	800		G 1/4	4,7	12	34	42	14,5	19	22	60	4,33	FI-GE-10SR1/4-DF-W3	
	.39	11600		.19	.47	1.34	1.65	.57	.75	.87	44.4	9.52		
10	800		G 3/8	7	12	34,5	43,5	15	22	22	100	5,46	FI-GE-10SR-DF-W3	
	.39	11600		.28	.47	1.36	1.71	.59	.87	.87	74.0	12.01		
10	800		G 1/2	11,1	14	35	43	13,5	27	22	160	6,76	FI-GE-10SR1/2-DF-W3	
	.39	11600		.44	.55	1.38	1.69	.53	1.06	.87	118.4	14.87		
12	630		G 1/4	4,7	12	36	44	16,5	22	24	60	5,70	FI-GE-12SR1/4-DF-W3	
	.47	9135		.19	.47	1.42	1.73	.65	.87	.94	44.4	12.53		
12	630		G 3/8	7,9	12	36,5	45,5	17	22	24	100	6,17	FI-GE-12SR-DF-W3	
	.47	9135		.31	.47	1.44	1.79	.67	.87	.94	74.0	13.57		
12	630		G 1/2	11,1	14	39	48	17,5	27	24	160	8,75	FI-GE-12SR1/2-DF-W3	
	.47	9135		.44	.55	1.54	1.89	.69	1.06	.94	118.4	19.25		
12	630		G 3/4	16,7	16	43	51	19,5	32	24	280	12,90	FI-GE-12SR3/4-DF-W3	
	.47	9135		.66	.63	1.69	2.01	.77	1.26	.94	207.2	28.37		
14	630		G 1/2	10	14	41	51	19	27	27	160	9,56	FI-GE-14SR-DF-W3	
	.55	9135		.39	.55	1.61	2.01	.75	1.06	1.06	118.4	21.03		
16	630		G 3/8	7,9	12	38,5	48	18	27	30	100	6,82	FI-GE-16SR3/8-DF-W3	
	.63	9135		.31	.47	1.52	1.89	.71	1.06	1.18	74.0	15.01		
16	630		G 1/2	11,1	14	41	51	18,5	27	30	160	9,05	FI-GE-16SR-DF-W3	
	.63	9135		.44	.55	1.61	2.01	.73	1.06	1.18	118.4	19.92		
16	630		G 3/4	16,7	16	45	55	20,5	32	30	280	13,31	FI-GE-16SR3/4-DF-W3	
	.63	9135		.66	.63	1.77	2.17	.81	1.26	1.18	207.2	29.27		
20	420		G 1/2	11,1	14	45	54	20,5	32	36	160	13,74	FI-GE-20SR1/2-DF-W3	
	.79	6090		.44	.55	1.77	2.13	.81	1.26	1.42	118.4	30.22		
20	420		G 3/4	16	16	47	58	20,5	32	36	280	14,90	FI-GE-20SR-DF-W3	
	.79	6090		.63	.63	1.85	2.28	.81	1.26	1.42	207.2	32.77		
20	420		G 1	22,2	18	51	62	22,5	41	36	440	23,12	FI-GE-20SR1-DF-W3	
	.79	6090		.87	.71	2.01	2.44	.89	1.61	1.42	325.6	50.86		
25	420		G 1/2	11,1	14	49	56	23	41	46	160	23,68	FI-GE-25SR1/2-DF-W3	
	.98	6090		.44	.55	1.93	2.20	.91	1.61	1.81	118.4	52.10		
25	420		G 3/4	16,7	16	51	63	23	41	46	280	23,73	FI-GE-25SR3/4-DF-W3	
	.98	6090		.66	.63	2.01	2.48	.91	1.61	1.81	207.2	52.21		
25	420		G 1	20	18	53	65	23	41	46	440	20,71	FI-GE-25SR-DF-W3	
	.98	6090		.79	.71	2.09	2.56	.91	1.61	1.81	325.6	45.55		
30	420		G 3/4	16,7	16	53	66	23,5	50	50	160	33,85	FI-GE-30SR3/4-DF-W3	
	1.18	6090		.66	.63	2.09	2.60	.93	1.97	1.97	118.4	74.47		
30	420		G 1	22,2	18	55	68	23,5	46	50	440	32,20	FI-GE-30SR1-DF-W3	
	1.18	6090		.87	.71	2.17	2.68	.93	1.81	1.97	325.6	70.84		
30	420		G 1 1/4	25	20	57	70	23,5	50	50	580	40,27	FI-GE-30SR-DF-W3	
	1.18	6090		.98	.79	2.24	2.76	.93	1.97	1.97	429.2	88.59		
38	420		G 1	22,2	18	60	73	26	55	60	440	47,79	FI-GE-38SR1-DF-W3	
	1.50	6090		.87	.71	2.36	2.87	1.02	2.17	2.36	325.6	105.13		
38	420		G 1 1/4	38,6	20	62	77	26	55	60	580	51,40	FI-GE-38SR1-1/4-DF-W3	
	1.50	6090		1.52	.79	2.44	3.03	1.02	2.17	2.36	429.2	113.08		
38	420		G 1 1/2	32	22	64	79	26	55	60	700	54,70	FI-GE-38SR-DF-W3	
	1,50	6090		1.26	.87	2.52	3.11	1.02	2.17	2.36	518.0	120.34		

Ordering Codes

FI-GE-10*L*R*-DF*-W3*-MS

- * Straight Male Stud Fitting FI-GE
- * Outside Tube Diameter D1 (in mm) -10
- * Series L
Light Series (page 50)
Heavy Series (page 51) S
- * Thread Type R
Whitworth Parallel
Pipe Thread (BSPP)
- If required, please indicate special sizes, e.g. R1/8!
- * Seal Type -DF
60° Conical Bore (BS 5200) /
Sealing Surface for Gasket
(DIN 7603)
- * Material Code -W3
Steel, zinc/nickel-plated
- Please contact STAUFF for alternative materials and surface finishings.
- * Assembling / Kitting —
Fitting body only
- Fitting body supplied with cutting ring and union nut -MS
- Fitting body supplied with soft-sealing cutting ring and union nut -MSV

Connecting Parts

-  Cutting Ring
Type FI-DS Page 26
-  Soft-Sealing Cutting Ring
Type FI-WDDS Page 27
-  Support Sleeve
Type FI-VH Page 28
-  STAUFF Form Ring
Type FI-AR Page 30
-  Union Nut
Type FI-M Page 31
-  37° Flared Tube Fitting Set
Type FI-AB Page 35

¹ Approximate dimension in assembled condition.

² Weight excluding cutting ring and union nut.

³ Standard scope of delivery: Fitting body only.

Male stud acc. to DIN 3852-2 (Form A)
Port acc. to DIN 3852-2 (Form X) / ISO 1179-1

Torque recommendations for Steel mating material.



Straight Male Stud Fitting
Type FI-GE-...-M-OR • Series L / S

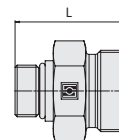
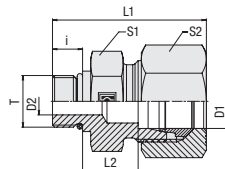

C

Metric Parallel Thread

O-Ring

Ordering Codes

***FI-GE*-10*L*M*-OR*-B*-W3*-MS**

- * Straight Male Stud Fitting **FI-GE**
- * Outside Tube Diameter D1 (in mm) **-10**
- * Series **L**
Light Series
S
Heavy Series
- * Thread Type **M**
Metric Parallel Thread
- If required, please indicate special sizes, e.g. M12x1.5!
- * Seal Type **-OR**
O-Ring
- * Seal Material **-B**
NBR (Buna-N®)
-V
FKM (Viton®)
-E
EPDM
- * Material Code **-W3**
Steel, zinc/nickel-plated
- Please contact STAUFF for alternative materials and surface finishings.
- * Assembling / Kitting Fitting body only **—**
Fitting body supplied with cutting ring and union nut **-MS**
Fitting body supplied with soft-sealing cutting ring and union nut **-MSV**

Connecting Parts

-  Cutting Ring
Type **FI-DS** Page 26
-  Soft-Sealing Cutting Ring
Type **FI-WDDS** Page 27
-  Support Sleeve
Type **FI-VH** Page 28
-  STAUFF Form Ring
Type **FI-AR** Page 30
-  Union Nut
Type **FI-M** Page 31
-  37° Flared Tube Fitting Set
Type **FI-AB** Page 35

Spare Parts / Accessories

-  O-Ring
Type **O-RING** Page 207

Series	Tube OD (mm/in)	PN (bar/psi)	Dimensions (mm/in)										Torque (N-m/lb-ft)	Weight (kg/lbs) ca. per 100 ²	Ordering Codes ³
			Thread	T	D2	i	L	L1 ¹	L2	S1	S2	Thread T			
L	6	400	M 10 x 1	4	8,5	25	33	9,5	14	14	15	1,53	FI-GE-06LM-OR-B-W3		
	.24	5800		.16	.33	.98	1.30	.37	.55	.55	11.1	3.36			
	8	400	M 12 x 1,5	6	11	28	36	10	17	17	25	2,16	FI-GE-08LM-OR-B-W3		
	.31	5800		.24	.43	1.10	1.42	.39	.67	.67	18.5	4.75			
	10	400	M 14 x 1,5	7,5	11	29	37	11	19	19	35	2,87	FI-GE-10LM-OR-B-W3		
	.39	5800		.30	.43	1.14	1.46	.43	.75	.75	25.9	6.31			
	12	400	M 16 x 1,5	9	11,5	31	39	12,5	22	22	40	4,10	FI-GE-12LM-OR-B-W3		
	.47	5800		.35	.45	1.22	1.54	.49	.87	.87	29.6	9.01			
	15	400	M 18 x 1,5	11	12,5	33	41	13,5	24	27	45	5,32	FI-GE-15LM-OR-B-W3		
	.59	5800		.43	.49	1.30	1.61	.53	.94	1.06	33.3	11.71			
	18	400	M 22 x 1,5	14	13	35	44	14,5	27	32	60	7,55	FI-GE-18LM-OR-B-W3		
	.71	5800		.55	.51	1.38	1.73	.57	1.06	1.26	44.4	16.60			
	22	250	M 27 x 2	18	16	40	49	16,5	32	36	100	10,79	FI-GE-22LM27x2-OR-B-W3		
	.87	3625		.71	.63	1.57	1.93	.65	1.26	1.42	74.0	23.73			
	28	250	M 33 x 2	23	16	41	50	17,5	41	41	160	16,73	FI-GE-28LM-OR-B-W3		
	1.10	3625		.91	.63	1.61	1.97	.69	1.61	1.61	118.4	36.81			
	35	250	M 42 x 2	30	16	44	55	17,5	50	50	210	26,66	FI-GE-35LM-OR-B-W3		
	1.38	3625		1.18	.63	1.73	2.17	.69	1.97	1.97	155.4	58.66			
42	250	M 48 x 2	36	17,5	47,5	59,5	19	55	60	260	33,79	FI-GE-42LM-OR-B-W3			
1.65	3625		1.42	.69	1.87	2.34	.75	2.17	2.36	192.4	74.34				
S	6	630	M 12 x 1,5	4	11	31	39	13	17	17	35	2,93	FI-GE-06SM-OR-B-W3		
	.24	9135		.16	.43	1.22	1.54	.51	.67	.67	25.9	6.44			
	8	630	M 14 x 1,5	5	11	33	41	15	19	19	40	4,22	FI-GE-08SM-OR-B-W3		
	.31	9135		.20	.43	1.30	1.61	.59	.75	.75	29.6	9.28			
	10	630	M 16 x 1,5	7	12,5	35	44	15	22	22	55	6,11	FI-GE-10SM-OR-B-W3		
	.39	9135		.28	.49	1.38	1.73	.59	.87	.87	40.7	13.43			
	12	630	M 18 x 1,5	8	14	38,5	47,5	17	24	24	70	3,41	FI-GE-12SM-OR-B-W3		
	.47	9135		.31	.55	1.52	1.87	.67	.94	.94	51.8	7.51			
	16	630	M 22 x 1,5	12	15	42	52	18,5	27	30	100	6,37	FI-GE-16SM-OR-B-W3		
	.63	9135		.47	.59	1.65	2.05	.73	1.06	1.18	74.0	14.01			
	20	400	M 27 x 2	15	18,5	49,5	60,5	20,5	32	36	170	16,88	FI-GE-20SM-OR-B-W3		
	.79	5800		.59	.73	1.95	2.38	.81	1.26	1.42	125.8	37.13			
	25	400	M 33 x 2	20	18,5	53,5	65,5	23	41	46	310	27,42	FI-GE-25SM-OR-B-W3		
	.98	5800		.79	.73	2.11	2.58	.91	1.61	1.81	229.4	60.33			
	30	400	M 42 x 2	25	19	56	69	23,5	50	50	330	42,45	FI-GE-30SM-OR-B-W3		
	1.18	5800		.98	.75	2.20	2.72	.93	1.97	1.97	244.2	93.39			
	38	400	M 48 x 2	32	21,5	63,5	78,5	26	55	60	420	58,60	FI-GE-38SM-OR-B-W3		
	1.50	5800		1.26	.85	2.50	3.09	1.02	2.17	2.36	310.8	128.92			

¹ Approximate dimension in assembled condition.

² Weight excluding cutting ring and union nut.

³ Standard scope of delivery: Fitting body only.

Male stud acc. to ISO 6149-2/-3

Port acc. to ISO 6149-1

Torque recommendations for Steel mating material.

Standard seal material is NBR (Buna-N®).



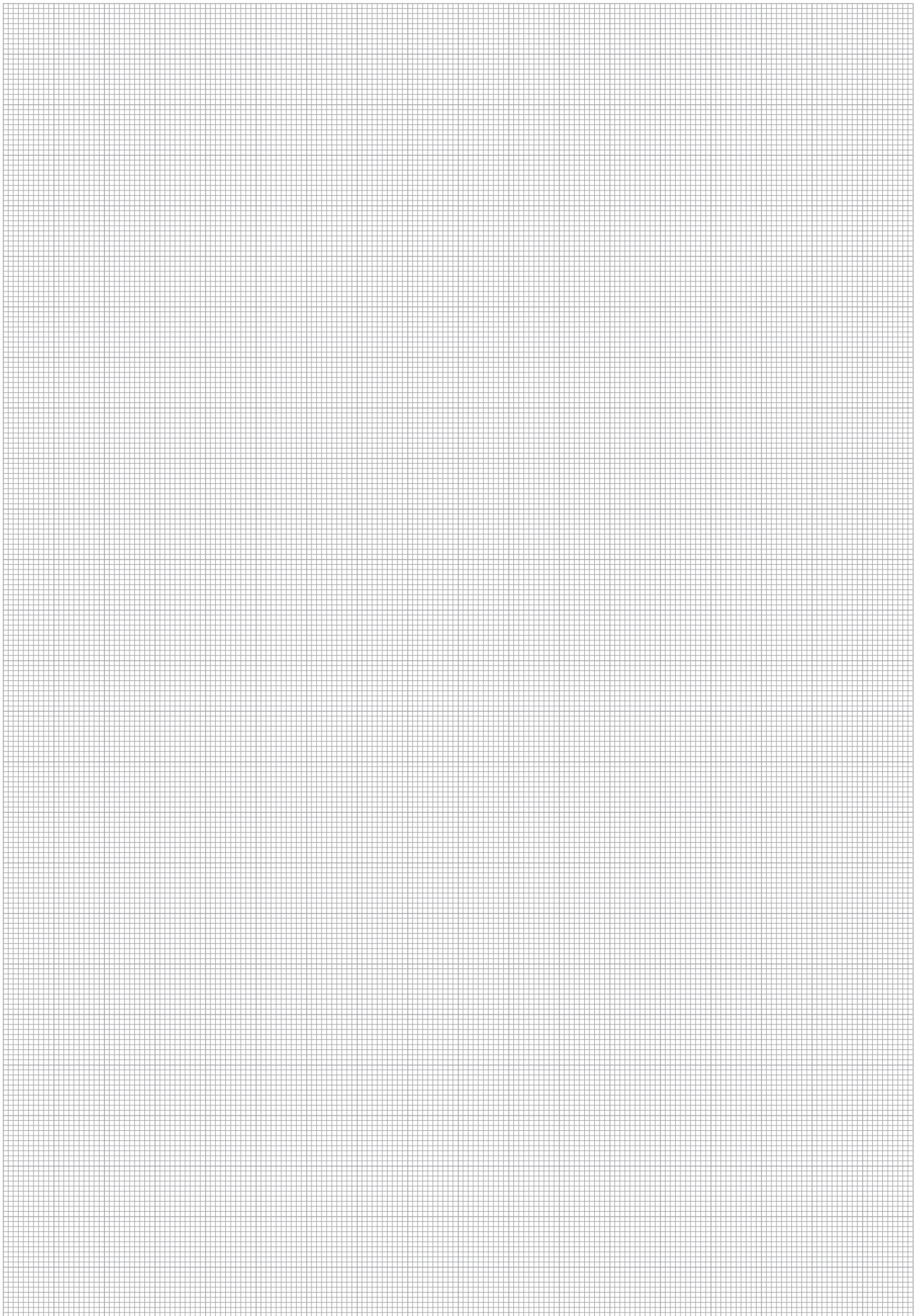

Straight Male Stud Fitting
Type FI-GE-...-Rk • Series LL / L

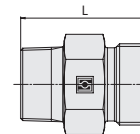
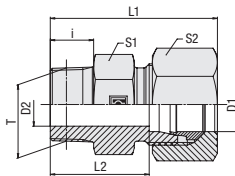

C

Whitworth Taper Pipe Thread (BSPT)

Ordering Codes

***FI-GE*-10*L*Rk*-W3*-MS**

- * Straight Male Stud Fitting **FI-GE**
- * Outside Tube Diameter D1 (in mm) **-10**
- * Series **LL**
 Extra-Light Series (page 54)
 Light Series (page 54)
 Heavy Series (page 55)
L
S
- * Thread Type **Rk**
 Whitworth Taper
 Pipe Thread (BSPT)
- If required, please indicate special sizes, e.g. R1/8k!
- * Material Code **-W3**
 Steel, zinc/nickel-plated
- Please contact STAUFF for alternative materials and surface finishings.
- * Assembling / Kitting **—**
 Fitting body only
 Fitting body supplied with cutting ring and union nut **-MS**
 Fitting body supplied with soft-sealing cutting ring and union nut **-MSV**

Connecting Parts

- Cutting Ring
Type **FI-DS** Page 26
- Soft-Sealing Cutting Ring
Type **FI-WDDS** Page 27
- Support Sleeve
Type **FI-VH** Page 28
- STAUFF Form Ring
Type **FI-AR** Page 30
- Union Nut
Type **FI-M** Page 31
- 37° Flared Tube Fitting Set
Type **FI-AB** Page 35

¹ Approximate dimension in assembled condition.

² Weight excluding cutting ring and union nut.

³ Standard scope of delivery: Fitting body only.

Male stud acc. to DIN 3852-2 (Form C)

Port acc. to DIN 3852-2 (Form Z)

Suitable liquid / plastic sealant required.

Series	Tube OD (mm/in)	PN (PB) (bar/psi)	Dimensions (mm/in)	Weight (kg/lbs) ca. per 100 ²	Ordering Codes ³	
	D1		Thread T D2 i L L1 ¹ L2 S1 S2			
LL	4	100	R 1/8 keg. 3 8 20 26 16 10 10	0,77	FI-GE-04LLRk-W3	
	.16	1450	.12 .31 .79 1.02 .63 .39 .39	1.70		
	6	100	R 1/8 keg. 4,5 8 20 26 14,5 11 12	0,79	FI-GE-06LLRk-W3	
	.24	1450	.18 .31 .79 1.02 .57 .43 .47	1.75		
	8	100	R 1/8 keg. 4,5 8 22 28 16,5 12 14	1,08	FI-GE-08LLRk-W3	
	.31	1450	.18 .31 .87 1.10 .65 .47 .55	2.38		
	8	100	R 1/4 keg. 6 12 26 32 20,5 14 14	1,71	FI-GE-08LLR1/4k-W3	
	.31	1450	.24 .47 1.02 1.26 .81 .55 .55	3.77		
	10	100	R 1/4 keg. 8 12 26 32 20,5 14 17	2,70	FI-GE-10LLRk-W3	
	.39	1450	.31 .47 1.02 1.26 .81 .55 .67	5.94		
	L	6	315	R 1/8 keg. 4 8 22 30 15 12 14	1,11	FI-GE-06LRk-W3
		.24	4568	.16 .31 .87 1.18 .59 .47 .55	2.43	
6		315	R 1/4 keg. 4 12 27 35 20 14 14	1,99	FI-GE-06LR1/4k-W3	
.24		4568	.16 .47 1.06 1.38 .79 .55 .55	4.37		
6		315	R 3/8 keg. 4 12 28 36 21 19 14	2,80	FI-GE-06LR3/8k-W3	
.24		4568	.16 .47 1.10 1.42 .83 .75 .55	6.17		
6		315	R 1/2 keg. 4 14 30 38 23 22 14	5,19	FI-GE-06LR1/2k-W3	
.24		4568	.16 .55 1.18 1.50 .91 .87 .55	11.42		
8		315	R 1/8 keg. 4 8 25 33 18 14 17	1,78	FI-GE-08LR1/8k-W3	
.31		4568	.16 .31 .98 1.30 .71 .55 .67	3.92		
8		315	R 1/4 keg. 6 12 27 35 20 14 17	1,88	FI-GE-08LRk-W3	
.31		4568	.24 .47 1.06 1.38 .79 .55 .67	4.13		
8		315	R 3/8 keg. 6 12 28 36 21 19 17	3,44	FI-GE-08LR3/8k-W3	
.31		4568	.24 .47 1.10 1.42 .83 .75 .67	7.58		
8		315	R 1/2 keg. 6 14 30 38 23 24 17	5,02	FI-GE-08LR1/2k-W3	
.31		4568	.24 .55 1.18 1.50 .91 .94 .67	11.04		
10		315	R 1/8 keg. 4 8 24 32 17 17 19	1,97	FI-GE-10LR1/8k-W3	
.39		4568	.16 .31 .94 1.26 .67 .67 .75	4.33		
10		315	R 1/4 keg. 7 12 28 36 21 17 19	2,28	FI-GE-10LRk-W3	
.39		4568	.28 .47 1.10 1.42 .83 .67 .75	5.02		
10		315	R 3/8 keg. 8 12 29 37 22 19 19	3,13	FI-GE-10LR3/8k-W3	
.39		4568	.31 .47 1.14 1.46 .87 .75 .75	6.88		
10		315	R 1/2 keg. 8 14 30 38 23 24 19	1,22	FI-GE-10LR1/2k-W3	
.39		4568	.31 .55 1.18 1.50 .91 .94 .75	2.69		
12		315	R 1/4 keg. 6 12 29 37 22 19 22	2,69	FI-GE-12LR1/4k-W3	
.47		4568	.24 .47 1.14 1.46 .87 .75 .87	6.67		
12		315	R 3/8 keg. 9 12 29 37 22 19 22	3,28	FI-GE-12LRk-W3	
.47		4568	.35 .47 1.14 1.46 .87 .75 .87	7.22		
12		315	R 1/2 keg. 10 14 31 39 24 22 22	5,02	FI-GE-12LR1/2k-W3	
.47		4568	.39 .55 1.22 1.54 .94 .87 .87	11.03		
15		315	R 3/8 keg. 9 12 30 38 23 24 27	5,06	FI-GE-15LR3/8k-W3	
.59		4568	.35 .47 1.18 1.50 .91 .94 1.06	11.13		
15		315	R 1/2 keg. 12 14 32 40 25 24 27	5,35	FI-GE-15LRk-W3	
.59		4568	.47 .55 1.26 1.57 .98 .94 1.06	11.76		
15		160	R 3/4 keg. 12 17 36 44 29 27 27	16,48	FI-GE-15LR3/4k-W3	
.59		2320	.47 .67 1.42 1.73 1.14 1.06 1.06	36.26		
18	315	R 1/2 keg. 14 14 33 42 25 27 32	6,42	FI-GE-18LRk-W3		
.71	4568	.55 .55 1.30 1.65 1.00 1.06 1.26	14.13			
22	PB160	R 1/2 keg. 12 14 38 47 30 32 36	10,20	FI-GE-22LR1/2k-W3		
.87	PB2320	.47 .55 1.50 1.85 1.20 1.26 1.42	22.43			
22	PB160	R 3/4 keg. 17 17 37 46 29 32 36	8,91	FI-GE-22LRk-W3		
.87	PB2320	.67 .67 1.46 1.81 1.16 1.26 1.42	19.61			
28	PB160	R 3/4 keg. 18 16 38 47 31 31 41	14,59	FI-GE-28LR3/4k-W3		
1.10	PB2320	.71 .63 1.50 1.85 1.24 1.61 1.61	32.10			
28	PB160	R 1 keg. 23 18 42 51 34 41 41	16,49	FI-GE-28LRk-W3		
1.10	PB2320	.91 .71 1.65 2.01 1.36 1.61 1.61	36.28			
35	PB160	R 1 1/4 keg. 30 20 45 56 34 46 50	23,73	FI-GE-35LRk-W3		
1.38	PB2320	1.18 .79 1.77 2.20 1.36 1.81 1.97	52.21			
42	PB160	R 1 1/2 keg. 36 22 49 61 38 55 60	33,09	FI-GE-42LRk-W3		
1.65	PB2320	1.42 .87 1.93 2.40 1.50 2.17 2.36	72.81			



**Straight Male Stud Fitting
Type FI-GE-...-Rk • Series S**

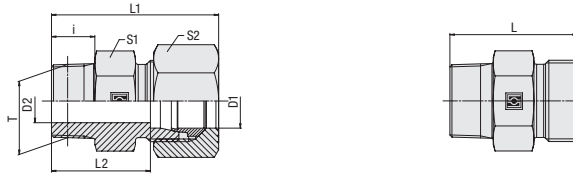

Whitworth Taper Pipe Thread (BSPT)

Series	Tube OD (mm/in)	PB (bar/PSI)	Dimensions (mm/in)								Weight (kg/lbs) ca. per 100 ²	Ordering Codes ³
			Thread	T	D2	i	L	L1 ¹	L2	S1		
S	6	630	R 1/4 keg.	4	12	30	38	23	17	17	3,01	FI-GE-06SRk-W3
	.24	9135		.16	.47	1.18	1.50	.91	.67	.67	6.62	
	8	630	R 1/4 keg.	5	12	29	37	22	17	19	3,50	FI-GE-08SRk-W3
	.31	9135		.20	.47	1.14	1.46	.87	.67	.75	7.69	
	10	630	R 3/8 keg.	7	12	32	41	24,5	19	22	4,49	FI-GE-10SRk-W3
	.39	9135		.28	.47	1.26	1.61	.96	.75	.87	9.88	
	12	630	R 3/8 keg.	8	12	34	43	26,5	22	24	6,03	FI-GE-12SRk-W3
	.47	9135		.31	.47	1.34	1.69	1.04	.87	.94	13.27	
	14	630	R 1/2 keg.	10	14	35	45	27	24	27	7,04	FI-GE-14SRk-W3
	.55	9135		.39	.55	1.38	1.77	1.06	.94	1.06	15.48	
	16	400	R 1/2 keg.	12	14	38	48	29,5	27	30	8,52	FI-GE-16SRk-W3
	.63	5800		.47	.55	1.50	1.89	1.16	1.06	1.18	18.75	
	20	400	R 3/4 keg.	16	17	45,5	57	35	32	36	14,43	FI-GE-20SRk-W3
	.79	5800		.63	.67	1.79	2.24	1.38	1.26	1.42	31.75	

¹ Approximate dimension in assembled condition.

² Weight excluding cutting ring and union nut.

³ Standard scope of delivery: Fitting body only.

Male stud acc. to DIN 3852-2 (Form C)

Port acc. to DIN 3852-2 (Form Z)

Suitable liquid / plastic sealant required.

Ordering Codes

***FI-GE*-10*L*Rk*-W3*-MS**

* Straight Male Stud Fitting	FI-GE
* Outside Tube Diameter D1 (in mm)	-10
* Series	Extra-Light Series (page 54) LL Light Series (page 54) L Heavy Series (page 55) S
* Thread Type	Whitworth Taper Pipe Thread (BSPT) Rk
If required, please indicate special sizes, e.g. R1/8k!	
* Material Code	Steel, zinc/nickel-plated -W3
Please contact STAUFF for alternative materials and surface finishings.	
* Assembling / Kitting	Fitting body only —
	Fitting body supplied with cutting ring and union nut -MS
	Fitting body supplied with soft-sealing cutting ring and union nut -MSV

Connecting Parts

	Cutting Ring Type FI-DS	Page 26
	Soft-Sealing Cutting Ring Type FI-WDDS	Page 27
	Support Sleeve Type FI-VH	Page 28
	STAUFF Form Ring Type FI-AR	Page 30
	Union Nut Type FI-M	Page 31
	37° Flared Tube Fitting Set Type FI-AB	Page 35



Straight Male Stud Fitting
Type FI-GE-...-Mk ▪ Series LL / L

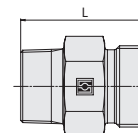
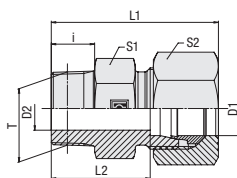

C

Metric Taper Thread

Ordering Codes

***FI-GE*-10*L*Mk*-W3*-MS**

- * Straight Male Stud Fitting **FI-GE**
- * Outside Tube Diameter D1 (in mm) **-10**
- * Series **LL**
Extra-Light Series
Light Series **L**
- * Thread Type **Mk**
Metric Taper Thread
- If required, please indicate special sizes, e.g. M16x1.5k!
- * Material Code **-W3**
Steel, zinc/nickel-plated
- Please contact STAUFF for alternative materials and surface finishings.
- * Assembling / Kitting **—**
Fitting body only
- Fitting body supplied with cutting ring and union nut **-MS**
- Fitting body supplied with soft-sealing cutting ring and union nut **-MSV**

Connecting Parts

- Cutting Ring
Type **FI-DS** Page 26
- Soft-Sealing Cutting Ring
Type **FI-WDDS** Page 27
- Support Sleeve
Type **FI-VH** Page 28
- STAUFF Form Ring
Type **FI-AR** Page 30
- Union Nut
Type **FI-M** Page 31
- 37° Flared Tube Fitting Set
Type **FI-AB** Page 35

Series	Tube OD (mm/in)	PN (bar/psi)	Dimensions (mm/in)									Weight (kg/lbs) ca. per 100 ²	Ordering Codes ³
			Thread	T	D2	i	L	L1 ¹	L2	S1	S2		
LL	4	100	M 6 x 1 keg.	2,5	8	20	26	16	9	10	0,50	FI-GE-04LLM6x1k-W3	
	.16	1450		.10	.31	.79	1.02	.63	.35	.39	1.09		
	4	100	M 8 x 1 keg.	3	8	20	26	16	10	10	0,63	FI-GE-04LLMk-W3	
	.16	1450		.12	.31	.79	1.02	.63	.39	.39	1.39		
	4	100	M 10 x 1 keg.	3	8	20	26	16	11	10	0,85	FI-GE-04LLM10x1k-W3	
	.16	1450		.12	.31	.79	1.02	.63	.43	.39	1.87		
	6	100	M 6 x 1 keg.	2	8	20	26	14,5	11	12	0,68	FI-GE-06LLM6x1k-W3	
	.24	1450		.08	.31	.79	1.02	.57	.43	.47	1.50		
	6	100	M 8 x 1 keg.	3	8	20	26	14,5	11	12	0,75	FI-GE-06LLM8x1k-W3	
	.24	1450		.12	.31	.79	1.02	.57	.43	.47	1.66		
	6	100	M 10 x 1 keg.	4	8	20	26	14,5	11	12	0,85	FI-GE-06LLMk-W3	
	.24	1450		.16	.31	.79	1.02	.57	.43	.47	1.88		
8	100	M 8 x 1 keg.	3,5	8	22	28	16,5	12	14	1,29	FI-GE-08LLM8x1k-W3		
.31	1450		.14	.31	.87	1.10	.65	.47	.55	2.83			
8	100	M 10 x 1 keg.	6	8	22	28	16,5	12	14	0,98	FI-GE-08LLMk-W3		
.31	1450		.24	.31	.87	1.10	.65	.47	.55	2.15			
L	6	315	M 10 x 1 keg.	4	8	23	31	16	14	14	2,12	FI-GE-06LMk-W3	
	.24	4568		.16	.31	.91	1.22	.63	.55	.55	4.67		
	6	315	M 12 x 1,5 keg.	4	12	27	35	20	14	14	2,26	FI-GE-06LM12x1.5k-W3	
	.24	4568		.16	.47	1.06	1.38	.79	.55	.55	4.98		
	8	315	M 12 x 1,5 keg.	6	12	27	35	20	14	17	1,74	FI-GE-08LMk-W3	
	.31	4568		.24	.47	1.06	1.38	.79	.55	.67	3.83		
	8	315	M 14 x 1,5 keg.	6	12	27	35	20	17	17	3,11	FI-GE-08LM14x1.5k-W3	
	.31	4568		.24	.47	1.06	1.38	.79	.67	.67	6.83		
	10	315	M 14 x 1,5 keg.	7	12	28	36	21	17	19	2,51	FI-GE-10LMk-W3	
	.39	4568		.28	.47	1.10	1.42	.83	.67	.75	5.53		
	10	315	M 16 x 1,5 keg.	8	12	28	36	21	17	19	4,05	FI-GE-10LM16x1.5k-W3	
	.39	4568		.31	.47	1.10	1.42	.83	.67	.75	8.91		
	12	315	M 16 x 1,5 keg.	9	12	29	37	22	19	22	3,18	FI-GE-12LMk-W3	
	.47	4568		.35	.47	1.14	1.46	.87	.75	.87	6.99		
	12	315	M 18 x 1,5 keg.	10	12	29	37	22	19	22	4,90	FI-GE-12LM18x1.5k-W3	
	.47	4568		.39	.47	1.14	1.46	.87	.75	.87	10.78		
	15	315	M 18 x 1,5 keg.	11	12	30	41	23	24	27	4,73	FI-GE-15LMk-W3	
	.59	4568		.43	.47	1.18	1.61	.91	.94	1.06	10.41		
18	315	M 22 x 1,5 keg.	14	14	33	42	25,5	27	32	7,02	FI-GE-18LMk-W3		
.71	4568		.55	.55	1.30	1.65	1.00	1.06	1.26	15.44			

¹ Approximate dimension in assembled condition.

² Weight excluding cutting ring and union nut.

³ Standard scope of delivery: Fitting body only.

Male stud acc. to DIN 3852-1 (Form C)

Port acc. to DIN 3852-1 (Form Z)

Suitable liquid / plastic sealant required.



Straight Male Stud Fitting
Type FI-GE*...-N • Series LL / L

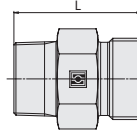
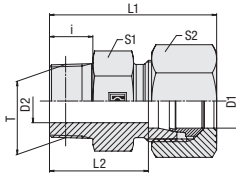

NPT Thread

Series	Tube OD		PN (bar/PSI)	Dimensions (mm/in)								Weight (kg/lbs) ca. per 100 ²	Ordering Codes ³
	D1	D2		Thread	T	D2	i	L	L1 ¹	L2	S1		
LL	4	100	1/8 NPT	3	10	22	28	18	11	10	0,98	FI-GE-04LL1/8N-W3	
	.16	1450		.12	.39	.87	1.10	.71	.43	.39	2.15		
	6	100	1/8 NPT	4,5	10	22	28	16,5	11	12	0,90	FI-GE-06LL1/8N-W3	
	.24	1450		.18	.39	.87	1.10	.65	.43	.47	1.97		
8	100	1/8 NPT	5	10	24	30	18,5	12	14	1,16	FI-GE-08LL1/8N-W3		
.31	1450		.20	.39	.94	1.18	.73	.47	.55	2.55			
L	6	315	1/8 NPT	4	10	24	32	17	12	14	1,21	FI-GE-06L1/8N-W3	
	.24	4568		.16	.39	.94	1.26	.67	.47	.55	2.66		
	6	315	1/4 NPT	4	15,5	30	38	23	17	14	2,63	FI-GE-06L1/4N-W3	
	.24	4568		.16	.61	1.18	1.50	.91	.67	.55	5.79		
	6	315	3/8 NPT	4	15,5	31	39	24	19	14	4,01	FI-GE-06L3/8N-W3	
	.24	4568		.16	.61	1.22	1.54	.94	.75	.55	8.82		
	6	315	1/2 NPT	4	20	36	44	29	22	14	5,62	FI-GE-06L1/2N-W3	
	.24	4568		.16	.79	1.42	1.73	1.14	.87	.55	12.37		
	8	315	1/8 NPT	4	10	25	33	18	14	17	1,65	FI-GE-08L1/8N-W3	
	.31	4568		.16	.39	.98	1.30	.71	.55	.67	3.63		
	8	315	1/4 NPT	6	15	30	38	23	17	17	2,49	FI-GE-08L1/4N-W3	
	.31	4568		.24	.59	1.18	1.50	.91	.67	.67	5.48		
	8	315	3/8 NPT	6	15,5	30	38	23	19	17	3,70	FI-GE-08L3/8N-W3	
	.31	4568		.24	.61	1.18	1.50	.91	.75	.67	8.14		
	8	315	1/2 NPT	6	20	36	44	29	22	17	6,78	FI-GE-08L1/2N-W3	
	.31	4568		.24	.79	1.42	1.73	1.14	.87	.67	14.91		
	10	315	1/8 NPT	4	10	25	33	18	17	19	1,90	FI-GE-10L1/8N-W3	
	.39	4568		.16	.39	.98	1.30	.71	.67	.75	4.18		
	10	315	1/4 NPT	7	15	31	39	24	17	19	2,53	FI-GE-10L1/4N-W3	
	.39	4568		.28	.59	1.22	1.54	.94	.67	.75	5.57		
	10	315	3/8 NPT	7	15	32	40	25	19	19	3,97	FI-GE-10L3/8N-W3	
	.39	4568		.28	.59	1.26	1.57	.98	.75	.75	8.73		
	10	315	1/2 NPT	7	20	37	45	30	22	19	6,99	FI-GE-10L1/2N-W3	
	.39	4568		.28	.79	1.46	1.77	1.18	.87	.75	15.39		
	10	315	3/4 NPT	8	20	38	46	31	27	19	5,67	FI-GE-10L3/4N-W3	
	.39	4568		.31	.79	1.50	1.81	1.22	1.06	.75	12.47		
	12	315	1/8 NPT	4	10	26	34	19	19	22	2,48	FI-GE-12L1/8N-W3	
	.47	4568		.16	.39	1.02	1.34	.75	.75	.87	5.45		
	12	315	1/4 NPT	7	15	32	40	25	19	22	3,21	FI-GE-12L1/4N-W3	
	.47	4568		.28	.59	1.26	1.57	.98	.75	.87	7.05		
	12	315	3/8 NPT	8	15	32	40	25	19	22	3,95	FI-GE-12L3/8N-W3	
	.47	4568		.31	.59	1.26	1.57	.98	.75	.87	8.69		
12	315	1/2 NPT	10	20	37	45	30	24	22	6,48	FI-GE-12L1/2N-W3		
.47	4568		.39	.79	1.46	1.77	1.18	.94	.87	14.25			
12	315	3/4 NPT	8	20	38	46	31	27	22	10,93	FI-GE-12L3/4N-W3		
.47	4568		.31	.79	1.50	1.81	1.22	1.06	.87	24.04			
15	315	1/4 NPT	7	15,5	33	41	26	24	27	4,72	FI-GE-15L1/4N-W3		
.59	4568		.28	.61	1.30	1.61	1.02	.94	1.06	10.38			
15	315	3/8 NPT	11	15,5	38	46	31	24	27	5,12	FI-GE-15L3/8N-W3		
.59	4568		.43	.61	1.50	1.81	1.22	.94	1.06	11.26			
15	315	1/2 NPT	12	20	38	46	31	24	27	6,44	FI-GE-15L1/2N-W3		
.59	4568		.47	.79	1.50	1.81	1.22	.94	1.06	14.16			
15	315	3/4 NPT	12	20	40	48	33	27	27	10,60	FI-GE-15L3/4N-W3		
.59	4568		.47	.79	1.57	1.89	1.30	1.06	1.06	23.31			

Ordering Codes

***FI-GE*-10*L*1/4*N*-W3*-MS**

- * Straight Male Stud Fitting **FI-GE**
- * Outside Tube Diameter D1 (in mm) **-10**
- * Series Extra-Light Series (page 57) **LL**
Light Series (pages 57/58) **L**
Heavy Series (page 59) **S**
- * Thread Size acc. to dimension table **1/4**
- Please always indicate thread sizes, e.g. 1/4!
- * Thread Type NPT Thread **N**
- * Material Code Steel, zinc/nickel-plated **-W3**
- Please contact STAUFF for alternative materials and surface finishings.
- * Assembling / Kitting Fitting body only **—**
- Fitting body supplied with cutting ring and union nut **-MS**
- Fitting body supplied with soft-sealing cutting ring and union nut **-MSV**

Connecting Parts

- Cutting Ring Type **FI-DS** Page 26
- Soft-Sealing Cutting Ring Type **FI-WDDS** Page 27
- Support Sleeve Type **FI-VH** Page 28
- STAUFF Form Ring Type **FI-AR** Page 30
- Union Nut Type **FI-M** Page 31
- 37° Flared Tube Fitting Set Type **FI-AB** Page 35

¹ Approximate dimension in assembled condition.
² Weight excluding cutting ring and union nut.
³ Standard scope of delivery: Fitting body only.

Male stud acc. to ANSI/ASME B1.20.1-1983
 Port acc. to ANSI/ASME B1.20.1-1983

Suitable liquid / plastic sealant required.



Straight Male Stud Fitting
Type FI-GE-...-N ▪ Series L

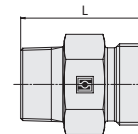
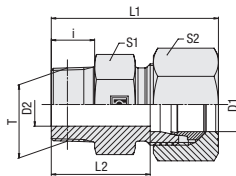

C

NPT Thread

Ordering Codes

***FI-GE*-10*L*1/4*N*-W3*-MS**

- * Straight Male Stud Fitting **FI-GE**
- * Outside Tube Diameter D1 (in mm) **-10**
- * Series **LL** Extra-Light Series (page 57)
L Light Series (pages 57/58)
S Heavy Series (page 59)
- * Thread Size **1/4** acc. to dimension table
Please always indicate thread sizes, e.g. 1/4!
- * Thread Type **N** NPT Thread
- * Material Code **-W3** Steel, zinc/nickel-plated
Please contact STAUFF for alternative materials and surface finishings.
- * Assembling / Kitting **—** Fitting body only
-MS Fitting body supplied with cutting ring and union nut
-MSV Fitting body supplied with soft-sealing cutting ring and union nut

Series	Tube OD (mm/in)	PN (bar/psi)	Dimensions (mm/in)								Weight (kg/lbs) ca. per 100 ²	Ordering Codes ³
			Thread	T	D2	i	L	L1 ¹	L2	S1		
L	18	315	3/8 NPT	8	15,5	34	43	26,5	27	32	6,78	FI-GE-18L3/8N-W3
	.71	4568		.31	.61	1.34	1.69	1.04	1.06	1.26	14.92	
	18	315	1/2 NPT	12	20	39	48	31,5	27	32	8,10	FI-GE-18L1/2N-W3
	.71	4568		.47	.79	1.54	1.89	1.24	1.06	1.26	17.82	
	18	315	3/4 NPT	15	20	39	48	31,5	27	32	10,51	FI-GE-18L3/4N-W3
	.71	4568		.59	.79	1.54	1.89	1.24	1.06	1.26	23.12	
	18	315	1 NPT	15	25	45	54	37,5	36	32	16,85	FI-GE-18L1N-W3
	.71	4568		.59	.98	1.77	2.13	1.48	1.42	1.26	37.08	
	22	160	1/2 NPT	14	20	41	50	33,5	32	36	9,26	FI-GE-22L1/2N-W3
	.87	2320		.55	.79	1.61	1.97	1.32	1.26	1.42	20.37	
	22	160	3/4 NPT	16	20	41	50	33,5	32	36	11,07	FI-GE-22L3/4N-W3
	.87	2320		.63	.79	1.61	1.97	1.32	1.26	1.42	24.35	
	22	160	1 NPT	19	25	47	56	39,5	36	36	18,05	FI-GE-22L1N-W3
	.87	2320		.75	.98	1.85	2.20	1.56	1.42	1.42	39.70	
	28	160	3/4 NPT	18	20	42	51	34,5	41	41	18,00	FI-GE-28L3/4N-W3
	1.10	2320		.71	.79	1.65	2.01	1.36	1.61	1.61	39.60	
	28	160	1 NPT	21	25	47	56	39,5	41	41	19,89	FI-GE-28L1N-W3
	1.10	2320		.83	.98	1.85	2.20	1.56	1.61	1.61	43.76	
	28	160	1 1/4 NPT	24	26	49	58	41,5	46	41	27,00	FI-GE-28L1-1/4N-W3
	1.10	2320		.94	1.02	1.93	2.28	1.63	1.81	1.61	59.40	
	35	160	1 1/4 NPT	28	26	51	62	40,5	46	50	39,59	FI-GE-35L1-1/4N-W3
	1.38	2320		1.10	1.02	2.01	2.44	1.59	1.81	1.97	87.09	
	42	160	1 1/4 NPT	28	26	53	65	42	55	60	35,36	FI-GE-42L1-1/4N-W3
	1.65	2320		1.10	1.02	2.09	2.56	1.65	2.17	2.36	77.79	
42	160	1 1/2 NPT	36	26	53	65	42	55	60	35,36	FI-GE-42L1-1/2N-W3	
1.65	2320		1.42	1.02	2.09	2.56	1.65	2.17	2.36	77.79		

Connecting Parts

- Cutting Ring
Type **FI-DS** Page 26
- Soft-Sealing Cutting Ring
Type **FI-WDDS** Page 27
- Support Sleeve
Type **FI-VH** Page 28
- STAUFF Form Ring
Type **FI-AR** Page 30
- Union Nut
Type **FI-M** Page 31
- 37° Flared Tube Fitting Set
Type **FI-AB** Page 35

¹ Approximate dimension in assembled condition.
² Weight excluding cutting ring and union nut.
³ Standard scope of delivery: Fitting body only.

Male stud acc. to ANSI/ASME B1.20.1-1983
Port acc. to ANSI/ASME B1.20.1-1983

Suitable liquid / plastic sealant required.



Straight Male Stud Fitting
Type FI-GE-...-N • Series S

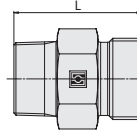
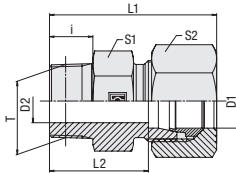

NPT Thread

Series	Tube OD (mm/in)	PN (bar/psi)	Dimensions (mm/in)									Weight (kg/lbs) ca. per 100 ²	Ordering Codes ³
			Thread	T	D2	i	L	L1 ¹	L2	S1	S2		
S	6	630	1/8 NPT	4	10	28	36	21	14	17	2,30	FI-GE-06S1/8N-W3	
	.24	9135		.16	.39	1.10	1.42	.83	.55	.67	5.06		
6	630		1/4 NPT	4	15	35	43	28	17	17	3,71	FI-GE-06S1/4N-W3	
	.24	9135		.16	.59	1.38	1.69	1.10	.67	.67	8.17		
6	630		3/8 NPT	4	15,5	33	41	26	19	17	4,50	FI-GE-06S3/8N-W3	
	.24	9135		.16	.61	1.30	1.61	1.02	.75	.67	9.91		
8	630		1/8 NPT	4	10	29,5	37,5	22,5	17	19	3,20	FI-GE-08S1/8N-W3	
	.31	9135		.16	.39	1.16	1.48	.89	.67	.75	7.04		
8	630		1/4 NPT	5	15	35	43	28	17	19	3,81	FI-GE-08S1/4N-W3	
	.31	9135		.20	.59	1.38	1.69	1.10	.67	.75	8.37		
8	630		3/8 NPT	5	15,5	36	44	29	19	19	5,31	FI-GE-08S3/8N-W3	
	.31	9135		.20	.61	1.42	1.73	1.14	.75	.75	11.68		
8	630		1/2 NPT	5	20	40	48	33	22	19	8,17	FI-GE-08S1/2N-W3	
	.31	9135		.20	.79	1.57	1.89	1.30	.87	.75	17.97		
10	630		1/4 NPT	5	15	35	44	27,5	19	22	4,36	FI-GE-10S1/4N-W3	
	.39	9135		.20	.59	1.38	1.73	1.08	.75	.87	9.59		
10	630		3/8 NPT	7	15	35	44	27,5	19	22	4,95	FI-GE-10S3/8N-W3	
	.39	9135		.28	.59	1.38	1.73	1.08	.75	.87	10.89		
10	630		1/2 NPT	7	20	38	47	30,5	22	22	7,32	FI-GE-10S1/2N-W3	
	.39	9135		.28	.79	1.50	1.85	1.20	.87	.87	16.11		
12	630		1/4 NPT	5	15,5	37	46	29,5	22	24	4,84	FI-GE-12S1/4N-W3	
	.47	9135		.20	.61	1.46	1.81	1.16	.87	.94	10.66		
12	630		3/8 NPT	8	15	37	46	29,5	22	24	6,21	FI-GE-12S3/8N-W3	
	.47	9135		.31	.59	1.46	1.81	1.16	.87	.94	13.67		
12	630		1/2 NPT	8	20	42	51	34,5	22	24	8,52	FI-GE-12S1/2N-W3	
	.47	9135		.31	.79	1.65	2.01	1.36	.87	.94	18.74		
12	630		3/4 NPT	8	20	44	53	36,5	30	24	12,38	FI-GE-12S3/4N-W3	
	.47	9135		.31	.79	1.73	2.09	1.44	1.18	.94	27.23		
14	630		3/8 NPT	8	15,5	39	49	31	24	27	7,32	FI-GE-14S3/8N-W3	
	.55	9135		.31	.61	1.54	1.93	1.22	.94	1.06	16.11		
14	630		1/2 NPT	10	20	44	54	36	24	27	6,76	FI-GE-14S1/2N-W3	
	.55	9135		.39	.79	1.73	2.13	1.42	.94	1.06	14.88		
16	400		3/8 NPT	8	15	39	49	30,5	27	30	8,66	FI-GE-16S3/8N-W3	
	.63	5800		.31	.59	1.54	1.93	1.20	1.06	1.18	19.06		
16	400		1/2 NPT	12	20	44	54	35,5	27	30	4,42	FI-GE-16S1/2N-W3	
	.63	5800		.47	.79	1.73	2.13	1.40	1.06	1.18	9.72		
16	400		3/4 NPT	12	20	45	55	36,5	30	30	13,97	FI-GE-16S3/4N-W3	
	.63	5800		.47	.79	1.77	2.17	1.44	1.18	1.18	30.73		
20	400		1/2 NPT	12	20	48	59	37,5	32	36	12,18	FI-GE-20S1/2N-W3	
	.79	5800		.47	.79	1.89	2.32	1.48	1.26	1.42	26.80		
20	400		3/4 NPT	16	22	48	59	37,5	32	36	15,05	FI-GE-20S3/4N-W3	
	.79	5800		.63	.87	1.89	2.32	1.48	1.26	1.42	33.12		
20	400		1 NPT	16	25	55	66	44,5	36	36	25,37	FI-GE-20S1N-W3	
	.79	5800		.63	.98	2.17	2.60	1.75	1.42	1.42	55.81		
25	400		1/2 NPT	20	25	57	59	45	41	46	30,60	FI-GE-25S1/2N-W3	
	.98	5800		.79	.98	2.24	2.32	1.77	1.61	1.81	67.32		
25	400		3/4 NPT	16	20	52	64	40	41	46	23,86	FI-GE-25S3/4N-W3	
	.98	5800		.63	.79	2.05	2.52	1.57	1.61	1.81	52.48		
25	400		1 NPT	20	25	57	69	45	41	46	28,19	FI-GE-25S1N-W3	
	.98	5800		.79	.98	2.24	2.72	1.77	1.61	1.81	62.01		
25	400		1 1/4 NPT	20	26	58	70	46	46	46	47,00	FI-GE-25S1-1/4N-W3	
	.98	5800		.79	1.02	2.28	2.76	1.81	1.81	1.81	103.40		
30	400		1 NPT	20	25	59	72	45,5	46	50	34,70	FI-GE-30S1N-W3	
	1.18	5800		.79	.98	2.32	2.83	1.79	1.81	1.97	76.34		
30	400		1 1/4 NPT	25	26	60	73	46,5	46	50	36,50	FI-GE-30S1-1/4N-W3	
	1.18	5800		.98	1.02	2.36	2.87	1.83	1.81	1.97	80.30		
30	400		1 1/2 NPT	25	26	60	73	46,5	50	50	36,50	FI-GE-30S1-1/2N-W3	
	1.18	5800		.98	1.02	2.36	2.87	1.83	1.97	1.97	80.30		
38	315		1 1/4 NPT	25	26	65	80	49	55	60	50,70	FI-GE-38S1-1/4N-W3	
	1.50	4568		.98	1.02	2.56	3.15	1.93	2.17	2.36	111.54		
38	315		1 1/2 NPT	32	26	65	80	49	55	60	50,70	FI-GE-38S1-1/2N-W3	
	1.50	4568		1.26	1.02	2.56	3.15	1.93	2.17	2.36	111.54		

Ordering Codes

***FI-GE*-10*L*1/4*N*-W3*-MS**

- * Straight Male Stud Fitting **FI-GE**
- * Outside Tube Diameter D1 (in mm) **-10**
- * Series Extra-Light Series (page 57) **LL**
Light Series (pages 57/58) **L**
Heavy Series (page 59) **S**
- * Thread Size acc. to dimension table **1/4**
- Please always indicate thread sizes, e.g. 1/4!
- * Thread Type NPT Thread **N**
- * Material Code Steel, zinc/nickel-plated **-W3**
- Please contact STAUFF for alternative materials and surface finishings.
- * Assembling / Kitting Fitting body only **—**
- Fitting body supplied with cutting ring and union nut **-MS**
- Fitting body supplied with soft-sealing cutting ring and union nut **-MSV**

Connecting Parts

- Cutting Ring Type **FI-DS** Page 26
- Soft-Sealing Cutting Ring Type **FI-WDDS** Page 27
- Support Sleeve Type **FI-VH** Page 28
- STAUFF Form Ring Type **FI-AR** Page 30
- Union Nut Type **FI-M** Page 31
- 37° Flared Tube Fitting Set Type **FI-AB** Page 35

¹ Approximate dimension in assembled condition.
² Weight excluding cutting ring and union nut.
³ Standard scope of delivery: Fitting body only.

Male stud acc. to ANSI/ASME B1.20.1-1983
 Port acc. to ANSI/ASME B1.20.1-1983

Suitable liquid / plastic sealant required.



**Straight Male Stud Fitting
Type FI-GE-...-U • Series L**

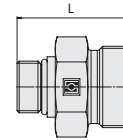
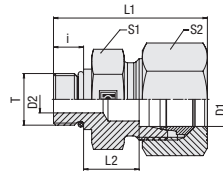

C

Ordering Codes

***FI-GE*-10*L*3/4*U*-B*-W3*-MS**

- * Straight Male Stud Fitting **FI-GE**
- * Outside Tube Diameter D1 (in mm) **-10**
- * Series Light Series (page 60) **L**
Heavy Series (page 61) **S**
- * Thread Size acc. to dimension table **3/4**
- Please always indicate thread sizes, e.g. 3/4!
- * Thread Type UN/UNF Thread with O-Ring **U**
- * Seal Material NBR (Buna-N®) **-B**
FKM (Viton®) **-V**
EPDM **-E**
- * Material Code Steel, zinc/nickel-plated **-W3**
- Please contact STAUFF for alternative materials and surface finishings.
- * Assembling / Kitting Fitting body only **—**
Fitting body supplied with cutting ring and union nut **-MS**
Fitting body supplied with soft-sealing cutting ring and union nut **-MSV**

Connecting Parts

-  Cutting Ring Type **FI-DS** Page 26
-  Soft-Sealing Cutting Ring Type **FI-WDDS** Page 27
-  Support Sleeve Type **FI-VH** Page 28
-  STAUFF Form Ring Type **FI-AR** Page 30
-  Union Nut Type **FI-M** Page 31
-  37° Flared Tube Fitting Set Type **FI-AB** Page 35

Spare Parts / Accessories

-  O-Ring Type **O-RING** Page 207

UN/UNF Thread

O-Ring

Series	Tube OD (mm/in)	PN (bar/psi)	Dimensions (mm/in)										Torque (N·m/lb·ft)	Weight (kg/lbs) ca. per 100 ²	Ordering Codes ³
			D1	Thread T	D2	i	L	L1 ¹	L2	S1	S2	Thread T			
L	6	400	7/16-20 UNF	4	9	26	34	10	17	14	18	2,08	FI-GE-06L7/16U-B-W3		
	.24	5800		.16	.35	1.02	1.34	.39	.67	.55	13.3	4.57			
	6	400	9/16-18 UNF	4	10	27	35	10	19	14	30	2,47	FI-GE-06L9/16U-B-W3		
	.24	5800		.16	.39	1.06	1.38	.39	.75	.55	22.2	5.44			
	8	400	7/16-20 UNF	6	9	26	34	10	17	17	18	2,18	FI-GE-08L7/16U-B-W3		
	.31	5800		.24	.35	1.02	1.34	.39	.67	.67	13.3	4.79			
	8	400	9/16-18 UNF	6	10	27	35	10	19	17	30	2,76	FI-GE-08L9/16U-B-W3		
	.31	5800		.24	.39	1.06	1.38	.39	.75	.67	22.2	6.06			
	10	400	7/16-20 UNF	4	9	27	35	11	17	19	18	2,17	FI-GE-10L7/16U-B-W3		
	.39	5800		.16	.35	1.06	1.38	.43	.67	.75	13.3	4.78			
	10	400	9/16-18 UNF	7	10	28	36	11	19	19	30	2,70	FI-GE-10L9/16U-B-W3		
	.39	5800		.28	.39	1.10	1.42	.43	.75	.75	22.2	5.94			
	10	400	3/4-16 UNF	8	11	31	39	13	24	19	50	5,21	FI-GE-10L3/4U-B-W3		
	.39	5800		.31	.43	1.22	1.54	.51	.94	.75	37.0	11.47			
	12	400	9/16-18 UNF	7	10	28	36	11	19	22	30	3,00	FI-GE-12L9/16U-B-W3		
	.47	5800		.28	.39	1.10	1.42	.43	.75	.87	22.2	6.61			
	12	400	3/4-16 UNF	10	11	31	39	13	24	22	50	4,89	FI-GE-12L3/4U-B-W3		
	.47	5800		.39	.43	1.22	1.54	.51	.94	.87	37.0	10.75			
	12	400	7/8-14 UNF	10	12,7	34	42	14,3	27	22	60	7,48	FI-GE-12L7/8U-B-W3		
	.47	5800		.39	.50	1.34	1.65	.56	1.06	.87	44.4	16.46			
	15	400	3/4-16 UNF	11	11	32	40	14	24	27	50	2,40	FI-GE-15L3/4U-B-W3		
	.59	5800		.43	.43	1.26	1.57	.55	.94	1.06	37.0	5.29			
	15	400	7/8-14 UNF	12	12,7	34,7	42,7	15	27	27	60	7,41	FI-GE-15L7/8U-B-W3		
	.59	5800		.47	.50	1.37	1.68	.59	1.06	1.06	44.4	16.30			
	18	400	3/4-16 UNF	11	11	33	42	14,5	27	32	50	6,86	FI-GE-18L3/4U-B-W3		
	.71	5800		.43	.43	1.30	1.65	.57	1.06	1.26	37.0	15.09			
18	400	7/8-14 UNF	14	12,7	34,7	43,7	14,5	27	32	60	7,36	FI-GE-18L7/8U-B-W3			
.71	5800		.55	.50	1.37	1.72	.57	1.06	1.26	44.4	16.19				
22	250	7/8-14 UNF	14	12,7	37	46	16,8	32	36	60	9,44	FI-GE-22L7/8U-B-W3			
.87	3625		.55	.50	1.46	1.81	.66	1.26	1.42	44.4	20.78				
22	250	1 1/16-12 UN	18	15	39	48	16,5	32	36	95	10,50	FI-GE-22L1-1/16U-B-W3			
.87	3625		.71	.59	1.54	1.89	.65	1.26	1.42	70.3	23.10				
22	250	1 5/16-12 UN	19	15	40	49	17,5	41	36	150	18,00	FI-GE-22L1-5/16U-B-W3			
.87	3625		.75	.59	1.57	1.93	.69	1.61	1.42	111.0	39.60				
28	250	7/8-14 UNF	24	12,7	37,7	45,7	17,5	41	41	60	14,09	FI-GE-28L7/8U-B-W3			
1.10	3625		.94	.50	1.48	1.80	.69	1.61	1.61	44.4	31.01				
28	250	1 1/16-12 UN	18	15	40	49	17,5	41	41	95	15,30	FI-GE-28L1-1/16U-B-W3			
1.10	3625		.71	.59	1.57	1.93	.69	1.61	1.61	70.3	33.66				
28	250	1 5/16-12 UN	19	15	40	49	17,5	41	41	150	17,20	FI-GE-28L1-5/16U-B-W3			
1.10	3625		.75	.59	1.57	1.93	.69	1.61	1.61	111.0	38.84				
35	250	1 5/16-12 UN	22	15	43	54	17,5	46	50	150	22,80	FI-GE-35L1-5/16U-B-W3			
1.38	3625		.87	.59	1.69	2.13	.69	1.81	1.97	111.0	50.16				
35	250	1 5/8-12 UN	30	15	43	54	17,5	50	50	200	28,00	FI-GE-35L1-5/8U-B-W3			
1.38	3625		1.18	.59	1.69	2.13	.69	1.97	1.97	148.0	61.60				
42	250	1 5/8-12 UN	30	15	45	57	19	55	60	200	35,36	FI-GE-42L1-5/8U-B-W3			
1.65	3625		1.18	.59	1.77	2.24	.75	2.17	2.36	148.0	77.79				

¹ Approximate dimension in assembled condition.

² Weight excluding cutting ring and union nut.

³ Standard scope of delivery: Fitting body only.

Male stud acc. to ISO 11926-2/-3

Port acc. to ISO 11926-1

Torque recommendations for Steel mating material.

Standard seal material is NBR (Buna-N®).



**Straight Male Stud Fitting
Type FI-GE-...-U • Series S**

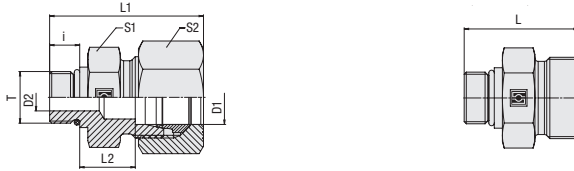

C

O-Ring

UN/UNF Thread

Series	Tube OD (mm/in)	PN (bar/PSI)	Dimensions (mm/in)									Torque (N·m/lb·ft)	Weight (kg/lbs) ca. per 100 ²	Ordering Codes ³
			Thread	T	D2	i	L	L1 ¹	L2	S1	S2			
S	8	630	7/16-20 UNF	4,5	9	29	38	13	17	19	20	2,65	FI-GE-08S7/16U-B-W3	
	.31	9135		.18	.35	1.14	1.50	.51	.67	.75	14.8	5.83		
	10	630	9/16-18 UNF	5	10	32	41	14,5	19	22	35	3,73	FI-GE-10S9/16U-B-W3	
	.39	9135		.20	.39	1.26	1.61	.57	.75	.87	25.9	8.20		
	12	630	9/16-18 UNF	7,5	12	36	45	16,5	24	24	35	6,09	FI-GE-12S9/16U-B-W3	
	.47	9135		.30	.47	1.42	1.77	.65	.94	.94	25.9	13.40		
	12	630	3/4-16 UNF	8	11	36	45	17,5	24	24	70	6,89	FI-GE-12S3/4U-B-W3	
	.47	9135		.31	.43	1.42	1.77	.69	.94	.94	51.8	15.15		
	16	630	3/4-16 UNF	8	11	35	45	15,5	24	30	70	6,68	FI-GE-16S3/4U-B-W3	
	.63	9135		.31	.43	1.38	1.77	.61	.94	1.18	51.8	14.70		
	16	630	7/8-14 UNF	12	12,7	39,7	49,7	18,5	27	30	100	9,47	FI-GE-16S7/8U-B-W3	
	.63	9135		.47	.50	1.56	1.96	.73	1.06	1.18	74.0	20.84		
	20	400	3/4-16 UNF	8	11	42	53	20,5	32	36	70	11,83	FI-GE-20S3/4U-B-W3	
	.79	5800		.31	.43	1.65	2.09	.81	1.26	1.42	51.8	26.02		
	20	400	7/8-14 UNF	12	12,7	44	55	20,8	32	36	100	15,20	FI-GE-20S7/8U-B-W3	
	.79	5800		.47	.50	1.73	2.17	.82	1.26	1.42	74.0	33.44		
	20	400	1 1/16-12 UN	16	15	46	57	20,5	32	36	170	19,70	FI-GE-20S1-1/16U-B-W3	
	.79	5800		.63	.59	1.81	2.24	.81	1.26	1.42	125.8	43.34		
	25	400	1 1/16-12 UN	16	18,5	50	62	23	36	46	170	24,20	FI-GE-25S1-1/16U-B-W3	
	.98	5800		.63	.73	1.97	2.44	.91	1.42	1.81	125.8	53.24		
	25	400	1 5/16-12 UN	20	18,5	50	62	23	41	46	270	28,90	FI-GE-25S1-5/16U-B-W3	
	.98	5800		.79	.73	1.97	2.44	.91	1.61	1.81	199.8	63.58		
	30	400	1 5/16-12 UN	20	18,5	52	65	23,5	46	50	270	30,70	FI-GE-30S1-5/16U-B-W3	
	1.18	5800		.79	.73	2.05	2.56	.93	1.81	1.97	199.8	67.54		
	30	400	1 5/8-12 UN	25	18,5	52	65	23,5	50	50	285	38,10	FI-GE-30S1-5/8U-B-W3	
	1.18	5800		.98	.73	2.05	2.56	.93	1.97	1.97	210.9	83.82		
	38	315	1 5/8-12 UN	25	18,5	57	72	22,5	55	60	285	50,70	FI-GE-38S1-5/8U-B-W3	
	1.50	4568		.98	.73	2.24	2.83	.89	2.17	2.36	210.9	111.54		

Ordering Codes

***FI-GE*-10*L*3/4*U*-B*-W3*-MS**

- * Straight Male Stud Fitting **FI-GE**
- * Outside Tube Diameter D1 (in mm) **-10**
- * Series Light Series (page 60) **L**
Heavy Series (page 61) **S**
- * Thread Size acc. to dimension table **3/4**
- Please always indicate thread sizes, e.g. 3/4!
- * Thread Type UN/UNF Thread with O-Ring **U**
- * Seal Material NBR (Buna-N®) **-B**
FKM (Viton®) **-V**
EPDM **-E**
- * Material Code Steel, zinc/nickel-plated **-W3**
- Please contact STAUFF for alternative materials and surface finishings.
- * Assembling / Kitting Fitting body only **—**
Fitting body supplied with cutting ring and union nut **-MS**
Fitting body supplied with soft-sealing cutting ring and union nut **-MSV**

¹ Approximate dimension in assembled condition.

² Weight excluding cutting ring and union nut.

³ Standard scope of delivery: Fitting body only.

Standard seal material is NBR (Buna-N®).

Male stud acc. to ISO 11926-2/-3

Port acc. to ISO 11926-1

Torque recommendations for Steel mating material.

Connecting Parts

- Cutting Ring Type **FI-DS** Page 26
- Soft-Sealing Cutting Ring Type **FI-WDDS** Page 27
- Support Sleeve Type **FI-VH** Page 28
- STAUFF Form Ring Type **FI-AR** Page 30
- Union Nut Type **FI-M** Page 31
- 37° Flared Tube Fitting Set Type **FI-AB** Page 35

Spare Parts / Accessories

- O-Ring Type **O-RING** Page 207



Male Stud Elbow
Type FI-WE-...-R • Series L / S

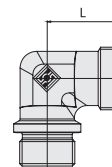
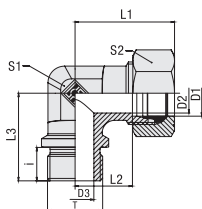

C

Ordering Codes

***FI-WE*-25*S*R*-W3*-MS**

* Male Stud Elbow		FI-WE
* Outside Tube Diameter D1 (in mm)		-25
* Series	Light Series Heavy Series	L S
* Thread Type	Whitworth Parallel Pipe Thread (BSPP)	R
If required, please indicate special sizes, e.g. R3/4!		
* Material Code	Steel, zinc/nickel-plated	-W3
Please contact STAUFF for alternative materials and surface finishings.		
* Assembling / Kitting	Fitting body only	—
	Fitting body supplied with cutting ring and union nut	-MS
	Fitting body supplied with soft-sealing cutting ring and union nut	-MSV

Whitworth Parallel Pipe Thread (BSPP)

Metallic Sealing Edge

Series	Tube OD (mm/in)	PN (°BSP)	Dimensions (mm/in)											Torque (N·m/ft·lb)	Weight (kg/lbs) ca. per 100 ²	Ordering Codes ³
			Thread	T	D2	D3	i	L	L1 ¹	L2	L3	S1	S2			
L	22	160	G 3/4	19	18	16	35	44	27,5	42	27	36	180	1,78	FI-WE-22LR-W3	
	.87	2320		.75	.71	.63	1.38	1.73	1.08	1.65	1.06	1.42	133,2	3,92		
	28	160	G 1	24	23	18	38	47	30,5	48	36	41	330	3,12	FI-WE-28LR-W3	
	1.10	2320		.94	.91	.71	1.50	1.85	1.20	1.89	1.42	1.61	244,2	6,86		
	35	160	G 1 1/4	30	30	20	45	56	34,5	54	41	50	540	4,67	FI-WE-35LR-W3	
	1.38	2320		1.18	1.18	.79	1.77	2.20	1.36	2.13	1.61	1.97	399,6	10,27		
42	160	G 1 1/2	36	36	22	51	63	40	61	50	60	630	6,90	FI-WE-42LR-W3		
1.65	2320		1.42	1.42	.87	2.01	2.48	1.57	2.40	1.97	2.36	466,2	15,18			
S	20	420	G 3/4	16	16	16	37	48	26,5	42	27	36	270	2,15	FI-WE-20SR-W3	
	.79	6090		.63	.63	.63	1.46	1.89	1.04	1.65	1.06	1.42	199,8	4,73		
	25	420	G 3/4	20	18	16	42	54	30	48	36	46	340	3,77	FI-WE-25SR3/4-W3	
	.98	6090		.79	.71	.63	1.65	2.13	1.18	1.89	1.42	1.81	251,6	8,29		
	25	420	G 1	20	20	18	42	54	30	48	36	46	340	4,06	FI-WE-25SR-W3	
	.98	6090		.79	.79	.71	1.65	2.13	1.18	1.89	1.42	1.81	251,6	8,93		
	30	250	G 1 1/4	25	25	20	49	62	35,5	54	41	50	540	6,28	FI-WE-30SR-W3	
	1.18	3625		.98	.98	.79	1.93	2.44	1.40	2.13	1.61	1.97	399,6	13,82		
	38	250	G 1 1/2	32	32	22	57	72	41	61	50	60	700	9,15	FI-WE-38SR-W3	
	1.50	3625		1.26	1.26	.87	2.24	2.83	1.61	2.40	1.97	2.36	518,0	20,13		

¹ Approximate dimension in assembled condition.

² Weight excluding cutting ring and union nut.

³ Standard scope of delivery: Fitting body only.

Male stud acc. to DIN 3852-2 (Form B) / ISO 1179-4 (Type B)
Port acc. to DIN 3852-2 (Form X) / ISO 1179-1

Torque recommendations for Steel mating material.

Connecting Parts

	Cutting Ring Type FI-DS	Page 26
	Soft-Sealing Cutting Ring Type FI-WDDS	Page 27
	Support Sleeve Type FI-VH	Page 28
	STAUFF Form Ring Type FI-AR	Page 30
	Union Nut Type FI-M	Page 31
	37° Flared Tube Fitting Set Type FI-AB	Page 35



Male Stud Elbow
Type FI-WE...-M • Series L / S

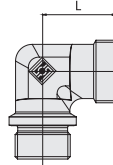
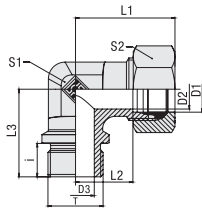

C

Metallic Sealing Edge

Metric Parallel Thread

Series	Tube OD PN		Dimensions											Torque (^{N·m} / _{ft·lb})	Weight (^{kg} / _{lbs}) ca.	Ordering Codes ³
	(mm/in)	(^{bar} / _{psi})	(mm/in)													
L	22	250	M 26 x	19	18	16	35	44	27,5	42	27	36	190	1,73	FI-WE-22LM-W3	
	.87	3625	1,5	.75	.71	.63	1.38	1.73	1.08	1.65	1.06	1.42	140,6	3,81		
	28	250	M 33 x 2	24	23	18	38	47	30,5	48	36	41	340	3,04	FI-WE-28LM-W3	
	1.10	3625		.94	.91	.71	1.50	1.85	1.20	1.89	1.42	1.61	251,6	6,69		
	35	250	M 42 x 2	30	30	20	45	56	34,5	54	41	50	500	4,70	FI-WE-35LM-W3	
	1.38	3625		1.18	1.18	.79	1.77	2.20	1.36	2.13	1.61	1.97	370,0	10,35		
42	250	M 48 x 2	36	36	22	51	63	40	61	50	60	630	6,96	FI-WE-42LM-W3		
1.65	3625		1.42	1.42	.87	2.01	2.48	1.57	2.40	1.97	2.36	466,2	15,31			
S	20	420	M 27 x 2	16	16	16	37	48	26,5	42	27	36	270	2,14	FI-WE-20SM-W3	
	.79	6090		.63	.63	.63	1.46	1.89	1.04	1.65	1.06	1.42	199,8	4,71		
	25	250	M 33 x 2	20	20	18	42	54	30	48	36	46	410	4,46	FI-WE-25SM-W3	
	.98	3625		.79	.79	.71	1.65	2.13	1.18	1.89	1.42	1.81	303,4	9,81		
	30	250	M 42 x 2	25	25	20	49	62	35,5	54	41	50	540	6,33	FI-WE-30SM-W3	
	1.18	3625		.98	.98	.79	1.93	2.44	1.40	2.13	1.61	1.97	399,6	13,93		
	38	250	M 48 x 2	32	32	22	57	72	41	61	50	60	700	9,24	FI-WE-38SM-W3	
	1.50	3625		1.26	1.26	.87	2.24	2.83	1.61	2.40	1.97	2.36	518,0	20,33		

¹ Approximate dimension in assembled condition.
² Weight excluding cutting ring and union nut.
³ Standard scope of delivery: Fitting body only.

Male stud acc. to DIN 3852-1 (Form B) / ISO 9974-3 (Type B)
 Port acc. to DIN 3852-1 (Form X) / ISO 9974-1
 Torque recommendations for Steel mating material.

Ordering Codes

***FI-WE*-25*S*M*-W3*-MS**

- * Male Stud Elbow **FI-WE**
- * Outside Tube Diameter D1 (in mm) **-25**
- * Series Light Series **L**
Heavy Series **S**
- * Thread Type Metric Parallel Thread **M**

If required, please indicate special sizes, e.g. M27x2!

- * Material Code Steel, zinc/nickel-plated **-W3**

Please contact STAUFF for alternative materials and surface finishings.

- * Assembling / Kitting Fitting body only **—**
 Fitting body supplied with cutting ring and union nut **-MS**
 Fitting body supplied with soft-sealing cutting ring and union nut **-MSV**

Connecting Parts

- Cutting Ring Type **FI-DS** Page 26
- Soft-Sealing Cutting Ring Type **FI-WDDS** Page 27
- Support Sleeve Type **FI-VH** Page 28
- STAUFF Form Ring Type **FI-AR** Page 30
- Union Nut Type **FI-M** Page 31
- 37° Flared Tube Fitting Set Type **FI-AB** Page 35



Male Stud Elbow
Type FI-WE-...-Rk ■ Series LL / L / S

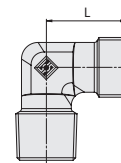
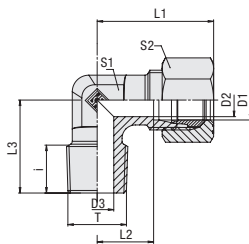

C



Ordering Codes

***FI-WE*-10*L*Rk*-W3*-MS**

- * Male Stud Elbow **FI-WE**
- * Outside Tube Diameter D1 (in mm) **-10**
- * Series **LL**
 Extra-Light Series **L**
 Light Series **S**
 Heavy Series
- * Thread Type **Rk**
 Whitworth Taper Pipe Thread (BSPT)
- If required, please indicate special sizes, e.g. R3/8k!
- * Material Code **-W3**
 Steel, zinc/nickel-plated
- Please contact STAUFF for alternative materials and surface finishings.
- * Design **—**
 Made from forging blanks **PR**
 Made from profile material
- * Assembling / Kitting **—**
 Fitting body only **-MS**
 Fitting body supplied with cutting ring and union nut **-MSV**
 Fitting body supplied with soft-sealing cutting ring and union nut

Connecting Parts

-  Cutting Ring
Type **FI-DS** Page 26
-  Soft-Sealing Cutting Ring
Type **FI-WDDS** Page 27
-  Support Sleeve
Type **FI-VH** Page 28
-  STAUFF Form Ring
Type **FI-AR** Page 30
-  Union Nut
Type **FI-M** Page 31
-  37° Flared Tube Fitting Set
Type **FI-AB** Page 35

Whitworth Taper Pipe Thread (BSPT)

Series	Tube OD PN		Dimensions										Weight (^{kg} / _{lbs}) ca. per 100 ²	Ordering Codes ³		
	(mm/in)	(^{mm} / _{psi})	(mm/in)	Thread	T	D2	D3	i	L	L1 ¹	L2	L3			S1	S2
LL	4	100	R 1/8 keg.	3	3	8	15	21	11	17	11	10	14,6		FI-WE-04LLRk-W3-PR	
	.16	1450		.12	.12	.31	.59	.83	.43	.67	.43	.39	3,12			
	6	100	R 1/8 keg.	4,5	4,5	8	15	21	9,5	17	11	12	1,73		FI-WE-06LLRk-W3-PR	
	.24	1450		.18	.18	.31	.59	.83	.37	.67	.43	.47	3,81			
	8	100	R 1/8 keg.	6	6	8	17	23	11,5	20	12	14	2,63		FI-WE-08LLRk-W3-PR	
	.31	1450		.24	.24	.31	.67	.91	.45	.79	.47	.55	5,79			
	10	100	R 1/4 keg.	8	7	12	21,5	27,5	16	26	14	14	9,10		FI-WE-10LLRk-W3	
	.39	1450		.31	.28	.47	.85	1,08	.63	1,02	.55	.55	20,02			
	12	100	R 1/4 keg.	10	7	9,9	22	28	16	23	14	17	11,40		FI-WE-12LLRk-W3	
	.47	1450		.39	.28	.39	.87	1,10	.63	.91	.55	.67	25,08			
	L	6	315	R 1/8 keg.	4	4	8	19	27	12	20	12	14	1,96		FI-WE-06LRk-W3
		.24	4568		.16	.16	.31	.75	1,06	.47	.79	.47	.55	4,32		
6		315	R 1/4 keg.	4	6	12	21	29	14	25,5	12	14	2,93		FI-WE-06LR1/4k-W3	
.24		4568		.16	.24	.47	.83	1,14	.55	1,00	.47	.55	6,44			
8		315	R 1/8 keg.	6	4	8	21	29	14	26	12	17	2,64		FI-WE-08LR1/8k-W3	
.31		4568		.24	.16	.31	.83	1,14	.55	1,02	.47	.67	5,80			
8		315	R 1/4 keg.	6	6	12	21	29	14	26	12	17	2,93		FI-WE-08LRk-W3	
.31		4568		.24	.24	.47	.83	1,14	.55	1,02	.47	.67	6,45			
8		315	R 3/8 keg.	6	9	14	24	32	17	28	14	17	4,34		FI-WE-08LR3/8k-W3	
.31		4568		.24	.35	.55	.94	1,26	.67	1,10	.55	.67	9,54			
10		315	R 1/4 keg.	8	7	13	22	30	15	27	14	19	3,53		FI-WE-10LRk-W3	
.39		4568		.31	.28	.51	.87	1,18	.59	1,06	.55	.75	7,76			
10		315	R 3/8 keg.	8	8	12,5	22	30	15	28	14	19	4,29		FI-WE-10LR3/8k-W3	
.39		4568		.31	.31	.49	.87	1,18	.59	1,10	.55	.75	9,43			
12		315	R 1/4 keg.	10	7	14,3	24	32	17	27	17	22	4,57		FI-WE-12LR1/4k-W3	
.47		4568		.39	.28	.56	.94	1,26	.67	1,06	.67	.87	10,06			
12		315	R 3/8 keg.	10	9	13	24	32	17	28,5	17	22	5,33		FI-WE-12LRk-W3	
.47		4568		.39	.35	.51	.94	1,26	.67	1,12	.67	.87	11,72			
12		315	R 1/2 keg.	10	10	14	28	36	21	34	19	22	9,94		FI-WE-12LR1/2k-W3	
.47		4568		.39	.39	.55	1,10	1,42	.83	1,34	.75	.87	21,87			
15		315	R 3/8 keg.	12	9	14	28	36	21	34	19	27	8,79		FI-WE-15LR3/8k-W3	
.59		4568		.47	.35	.55	1,10	1,42	.83	1,34	.75	1,06	19,33			
15		315	R 1/2 keg.	12	12	16	28	36	21	34	19	27	9,12		FI-WE-15LRk-W3	
.59		4568		.47	.47	.63	1,10	1,42	.83	1,34	.75	1,06	20,06			
18	315	R 1/2 keg.	15	14	17,5	31	40	23,5	36	24	32	11,63		FI-WE-18LRk-W3		
.71	4568		.59	.55	.69	1,22	1,57	.93	1,42	.94	1,26	25,58				
22	160	R 3/4 keg.	19	18	11	35	44	28,5	42,5	27	36	16,80		FI-WE-22LRk-W3		
.87	2320		.75	.71	.43	1,38	1,73	1,12	1,67	1,06	1,42	36,96				
S	6	400	R 1/4 keg.	4	4	12	23	31	16	26	12	17	5,73		FI-WE-06SRk-W3	
	.24	5800		.16	.16	.47	.91	1,22	.63	1,02	.47	.67	12,60			
	8	400	R 1/4 keg.	5	5	13	24	32	17	27	14	19	4,70		FI-WE-08SRk-W3	
	.31	5800		.20	.20	.51	.94	1,26	.67	1,06	.55	.75	10,34			
	10	400	R 1/4 keg.	7	5	13	25	34	17,5	28	17	22	5,94		FI-WE-10SR1/4k-W3	
	.39	5800		.28	.20	.51	.98	1,34	.69	1,10	.67	.87	13,06			
	10	400	R 3/8 keg.	7	7	13	25	34	17,5	28	17	22	6,71		FI-WE-10SRk-W3	
	.39	5800		.28	.28	.51	.98	1,34	.69	1,10	.67	.87	14,77			
	12	400	R 3/8 keg.	8	7	12	29	38	21,5	28	17	24	7,78		FI-WE-12SRk-W3	
	.47	5800		.31	.28	.47	1,14	1,50	.85	1,10	.67	.94	17,12			
	12	400	R 1/2 keg.	8	10	14	30	39	22,5	32	19	24	4,67		FI-WE-12SR1/2k-W3	
	.47	5800		.31	.39	.55	1,18	1,54	.89	1,26	.75	.94	10,27			
	14	400	R 1/2 keg.	10	10	14	30	40	22	32	19	27	10,53		FI-WE-14SRk-W3	
	.55	5800		.39	.39	.55	1,18	1,57	.87	1,26	.75	1,06	23,17			
	16	400	R 1/2 keg.	12	12	14	34	44	25,5	32	24	30	13,60		FI-WE-16SRk-W3	
	.63	5800		.47	.47	.55	1,34	1,73	1,00	1,26	1,78	66,0	29,92			
	16	400	R 3/4 keg.	12	12	14	34	44	25,5	32	24	30	22,00		FI-WE-16SR3/4k-W3	
	.63	5800		.47	.47	.55	1,34	1,73	1,00	1,26	.94	1,18	48,40			
	20	400	R 1/2 keg.	16	10	14	37	48	26,5	42	27	36	21,00		FI-WE-20SR1/2k-W3	
	.79	5800		.63	.39	.55	1,46	1,89	1,04	1,65	1,06	1,42	46,20			

¹ Approximate dimension in assembled condition.
² Weight excluding cutting ring and union nut.
³ Standard scope of delivery: Fitting body only.

Male stud acc. to DIN 3852-2 (Form C)
 Port acc. to DIN 3852-2 (Form Z)

Suitable liquid / plastic sealant required.



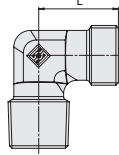
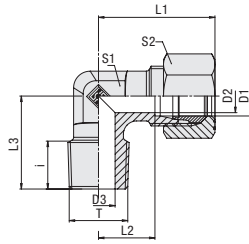

Male Stud Elbow
Type FI-WE-...-Mk ■ Series LL / L / S



Metric Taper Thread

Series	Tube OD (mm/in)	PN (bar/PSI)	Dimensions (mm/in) Thread T	D2	D3	i	L	L1 ¹	L2	L3	S1	S2	Weight (kg/lbs) ca. per 100 ²	Ordering Codes ³
LL	4	100	M 8 x 1 keg.	3	3,5	8	15	21	11	17	9	10	1,46	FI-WE-04LLMk-W3-PR
	.16	1450		.12	.14	.31	.59	.83	.43	.67	.35	.39	3.12	
	6	100	M 10 x 1 keg.	4,5	4,5	8	15	21	9,5	17	11	12	1,74	FI-WE-06LLMk-W3-PR
	.24	1450		.18	.18	.31	.59	.83	.37	.67	.43	.47	3.83	
	8	100	M 10 x 1 keg.	6	6	8	17	23	11,5	20	12	14	2,82	FI-WE-08LLMk-W3-PR
.31	1450		.24	.24	.31	.67	.91	.45	.79	.47	.55	6.20		
L	6	315	M 10 x 1 keg.	4	4	8	19	27	12	20	12	14	2,16	FI-WE-06LMk-W3
	.24	4568		.16	.16	.31	.75	1.06	.47	.79	.47	.55	4.75	
	8	315	M 12 x 1,5 keg.	6	6	12	21	29	14	26	12	17	2,67	FI-WE-08LMk-W3
	.31	4568		.24	.24	.47	.83	1.14	.55	1.02	.47	.67	5.88	
	10	315	M 14 x 1,5 keg.	8	7	11,5	22	30	15	27	14	19	4,19	FI-WE-10LMk-W3
	.39	4568		.31	.28	.45	.87	1.18	.59	1.06	.55	.75	9.23	
	12	315	M 16 x 1,5 keg.	10	9	11,5	24	32	17	28	17	22	5,05	FI-WE-12LMk-W3
	.47	4568		.39	.35	.45	.94	1.26	.67	1.10	.67	.87	11.10	
	15	315	M 18 x 1,5 keg.	12	11	12	28	36	21	32	19	27	8,82	FI-WE-15LMk-W3
	.59	4568		.47	.43	.47	1.10	1.42	.83	1.26	.75	1.06	19.41	
	18	315	M 22 x 1,5 keg.	15	14	14	31	40	23,5	36	24	32	12,56	FI-WE-18LMk-W3
	.71	4568		.59	.55	.55	1.22	1.57	.93	1.42	.94	1.26	27.64	
	S	6	400	M 12 x 1,5 keg.	4	4	12	23	31	16	26	12	17	3,44
.24		5800		.16	.16	.47	.91	1.22	.63	1.02	.47	.67	7.56	
8		400	M 14 x 1,5 keg.	5	5	11,5	24	32	17	27	14	19	5,33	FI-WE-08SMk-W3
.31		5800		.20	.20	.45	.94	1.26	.67	1.06	.55	.75	11.73	
10		400	M 16 x 1,5 keg.	7	7	11,5	25	34	17,5	28	17	22	6,35	FI-WE-10SMk-W3
.39		5800		.28	.28	.45	.98	1.34	.69	1.10	.67	.87	13.97	
12		400	M 18 x 1,5 keg.	8	8	12	29	38	21,5	28	17	24	8,19	FI-WE-12SMk-W3
.47		5800		.31	.31	.47	1.14	1.50	.85	1.10	.67	.94	18.02	
14		400	M 20 x 1,5 keg.	10	10	14	30	40	22	32	19	27	11,45	FI-WE-14SMk-W3
.55		5800		.39	.39	.55	1.18	1.57	.87	1.26	.75	1.06	25.19	
16	400	M 22 x 1,5 keg.	12	12	14	33	43	24,5	32	24	30	9,62	FI-WE-16SMk-W3	
.63	5800		.47	.47	.55	1.30	1.69	.96	1.26	.94	1.18	21.17		

¹ Approximate dimension in assembled condition.
² Weight excluding cutting ring and union nut.
³ Standard scope of delivery: Fitting body only.

Male stud acc. to DIN 3852-1 (Form C)
 Port acc. to DIN 3852-1 (Form Z)

Suitable liquid / plastic sealant required.

Ordering Codes

***FI-WE*-10*L*Mk*-W3*-MS**

- * Male Stud Elbow FI-WE
- * Outside Tube Diameter D1 (in mm) -10
- * Series LL
L
S
- * Thread Type Metric Taper Thread
Mk
- If required, please indicate special sizes, e.g. M12x1.5k!
- * Material Code Steel, zinc/nickel-plated
-W3
- Please contact STAUFF for alternative materials and surface finishings.
- * Design Made from forging blanks
Made from profile material
—
PR
- * Assembling / Kitting Fitting body only
—
Fitting body supplied with cutting ring and union nut
-MS
Fitting body supplied with soft-sealing cutting ring and union nut
-MSV

Connecting Parts

-  Cutting Ring
Type **FI-DS** Page 26
-  Soft-Sealing Cutting Ring
Type **FI-WDDS** Page 27
-  Support Sleeve
Type **FI-VH** Page 28
-  STAUFF Form Ring
Type **FI-AR** Page 30
-  Union Nut
Type **FI-M** Page 31
-  37° Flared Tube Fitting Set
Type **FI-AB** Page 35



Male Stud Elbow
Type FI-WE-...-N • Series LL / L

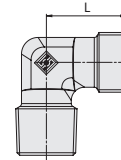
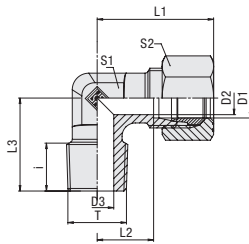

C



NPT Thread

Ordering Codes

***FI-WE*-10*L*1/4*N*-W3*-MS**

* Male Stud Elbow	FI-WE
* Outside Tube Diameter D1 (in mm)	-10
* Series	Extra-Light Series (page 66) LL Light Series (page 66) L Heavy Series (page 67) S
* Thread Size	acc. to dimension table 1/4
Please always indicate thread sizes, e.g. 1/4!	
* Thread Type	NPT Thread N
* Material Code	Steel, zinc/nickel-plated -W3
Please contact STAUFF for alternative materials and surface finishings.	
* Design	Made from forging blanks — Made from profile material PR
* Assembling / Kitting	Fitting body only — Fitting body supplied with cutting ring and union nut -MS Fitting body supplied with soft-sealing cutting ring and union nut -MSV

Series	Tube OD PN		Dimensions											Weight (kg/lbs) ca. per 100 ²	Ordering Codes ³
	(mm/in) D1	(bar/psi)	(mm/in) Thread T	D2	D3	i	L	L1 ¹	L2	L3	S1	S2			
LL	4	100	1/8 NPT	3	4	9,9	15	21	11	15,6	11	10	1,81	FI-WE-04LL1/8N-W3-PR	
	.16	1450		.12	.16	.39	.59	.83	.43	.61	.43	.39	3,98		
	6	100	1/8 NPT	4,5	4,5	8	15	21	9,5	17	11	12	1,57	FI-WE-06LL1/8N-W3-PR	
	.24	1450		.18	.18	.31	.59	.83	.37	.67	.43	.47	3,45		
L	8	100	1/8 NPT	6	6	10	17	23	11,5	20	12	14	2,64	FI-WE-08LL1/8N-W3-PR	
	.31	1450		.24	.24	.39	.67	.91	.45	.79	.47	.55	5,80		
	6	315	1/8 NPT	4	5	8	19	27	11,5	20	12	14	1,91	FI-WE-06L1/8N-W3	
	.24	4568		.16	.20	.31	.75	1.06	.45	.79	.47	.55	4,20		
S	6	315	1/4 NPT	4	7	10	21	29	14	26	14	14	2,80	FI-WE-06L1/4N-W3	
	.24	4568		.16	.28	.39	.83	1.14	.55	1.02	.55	.55	6,15		
	6	315	3/8 NPT	4	8	10,5	25	33	18	28	17	14	5,63	FI-WE-06L3/8N-W3	
	.24	4568		.16	.31	.41	.98	1.30	.71	1.10	.67	.55	12,38		
N	8	315	1/8 NPT	6	4	7	21	29	14	26	12	17	2,36	FI-WE-08L1/8N-W3	
	.31	4568		.24	.16	.28	.83	1.14	.55	1.02	.47	.67	5,20		
	8	315	1/4 NPT	6	6	11,4	21	29	14	26	12	17	2,92	FI-WE-08L1/4N-W3	
	.31	4568		.24	.24	.45	.83	1.14	.55	1.02	.47	.67	6,42		
N	10	315	1/4 NPT	8	7	13	22	30	15	27	14	19	3,56	FI-WE-10L1/4N-W3	
	.39	4568		.31	.28	.51	.87	1.18	.59	1.06	.55	.75	7,82		
	10	315	3/8 NPT	8	8	10,5	24	32	17	28	17	19	5,67	FI-WE-10L3/8N-W3	
	.39	4568		.31	.31	.41	.94	1.26	.67	1.10	.67	.75	12,47		
N	12	315	1/4 NPT	10	7	13	24	32	17	28	17	22	4,81	FI-WE-12L1/4N-W3	
	.47	4568		.39	.28	.51	.94	1.26	.67	1.10	.67	.87	10,58		
	12	315	3/8 NPT	10	8	10,5	24	32	17	28	17	22	4,87	FI-WE-12L3/8N-W3	
	.47	4568		.39	.31	.41	.94	1.26	.67	1.10	.67	.87	10,71		
N	12	315	1/2 NPT	10	11	14	28	36	21	34	19	22	7,99	FI-WE-12L1/2N-W3	
	.47	4568		.39	.43	.55	1.10	1.42	.83	1.34	.75	.87	17,57		
	15	315	1/2 NPT	12	14	14	28	39	21	34	19	27	8,05	FI-WE-15L1/2N-W3	
	.59	4568		.47	.55	.55	1.10	1.54	.83	1.34	.75	1.06	17,70		
N	18	315	1/2 NPT	15	12	14	31	40	23,5	36	24	32	12,79	FI-WE-18L1/2N-W3	
	.71	4568		.59	.47	.55	1.22	1.57	.93	1.42	.94	1.26	28,14		
	22	160	3/4 NPT	19	16	14	35	44	27,5	42	27	36	17,07	FI-WE-22L3/4N-W3	
	.87	2320		.75	.63	.55	1.38	1.73	1.08	1.65	1.06	1.42	37,56		
N	28	160	1 NPT	24	21	17,5	38	47	30,5	48	36	41	32,40	FI-WE-28L1N-W3	
	1.10	2320		.94	.83	.69	1.50	1.85	1.20	1.89	1.42	1.61	71,28		
	35	160	1 1/4 NPT	30	28	18	48	59	34,5	54	41	50	51,70	FI-WE-35L1-1/4N-W3	
	1.38	2320		1.18	1.10	.71	1.89	2.32	1.36	2.13	1.61	1.97	113,74		
N	42	160	1 1/2 NPT	36	34	18,5	54	66	43	61	50	60	74,60	FI-WE-42L1-1/2N-W3	
	1.65	2320		1.42	1.34	.73	2.13	2.60	1.69	2.40	1.97	2.36	164,12		

Connecting Parts

	Cutting Ring Type FI-DS	Page 26
	Soft-Sealing Cutting Ring Type FI-WDDS	Page 27
	Support Sleeve Type FI-VH	Page 28
	STAUFF Form Ring Type FI-AR	Page 30
	Union Nut Type FI-M	Page 31
	37° Flared Tube Fitting Set Type FI-AB	Page 35

¹ Approximate dimension in assembled condition.

² Weight excluding cutting ring and union nut.

³ Standard scope of delivery: Fitting body only.

Male stud acc. to ANSI/ASME B1.20.1-1983

Port acc. to ANSI/ASME B1.20.1-1983

Suitable liquid / plastic sealant required.



Male Stud Elbow
Type FI-WE-...-N • Series S

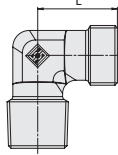
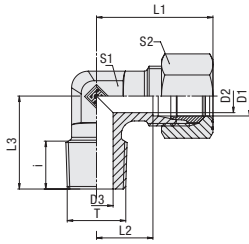

NPT Thread

Series	Tube OD (mm/in)	PN (bar/psi)	Dimensions (mm/in)											Weight (kg/lbs) ca. per 100 ²	Ordering Codes ³
			Thread	T	D2	D3	i	L	L1 ¹	L2	L3	S1	S2		
S	6	630	1/4 NPT	4	4	10	23	31	16	26	12	17	3,19	FI-WE-06S1/4N-W3	
	.24	9135		.16	.16	.39	.91	1.22	.63	1.02	.47	.67	7.02		
	8	630	1/4 NPT	5	5	10	24	32	17	27	14	19	4,41	FI-WE-08S1/4N-W3	
	.31	9135		.20	.20	.39	.94	1.26	.67	1.06	.55	.75	9.69		
	8	630	3/8 NPT	5	8	10,5	25	33	18	28	17	19	7,80	FI-WE-08S3/8N-W3	
	.31	9135		.20	.31	.41	.98	1.30	.71	1.10	.67	.75	17.16		
	8	630	1/2 NPT	5	10	14	30	38	23	34	19	19	8,30	FI-WE-08S1/2N-W3	
	.31	9135		.20	.39	.55	1.18	1.50	.91	1.34	.75	.75	18.26		
	10	630	1/4 NPT	7	5	10	25	34	17,5	28	17	22	6,17	FI-WE-10S1/4N-W3	
	.39	9135		.28	.20	.39	.98	1.34	.69	1.10	.67	.87	13.57		
	10	630	3/8 NPT	7	7	10,5	25	34	17,5	28	17	22	6,64	FI-WE-10S3/8N-W3	
	.39	9135		.28	.28	.41	.98	1.34	.69	1.10	.67	.87	14.62		
	12	630	1/4 NPT	8	5	15	29	38	21,5	29	17	24	7,87	FI-WE-12S1/4N-W3	
	.47	9135		.31	.20	.59	1.14	1.50	.85	1.14	.67	.94	17.31		
	12	630	3/8 NPT	8	8	10,5	29	38	21,5	28	17	24	7,76	FI-WE-12S3/8N-W3	
	.47	9135		.31	.31	.41	1.14	1.50	.85	1.10	.67	.94	17.07		
	12	630	1/2 NPT	8	10	14	30	39	22,5	34	19	24	11,23	FI-WE-12S1/2N-W3	
	.47	9135		.31	.39	.55	1.18	1.54	.89	1.34	.75	.94	24.70		
	14	630	1/2 NPT	10	10	14	30	40	22	34	19	27	8,88	FI-WE-14S1/2N-W3	
	.55	9135		.39	.39	.55	1.18	1.57	.87	1.34	.75	1.06	19.53		
	16	630	1/2 NPT	12	12	14	33	43	24,5	36	24	30	14,05	FI-WE-16S1/2N-W3	
	.63	9135		.47	.47	.55	1.30	1.69	.96	1.42	.94	1.18	30.90		
	20	400	3/4 NPT	16	16	14	37	48	26,5	42	27	36	19,28	FI-WE-20S3/4N-W3	
	.79	5800		.63	.63	.55	1.46	1.89	1.04	1.65	1.06	1.42	42.42		
	25	400	1 NPT	20	20	17,5	42	54	30	48	36	46	33,76	FI-WE-25S1N-W3	
	.98	5800		.79	.79	.69	1.65	2.13	1.18	1.89	1.42	1.81	74.26		
	30	400	1 1/4 NPT	25	25	18	49	62	35,5	54	41	50	60,30	FI-WE-30S1-1/4N-W3	
	1.18	5800		.98	.98	.71	1.93	2.44	1.40	2.13	1.61	1.97	132.66		
	38	315	1 1/2 NPT	32	32	18,5	58	73	40	61	50	60	91,80	FI-WE-38S1-1/2N-W3	
	1.50	4568		1.26	1.26	.73	2.28	2.87	1.57	2.40	1.97	2.36	201.96		

¹ Approximate dimension in assembled condition.

² Weight excluding cutting ring and union nut.

³ Standard scope of delivery: Fitting body only.

Male stud acc. to ANSI/ASME B1.20.1-1983

Port acc. to ANSI/ASME B1.20.1-1983

Suitable liquid / plastic sealant required.

Ordering Codes

FI-WE-10*L*1/4*N*-W3*-MS

- * Male Stud Elbow FI-WE
- * Outside Tube Diameter D1 (in mm) -10
- * Series LL
 Extra-Light Series (page 66) LL
 Light Series (page 66) L
 Heavy Series (page 67) S
- * Thread Size 1/4
 acc. to dimension table
- Please always indicate thread sizes, e.g. 1/4!
- * Thread Type N
 NPT Thread
- * Material Code -W3
 Steel, zinc/nickel-plated
- Please contact STAUFF for alternative materials and surface finishings.
- * Assembling / Kitting —
 Fitting body only
- MS
 Fitting body supplied with cutting ring and union nut
- MSV
 Fitting body supplied with soft-sealing cutting ring and union nut

Connecting Parts

-  Cutting Ring
Type FI-DS Page 26
-  Soft-Sealing Cutting Ring
Type FI-WDDS Page 27
-  Support Sleeve
Type FI-VH Page 28
-  STAUFF Form Ring
Type FI-AR Page 30
-  Union Nut
Type FI-M Page 31
-  37° Flared Tube Fitting Set
Type FI-AB Page 35



Male Stud Branch Tee
Type FI-TE-...-R ▪ Series L / S

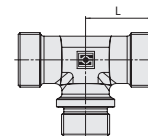
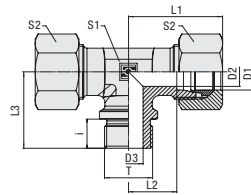

C

Whitworth Parallel Pipe Thread (BSPP)

Metallic Sealing Edge

Ordering Codes

***FI-TE*-22*L*R*-W3*-MS**

- * Male Stud Branch Tee **FI-TE**
- * Outside Tube Diameter D1 (in mm) **-22**
- * Series **L**
Light Series
Heavy Series **S**
- * Thread Type **R**
Whitworth Parallel Pipe Thread (BSPP)
- If required, please indicate special sizes, e.g. R1/2!
- * Material Code **-W3**
Steel, zinc/nickel-plated
- Please contact STAUFF for alternative materials and surface finishings.
- * Assembling / Kitting **—**
Fitting body only
- Fitting body supplied with cutting rings and union nuts **-MS**
- Fitting body supplied with soft-sealing cutting rings and union nuts **-MSV**

Series	Tube OD (mm/in)	PN (bar/psi)	Dimensions (mm/in)											Torque (N·m/ft·lb)	Weight (kg/lbs) ca. per 100 ²	Ordering Codes ³
			D1	Thread	T	D2	D3	i	L	L1 ¹	L2	L3	S1			
L	22	160	G 3/4	19	18	16	35	44	27,5	42	27	36	180	23,90	FI-TE-22LR-W3	
	.87	2320		.75	.71	.63	1.38	1.73	1.08	1.65	1.06	1.42	133.2	52.58		
	28	160	G 1	24	23	18	38	47	30,5	48	36	41	330	37,50	FI-TE-28LR-W3	
	1.10	2320		.94	.91	.71	1.50	1.85	1.20	1.89	1.42	1.61	244.2	82.50		
	35	160	G 1 1/4	30	30	20	45	56	34,5	54	41	50	540	56,50	FI-TE-35LR-W3	
	1.38	2320		1.18	1.18	.79	1.77	2.20	1.36	2.13	1.61	1.97	399.6	124.30		
42	160	G 1 1/2	36	36	22	51	63	40	61	50	60	630	80,50	FI-TE-42LR-W3		
1.65	2320		1.42	1.42	.87	2.01	2.48	1.57	2.40	1.97	2.36	466.2	177.10			
S	20	400	G 3/4	16	16	16	37	48	26,5	42	27	36	270	28,80	FI-TE-20SR-W3	
	.79	5800		.63	.63	.63	1.46	1.89	1.04	1.65	1.06	1.42	199.8	63.36		
	25	250	G 1	20	20	18	42	54	30	48	36	46	340	51,40	FI-TE-25SR-W3	
	.98	3625		.79	.79	.71	1.65	2.13	1.18	1.89	1.42	1.81	251.6	113.08		
	30	160	G 1 1/4	25	25	20	49	62	35,5	54	41	50	540	79,20	FI-TE-30SR-W3	
	1.18	2320		.98	.98	.79	1.93	2.44	1.40	2.13	1.61	1.97	399.6	174.24		
	38	160	G 1 1/2	32	32	22	57	72	41	61	50	60	700	114,50	FI-TE-38SR-W3	
	1.50	2320		1.26	1.26	.87	2.24	2.83	1.61	2.40	1.97	2.36	518.0	251.90		

¹ Approximate dimension in assembled condition.

² Weight excluding cutting rings and union nuts.

³ Standard scope of delivery: Fitting body only.

Male stud acc. to DIN 3852-2 (Form B) / ISO 1179-4 (Type B)
Port acc. to DIN 3852-2 (Form X) / ISO 1179-1

Torque recommendations for Steel mating material.

Connecting Parts

-  Cutting Ring
Type **FI-DS** Page 26
-  Soft-Sealing Cutting Ring
Type **FI-WDDS** Page 27
-  Support Sleeve
Type **FI-VH** Page 28
-  STAUFF Form Ring
Type **FI-AR** Page 30
-  Union Nut
Type **FI-M** Page 31
-  37° Flared Tube Fitting Set
Type **FI-AB** Page 35



Male Stud Branch Tee
Type FI-TE-...-M • Series L / S

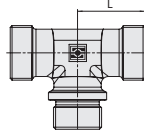
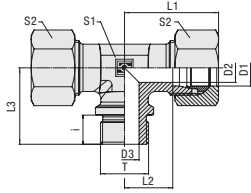

C

Metallic Sealing Edge

Metric Parallel Thread

Series	Tube OD (mm/in)	PN (bar/PSI)	Dimensions (mm/in)											Torque (Nm/ft-lb)	Weight (kg/lbs) ca. per 100 ²	Ordering Codes ³
			Thread	T	D2	D3	i	L	L1 ¹	L2	L3	S1	S2			
L	22	160	M 26 x 1,5	19	18	16	35	44	27,5	42	27	36	190	22,20	FI-TE-22LM-W3	
	.87	2320		.75	.71	.63	1.38	1.73	1.08	1.65	1.06	1.42	140.6	48.84		
	28	160	M 33 x 2	24	23	18	38	47	30,5	48	36	41	340	37,60	FI-TE-28LM-W3	
	1.10	2320		.94	.91	.71	1.50	1.85	1.20	1.89	1.42	1.61	251.6	82.72		
	35	160	M 42 x 2	30	30	20	45	56	34,5	54	41	50	500	56,90	FI-TE-35LM-W3	
	1.38	2320		1.18	1.18	.79	1.77	2.20	1.36	2.13	1.61	1.97	370.0	125.18		
42	160	M 48 x 2	36	36	22	51	63	40	61	50	60	630	81,10	FI-TE-42LM-W3		
1.65	2320		1.42	1.42	.87	2.01	2.48	1.57	2.40	1.97	2.36	466.2	178.42			
S	20	400	M 27 x 2	16	16	16	37	48	26,5	42	27	36	270	29,10	FI-TE-20SM-W3	
	.79	5800		.63	.63	.63	1.46	1.89	1.04	1.65	1.06	1.42	199.8	64.02		
	25	250	M 33 x 2	20	20	18	42	54	30	48	36	46	410	51,10	FI-TE-25SM-W3	
	.98	3625		.79	.79	.71	1.65	2.13	1.18	1.89	1.42	1.81	303.4	112.42		
	30	160	M 42 x 2	25	25	20	49	62	35,5	54	41	50	540	79,60	FI-TE-30SM-W3	
	1.18	2320		.98	.98	.79	1.93	2.44	1.40	2.13	1.61	1.97	399.6	175.12		
	38	160	M 48 x 2	32	32	22	57	72	41	61	50	60	700	115,10	FI-TE-38SM-W3	
	1.50	2320		1.26	1.26	.87	2.24	2.83	1.61	2.40	1.97	2.36	518.0	253.22		

¹ Approximate dimension in assembled condition.

² Weight excluding cutting rings and union nuts.

³ Standard scope of delivery: Fitting body only.

Male stud acc. to DIN 3852-1 (Form B) / ISO 9974-3 (Type B)

Port acc. to DIN 3852-1 (Form X) / ISO 9974-1

Torque recommendations for Steel mating material.

Ordering Codes

***FI-TE*-22*L*M*-W3*-MS**

- * Male Stud Branch Tee FI-TE
- * Outside Tube Diameter D1 (in mm) -22
- * Series L
Light Series S
Heavy Series
- * Thread Type M
Metric Parallel Thread
- If required, please indicate special sizes, e.g. M27x2!
- * Material Code -W3
Steel, zinc/nickel-plated
- Please contact STAUFF for alternative materials and surface finishings.
- * Assembling / Kitting —
Fitting body only
- Fitting body supplied with cutting rings and union nuts -MS
- Fitting body supplied with soft-sealing cutting rings and union nuts -MSV

Connecting Parts

-  Cutting Ring
Type **FI-DS** Page 26
-  Soft-Sealing Cutting Ring
Type **FI-WDDS** Page 27
-  Support Sleeve
Type **FI-VH** Page 28
-  STAUFF Form Ring
Type **FI-AR** Page 30
-  Union Nut
Type **FI-M** Page 31
-  37° Flared Tube Fitting Set
Type **FI-AB** Page 35



Male Stud Branch Tee
Type FI-TE-...-Rk ▪ Series LL / L / S

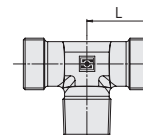
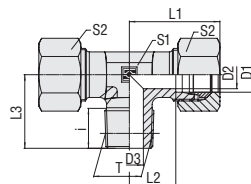

C

Whitworth Taper Pipe Thread (BSPT)

Ordering Codes

***FI-TE*-10*L*Rk*-W3*-MS**

- * Male Stud Branch Tee **FI-TE**
- * Outside Tube Diameter D1 (in mm) **-10**
- * Series **LL** Extra-Light Series
L Light Series
S Heavy Series
- * Thread Type **Rk** Whitworth Taper Pipe Thread (BSPT)
- If required, please indicate special sizes, e.g. R1/8k!
- * Material Code **-W3** Steel, zinc/nickel-plated
- Please contact STAUFF for alternative materials and surface finishings.
- * Assembling / Kitting **—** Fitting body only
-MS Fitting body supplied with cutting rings and union nuts
-MSV Fitting body supplied with soft-sealing cutting rings and union nuts

Series	Tube OD (mm/in)	PN (bar/psi)	Dimensions (mm/in)										Weight (kg/lbs) ca. per 100 ²	Ordering Codes ³
			D1	Thread	T	D2	D3	i	L	L1 ¹	L2	L3		
LL	4	100	R 1/8 keg.	3	4	8	15	21	11	17	9	10	1,59	FI-TE-04LLRk-W3
	.16	1450		.12	.16	.31	.59	.83	.43	.67	.35	.39	3,50	
	6	100	R 1/8 keg.	4,5	4,5	8	15	21	9,5	17	9	12	1,34	FI-TE-06LLRk-W3
	.24	1450		.18	.18	.31	.59	.83	.37	.67	.35	.47	2,94	
	8	100	R 1/8 keg.	6	6	8	17	23	11,5	20	12	14	1,88	FI-TE-08LLRk-W3
	.31	1450		.24	.24	.31	.67	.91	.45	.79	.47	.55	4,14	
L	6	315	R 1/8 keg.	4	4	8	19	27	12	20	12	14	2,73	FI-TE-06LRk-W3
	.24	4568		.16	.16	.31	.75	1.06	.47	.79	.47	.55	6,00	
	8	315	R 1/4 keg.	6	6	12	21	29	14	26	12	17	3,80	FI-TE-08LRk-W3
	.31	4568		.24	.24	.47	.83	1.14	.55	1.02	.47	.67	8,36	
	10	315	R 1/4 keg.	8	7	12	22	30	15	27	14	19	4,70	FI-TE-10LRk-W3
	.39	4568		.31	.28	.47	.87	1.18	.59	1.06	.55	.75	10,34	
	12	315	R 3/8 keg.	10	9	12	24	32	17	28	17	22	6,28	FI-TE-12LRk-W3
	.47	4568		.39	.35	.47	.94	1.26	.67	1.10	.67	.87	13,82	
	15	315	R 1/2 keg.	12	11	14	28	36	21	34	19	27	11,80	FI-TE-15LRk-W3
	.59	4568		.47	.43	.55	1.10	1.42	.83	1.34	.75	1.06	25,96	
	18	315	R 1/2 keg.	15	14	14	31	40	23,5	36	24	32	16,30	FI-TE-18LRk-W3
	.71	4568		.59	.55	.55	1.22	1.57	.93	1.42	.94	1.26	35,86	
S	6	400	R 1/4 keg.	4	4	12	23	31	16	26	12	17	5,00	FI-TE-06SRk-W3
	.24	5800		.16	.16	.47	.91	1.22	.63	1.02	.47	.67	11,00	
	8	400	R 1/4 keg.	5	5	12	24	32	17	27	14	19	6,27	FI-TE-08SRk-W3
	.31	5800		.20	.20	.47	.94	1.26	.67	1.06	.55	.75	13,80	
	10	400	R 3/8 keg.	7	7	12	25	34	17,5	28	17	22	8,50	FI-TE-10SRk-W3
	.39	5800		.28	.28	.47	.98	1.34	.69	1.10	.67	.87	18,70	
	12	400	R 3/8 keg.	8	8	12	29	38	21,5	28	17	24	11,60	FI-TE-12SRk-W3
	.47	5800		.31	.31	.47	1.14	1.50	.85	1.10	.67	.94	25,52	
	14	400	R 1/2 keg.	10	10	14	30	40	22	32	19	27	15,47	FI-TE-14SRk-W3
	.55	5800		.39	.39	.55	1.18	1.57	.87	1.26	.75	1.06	34,03	
	16	400	R 1/2 keg.	12	12	14	33	43	24,5	32	24	30	18,90	FI-TE-16SRk-W3
	.63	5800		.47	.47	.55	1.30	1.69	.96	1.26	.94	1.18	41,58	

Connecting Parts

- Cutting Ring
Type **FI-DS** Page 26
- Soft-Sealing Cutting Ring
Type **FI-WDDS** Page 27
- Support Sleeve
Type **FI-VH** Page 28
- STAUFF Form Ring
Type **FI-AR** Page 30
- Union Nut
Type **FI-M** Page 31
- 37° Flared Tube Fitting Set
Type **FI-AB** Page 35

¹ Approximate dimension in assembled condition.
² Weight excluding cutting rings and union nuts.
³ Standard scope of delivery: Fitting body only.

Male stud acc. to DIN 3852-2 (Form C)
Port acc. to DIN 3852-2 (Form Z)

Suitable liquid / plastic sealant required.



Male Stud Branch Tee
Type FI-TE-...-Mk ■ Series LL / L / S

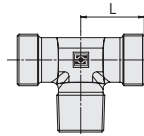
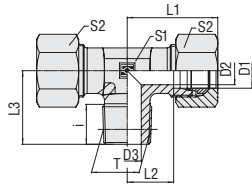

Metric Taper Thread

Series	Tube OD (mm/in)	PN (bar/PSI)	Dimensions (mm/in)										Weight (kg/lbs) ca. per 100 ²	Ordering Codes ³	
			Thread	T	D2	D3	i	L	L ¹	L2	L3	S1			S2
LL	4	100	M 8 x 1 keg.	3	3,5	8	15	21	11	17	9	10	1,27	FI-TE-04LLMk-W3	
	.16	1450		.12	.14	.31	.59	.83	.43	.67	.35	.39	2,79		
	6	100	M 10 x 1 keg.	4,5	4,5	8	15	21	9,5	17	9	12	1,62	FI-TE-06LLMk-W3	
	.24	1450		.18	.18	.31	.59	.83	.37	.67	.35	.47	3,56		
L	8	100	M 10 x 1 keg.	6	6	8	17	23	11,5	20	12	14	2,42	FI-TE-08LLMk-W3	
	.31	1450		.24	.24	.31	.67	.91	.45	.79	.47	.55	5,31		
L	6	315	M 10 x 1 keg.	4	4	8	19	27	12	20	12	14	2,76	FI-TE-06LMk-W3	
	.24	4568		.16	.16	.31	.75	1.06	.47	.79	.47	.55	6,08		
	8	315	M 12 x 1,5 keg.	6	6	12	21	29	14	26	12	17	3,45	FI-TE-08LMk-W3	
	.31	4568		.24	.24	.47	.83	1.14	.55	1.02	.47	.67	7,59		
	10	315	M 14 x 1,5 keg.	8	7	12	22	30	15	27	14	19	4,72	FI-TE-10LMk-W3	
	.39	4568		.31	.28	.47	.87	1.18	.59	1.06	.55	.75	10,38		
	12	315	M 16 x 1,5 keg.	10	9	12	24	32	17	28	17	22	7,19	FI-TE-12LMk-W3	
	.47	4568		.39	.35	.47	.94	1.26	.67	1.10	.67	.87	15,81		
	15	315	M 18 x 1,5 keg.	12	11	12	28	36	21	32	19	27	11,86	FI-TE-15LMk-W3	
	.59	4568		.47	.43	.47	1.10	1.42	.83	1.26	.75	1.06	26,10		
	18	315	M 22 x 1,5 keg.	15	14	14	31	40	23,5	36	24	32	17,50	FI-TE-18LMk-W3	
	.71	4568		.59	.55	.55	1.22	1.57	.93	1.42	.94	1.26	38,49		
	S	6	400	M 12 x 1,5 keg.	4	4	12	23	31	16	26	12	17	5,57	FI-TE-06SMk-W3
		.24	5800		.16	.16	.47	.91	1.22	.63	1.02	.47	.67	12,26	
		8	400	M 14 x 1,5 keg.	5	5	12	24	32	17	27	14	19	7,54	FI-TE-08SMk-W3
		.31	5800		.20	.20	.47	.94	1.26	.67	1.06	.55	.75	16,58	
10		400	M 16 x 1,5 keg.	7	7	12	25	34	17,5	28	17	22	9,38	FI-TE-10SMk-W3	
.39		5800		.28	.28	.47	.98	1.34	.69	1.10	.67	.87	20,64		
12		400	M 18 x 1,5 keg.	8	8	12	29	38	21,5	28	17	24	10,71	FI-TE-12SMk-W3	
.47		5800		.31	.31	.47	1.14	1.50	.85	1.10	.67	.94	23,56		
14		400	M 20 x 1,5 keg.	10	10	14	30	40	22	32	19	27	15,11	FI-TE-14SMk-W3	
.55		5800		.39	.39	.55	1.18	1.57	.87	1.26	.75	1.06	33,25		
16		400	M 22 x 1,5 keg.	12	12	14	33	43	24,5	32	24	30	20,16	FI-TE-16SMk-W3	
.63		5800		.47	.47	.55	1.30	1.69	.96	1.26	.94	1.18	44,35		

¹ Approximate dimension in assembled condition.
² Weight excluding cutting rings and union nuts.
³ Standard scope of delivery: Fitting body only.

Male stud acc. to DIN 3852-1 (Form C)
 Port acc. to DIN 3852-1 (Form Z)

Suitable liquid / plastic sealant required.

Ordering Codes

***FI-TE*-10*L*Mk*-W3*-MS**

- * Male Stud Branch Tee **FI-TE**
- * Outside Tube Diameter D1 (in mm) **-10**
- * Series **LL** (Extra-Light Series)
L (Light Series)
S (Heavy Series)
- * Thread Type **Mk** (Metric Taper Thread)

If required, please indicate special sizes, e.g. M12x1.5 !

- * Material Code **-W3** (Steel, zinc/nickel-plated)

Please contact STAUFF for alternative materials and surface finishings.

- * Assembling / Kitting **—** (Fitting body only)
- MS** (Fitting body supplied with cutting rings and union nuts)
- MSV** (Fitting body supplied with soft-sealing cutting rings and union nuts)

Connecting Parts

- Cutting Ring Type **FI-DS** Page 26
- Soft-Sealing Cutting Ring Type **FI-WDDS** Page 27
- Support Sleeve Type **FI-VH** Page 28
- STAUFF Form Ring Type **FI-AR** Page 30
- Union Nut Type **FI-M** Page 31
- 37° Flared Tube Fitting Set Type **FI-AB** Page 35



Male Stud Branch Tee
Type FI-TE-...-N • Series LL / L

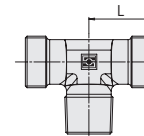
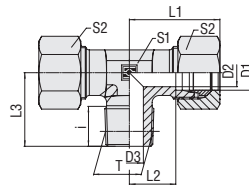

C

NPT-Thread

Ordering Codes

***FI-TE*-10*L*1/4N*-W3*-MS**

- * Male Stud Branch Tee **FI-TE**
- * Outside Tube Diameter D1 (in mm) **-10**
- * Series **LL** Extra-Light Series (page 72)
L Light Series (page 72)
S Heavy Series (page 73)
- * Thread Size **1/4** acc. to dimension table
- Please always indicate thread sizes, e.g. 1/4!
- * Thread Type **N** NPT Thread
- * Material Code **-W3** Steel, zinc/nickel-plated
- Please contact STAUFF for alternative materials and surface finishings.
- * Assembling / Kitting **—** Fitting body only
- MS** Fitting body supplied with cutting rings and union nuts
- MSV** Fitting body supplied with soft-sealing cutting rings and union nuts

Series	Tube OD (mm/in)	PN (°B/PS)	Dimensions (mm/in)											Weight (kg/lbs) Ca. per 100 ²	Ordering Codes ³
			Thread	T	D2	D3	i	L	L1 ¹	L2	L3	S1	S2		
LL	4	100	1/8 NPT	3	3	7	15	21	11	17	9	10	1,60	FI-TE-04LL1/8N-W3	
	.16	1450		.12	.12	.28	.59	.83	.43	.67	.35	.39	3.52		
	6	100	1/8 NPT	4,5	4,5	7	15	21	9,5	17	9	12	1,50	FI-TE-06LL1/8N-W3	
	.24	1450		.18	.18	.28	.59	.83	.37	.67	.35	.47	3.30		
LL	8	100	1/8 NPT	5	5	7	17	23	11,5	20	12	14	2,50	FI-TE-08LL1/8N-W3	
	.31	1450		.20	.20	.28	.67	.91	.45	.79	.47	.55	5.50		
	L	6	315	1/8 NPT	4	4	7	19	27	12	20	12	14	3,00	FI-TE-06L1/8N-W3
		.24	4568		.16	.16	.28	.75	1.06	.47	.79	.47	.55	6.60	
6		315	1/4 NPT	4	4	10	21	29	14	26	12	14	4,40	FI-TE-06L1/4N-W3	
.24		4568		.16	.16	.39	.83	1.14	.55	1.02	.47	.55	9.68		
8		315	1/4 NPT	6	6	10	21	29	14	26	12	17	4,20	FI-TE-08L1/4N-W3	
.31		4568		.24	.24	.39	.83	1.14	.55	1.02	.47	.67	9.24		
10		315	1/4 NPT	7	7	10	22	30	15	27	14	19	5,00	FI-TE-10L1/4N-W3	
.39		4568		.28	.28	.39	.87	1.18	.59	1.06	.55	.75	11.00		
12		315	3/8 NPT	10	10	10,5	24	32	17	28	17	22	6,50	FI-TE-12L3/8N-W3	
.47		4568		.39	.39	.41	.94	1.26	.67	1.10	.67	.87	14.30		
15		315	1/2 NPT	12	12	14	28	36	21	36	19	27	12,10	FI-TE-15L1/2N-W3	
.59		4568		.47	.47	.55	1.10	1.42	.83	1.42	.75	1.06	26.62		
18		315	1/2 NPT	15	12	14	31	40	23,5	36	24	32	16,30	FI-TE-18L1/2N-W3	
.71		4568		.59	.47	.55	1.22	1.57	.93	1.42	.94	1.26	35.86		
22		160	3/4 NPT	19	18	14	35	44	27,5	42	27	36	21,80	FI-TE-22L3/4N-W3	
.87		2320		.75	.71	.55	1.38	1.73	1.08	1.65	1.06	1.42	47.96		
28	160	1 NPT	24	21	17,5	38	47	30,5	48	36	41	39,00	FI-TE-28L1N-W3		
1.10	2320		.94	.83	.69	1.50	1.85	1.20	1.89	1.42	1.61	85.80			
35	160	1 1/4 NPT	30	28	18	46	57	35,5	54	41	50	59,40	FI-TE-35L1-1/4N-W3		
1.38	2320		1.18	1.10	.71	1.81	2.24	1.40	2.13	1.61	1.97	130.68			
42	160	1 1/2 NPT	36	34	18,5	51	63	40	61	50	60	84,10	FI-TE-42L1-1/2N-W3		
1.65	2320		1.42	1.34	.73	2.01	2.48	1.57	2.40	1.97	2.36	185.02			

Connecting Parts

- Cutting Ring
Type **FI-DS** Page 26
- Soft-Sealing Cutting Ring
Type **FI-WDDS** Page 27
- Support Sleeve
Type **FI-VH** Page 28
- STAUFF Form Ring
Type **FI-AR** Page 30
- Union Nut
Type **FI-M** Page 31
- 37° Flared Tube Fitting Set
Type **FI-AB** Page 35

¹ Approximate dimension in assembled condition.

² Weight excluding cutting rings and union nuts.

³ Standard scope of delivery: Fitting body only.

Male stud acc. to ANSI/ASME B1.20.1-1983

Port acc. to ANSI/ASME B1.20.1-1983

Suitable liquid / plastic sealant required.



Male Stud Branch Tee
Type FI-TE-...-N • Series S

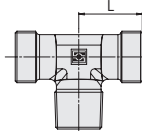
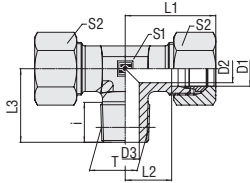

NPT Thread

Series	Tube OD PN		Dimensions											Weight (^{kg} / _{lbs}) ca. per 100 ²	Ordering Codes ³
	(mm/in)	(bar/psi)	Thread	T	D2	D3	i	L	L1 ¹	L2	L3	S1	S2		
S	6	630	1/4 NPT	4	4	10	23	31	16	26	12	17	5,50	FI-TE-06S1/4N-W3	
	.24	9135		.16	.16	.39	.91	1.22	.63	1.02	.47	.67	12.10		
	8	630	1/4 NPT	5	5	10	24	32	17	27	14	19	6,80	FI-TE-08S1/4N-W3	
	.31	9135		.20	.20	.39	.94	1.26	.67	1.06	.55	.75	14.96		
	10	630	3/8 NPT	7	7	10,5	25	34	17,5	28	17	22	8,80	FI-TE-10S3/8N-W3	
	.39	9135		.28	.28	.41	.98	1.34	.69	1.10	.67	.87	19.36		
	12	630	3/8 NPT	8	8	10,5	29	38	21,5	28	22	24	11,10	FI-TE-12S3/8N-W3	
	.47	9135		.31	.31	.41	1.14	1.50	.85	1.10	.87	.94	24.42		
	14	630	1/2 NPT	10	10	14	30	40	22	34	19	27	15,10	FI-TE-14S1/2N-W3	
	.55	9135		.39	.39	.55	1.18	1.57	.87	1.34	.75	1.06	33.22		
	16	630	1/2 NPT	12	12	14	33	43	24,5	36	24	30	19,00	FI-TE-16S1/2N-W3	
	.63	9135		.47	.47	.55	1.30	1.69	.96	1.42	.94	1.18	41.80		
	20	400	3/4 NPT	16	16	14	37	48	26,5	42	27	36	28,20	FI-TE-20S3/4N-W3	
	.79	5800		.63	.63	.55	1.46	1.89	1.04	1.65	1.06	1.42	62.04		
	25	400	1 NPT	20	20	17,5	42	54	30	48	36	46	50,40	FI-TE-25S1N-W3	
	.98	5800		.79	.79	.69	1.65	2.13	1.18	1.89	1.42	1.81	110.88		
	30	400	1 1/4 NPT	25	25	18	49	62	35,5	54	41	50	78,20	FI-TE-30S1-1/4N-W3	
	1.18	5800		.98	.98	.71	1.93	2.44	1.40	2.13	1.61	1.97	172.04		
	38	400	1 1/2 NPT	32	32	18,5	57	72	41	61	50	60	113,30	FI-TE-38S1-1/2N-W3	
	1.50	5800		1.26	1.26	.73	2.24	2.83	1.61	2.40	1.97	2.36	249.26		

¹ Approximate dimension in assembled condition.
² Weight excluding cutting rings and union nuts.
³ Standard scope of delivery: Fitting body only.

Male stud acc. to ANSI/ASME B1.20.1-1983
 Port acc. to ANSI/ASME B1.20.1-1983
 Suitable liquid / plastic sealant required.

Ordering Codes

***FI-TE*-10*L*1/4N*-W3*-MS**

* Male Stud Branch Tee	FI-TE
* Outside Tube Diameter D1 (in mm)	-10
* Series	Extra-Light Series (page 72) LL Light Series (page 72) L Heavy Series (page 73) S
* Thread Size	acc. to dimension table 1/4
Please always indicate thread sizes, e.g. 1/4!	
* Thread Type	NPT Thread N
* Material Code	Steel, zinc/nickel-plated -W3
Please contact STAUFF for alternative materials and surface finishings.	
* Assembling / Kitting	Fitting body only —
	Fitting body supplied with cutting rings and union nuts -MS
	Fitting body supplied with soft-sealing cutting rings and union nuts -MSV

Connecting Parts

	Cutting Ring Type FI-DS	Page 26
	Soft-Sealing Cutting Ring Type FI-WDDS	Page 27
	Support Sleeve Type FI-VH	Page 28
	STAUFF Form Ring Type FI-AR	Page 30
	Union Nut Type FI-M	Page 31
	37° Flared Tube Fitting Set Type FI-AB	Page 35



Male Stud Barrel Tee
Type FI-LE-...-R • Series L / S

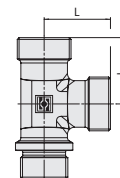
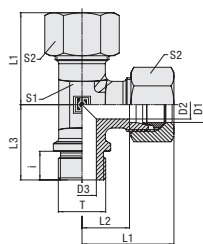

C

Whitworth Parallel Pipe Thread (BSPP)

Metallic Sealing Edge

Ordering Codes

***FI-LE*-22*L*R*-W3*-MS**

- * Male Stud Barrel Tee **FI-LE**
- * Outside Tube Diameter D1 (in mm) **-22**
- * Series **L**
Light Series
Heavy Series **S**
- * Thread Type **R**
Whitworth Parallel
Pipe Thread (BSPP)
- If required, please indicate special sizes, e.g. R1/2!
- * Material Code **-W3**
Steel, zinc/nickel-plated
- Please contact STAUFF for alternative materials and surface finishings.
- * Assembling / Kitting **—**
Fitting body only
- Fitting body supplied with cutting rings and union nuts **-MS**
- Fitting body supplied with soft-sealing cutting rings and union nuts **-MSV**

Series	Tube OD (mm/in)	PN (bar/psi)	Dimensions (mm/in)											Torque (N·m/ft·lb)	Weight (kg/lbs) ca. per 100 ²	Ordering Codes ³
			D1	Thread	T	D2	D3	i	L	L1 ¹	L2	L3	S1			
L	22	160	G 3/4	18	18	16	35	44	27,5	42	27	36	180	25,01	FI-LE-22LR-W3	
	.87	2320		.71	.71	.63	1.38	1.73	1.08	1.65	1.06	1.42	133.2	55.01		
	28	160	G 1	23	23	18	38	47	30,5	48	36	41	330	40,60	FI-LE-28LR-W3	
	1.10	2320		.91	.91	.71	1.50	1.85	1.20	1.89	1.42	1.61	244.2	89.32		
	35	160	G 1 1/4	30	30	20	45	56	34,5	54	41	50	540	61,96	FI-LE-35LR-W3	
	1.38	2320		1.18	1.18	.79	1.77	2.20	1.36	2.13	1.61	1.97	399.6	136.32		
S	42	160	G 1 1/2	36	36	22	51	63	40	61	50	60	630	100,41	FI-LE-42LR-W3	
	1.65	2320		1.42	1.42	.87	2.01	2.48	1.57	2.40	1.97	2.36	466.2	220.90		
	20	400	G 3/4	16	16	16	37	48	26,5	42	27	36	270	31,72	FI-LE-20SR-W3	
	.79	5800		.63	.63	.63	1.46	1.89	1.04	1.65	1.06	1.42	199.8	69.78		
	25	250	G 1	20	20	18	42	54	30	48	36	46	340	54,62	FI-LE-25SR-W3	
	.98	3625		.79	.79	.71	1.65	2.13	1.18	1.89	1.42	1.81	251.6	120.16		
S	30	160	G 1 1/4	25	25	20	49	62	35,5	54	41	50	540	52,00	FI-LE-30SR-W3	
	1.18	2320		.98	.98	.79	1.93	2.44	1.40	2.13	1.61	1.97	399.6	114.40		
	38	160	G 1 1/2	32	32	22	57	72	41	61	50	60	700	134,44	FI-LE-38SR-W3	
	1.50	2320		1.26	1.26	.87	2.24	2.83	1.61	2.40	1.97	2.36	518.0	295.76		

¹ Approximate dimension in assembled condition.

² Weight excluding cutting rings and union nuts.

³ Standard scope of delivery: Fitting body only.

Male stud acc. to DIN 3852-2 (Form B) / ISO 1179-4 (Type B)
Port acc. to DIN 3852-2 (Form X) / ISO 1179-1

Torque recommendations for Steel mating material.

Connecting Parts

- Cutting Ring
Type **FI-DS** Page 26
- Soft-Sealing Cutting Ring
Type **FI-WDDS** Page 27
- Support Sleeve
Type **FI-VH** Page 28
- STAUFF Form Ring
Type **FI-AR** Page 30
- Union Nut
Type **FI-M** Page 31
- 37° Flared Tube Fitting Set
Type **FI-AB** Page 35



Male Stud Barrel Tee
Type FI-LE-...-M • Series L / S

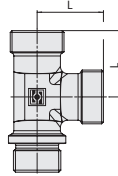
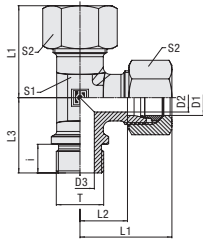

C

Metallic Sealing Edge

Metric Parallel Thread

Series	Tube OD (mm/in)	PN (bar/PSI)	Dimensions (mm/in)											Torque (Nm/ft-lb)	Weight (kg/lbs) ca. per 100 ²	Ordering Codes ³
			Thread	T	D2	D3	i	L	L1 ¹	L2	L3	S1	S2			
L	22	160	M 26 x 1,5	18	18	16	35	44	27,5	42	27	36	190	25,01	FI-LE-22LM-W3	
	.87	2320		.71	.71	.63	1.38	1.73	1.08	1.65	1.06	1.42	140.6	55.01		
	28	160	M 33 x 2	23	23	18	38	47	30,5	48	27	41	340	40,60	FI-LE-28LM-W3	
	1.10	2320		.91	.91	.71	1.50	1.85	1.20	1.89	1.06	1.61	251.6	89.32		
	35	160	M 42 x 2	30	30	20	45	56	34,5	54	41	50	500	61,96	FI-LE-35LM-W3	
	1.38	2320		1.18	1.18	.79	1.77	2.20	1.36	2.13	1.61	1.97	370.0	136.32		
42	160	M 48 x 2	36	36	22	51	63	40	61	50	60	630	100,41	FI-LE-42LM-W3		
1.65	2320		1.42	1.42	.87	2.01	2.48	1.57	2.40	1.97	2.36	466.2	220.90			
S	20	400	M 27 x 2	16	16	16	37	48	26,5	42	27	36	270	31,72	FI-LE-20SM-W3	
	.79	5800		.63	.63	.63	1.46	1.89	1.04	1.65	1.06	1.42	199.8	69.78		
	25	250	M 33 x 2	20	20	18	42	54	30	48	36	46	410	54,62	FI-LE-25SM-W3	
	.98	3625		.79	.79	.71	1.65	2.13	1.18	1.89	1.42	1.81	303.4	120.16		
	30	160	M 42 x 2	25	25	20	49	62	35,5	54	41	50	540	52,00	FI-LE-30SM-W3	
	1.18	2320		.98	.98	.79	1.93	2.44	1.40	2.13	1.61	1.97	399.6	114.40		
	38	160	M 48 x 2	32	32	22	57	72	41	61	50	60	700	134,44	FI-LE-38SM-W3	
1.50	2320	1.26		1.26	.87	2.24	2.83	1.61	2.40	1.97	2.36	518.0	295.76			

¹ Approximate dimension in assembled condition.
² Weight excluding cutting rings and union nuts.
³ Standard scope of delivery: Fitting body only.

Male stud acc. to DIN 3852-1 (Form B) / ISO 9974-3 (Type B)
 Port acc. to DIN 3852-1 (Form X) / ISO 9974-1
 Torque recommendations for Steel mating material.

Ordering Codes

***FI-LE*-22*L*M*-W3*-MS**

- * Male Stud Barrel Tee FI-LE
- * Outside Tube Diameter D1 (in mm) -22
- * Series L
Light Series S
Heavy Series
- * Thread Type M
Metric Parallel Thread
- If required, please indicate special sizes, e.g. M27x2!
- * Material Code -W3
Steel, zinc/nickel-plated
- Please contact STAUFF for alternative materials and surface finishings.
- * Assembling / Kitting —
Fitting body only
- Fitting body supplied with cutting rings and union nuts -MS
- Fitting body supplied with soft-sealing cutting rings and union nuts -MSV

Connecting Parts

-  Cutting Ring
Type **FI-DS** Page 26
-  Soft-Sealing Cutting Ring
Type **FI-WDDS** Page 27
-  Support Sleeve
Type **FI-VH** Page 28
-  STAUFF Form Ring
Type **FI-AR** Page 30
-  Union Nut
Type **FI-M** Page 31
-  37° Flared Tube Fitting Set
Type **FI-AB** Page 35



Male Stud Barrel Tee
Type FI-LE-...-Rk ▪ Series LL / L / S

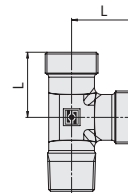
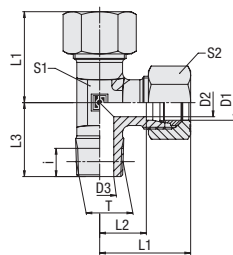

C

Whitworth Taper Pipe Thread (BSPT)

Ordering Codes

***FI-LE*-10*L*Rk*-W3*-MS**

- * Male Stud Barrel Tee **FI-LE**
- * Outside Tube Diameter D1 (in mm) **-10**
- * Series **LL**
 Extra-Light Series
 Light Series **L**
 Heavy Series **S**
- * Thread Type **Rk**
 Whitworth Taper
 Pipe Thread (BSPT)
- If required, please indicate special sizes, e.g. R1/8k!
- * Material Code **-W3**
 Steel, zinc/nickel-plated
- * Assembling / Kitting **—**
 Fitting body only
 Fitting body supplied with
 cutting rings and union nuts **-MS**
 Fitting body supplied with
 soft-sealing cutting rings
 and union nuts **-MSV**

Series	Tube OD (mm/in)	PN (bar/psi)	Dimensions (mm/in)											Weight (kg/lbs) ca. per 100 ²	Ordering Codes ³
			D1	Thread T	D2	D3	i	L	L1 ¹	L2	L3	S1	S2		
LL	4	100	R 1/8 keg.	3	4	8	15	21	11	17	9	10	1,50	FI-LE-04LLRk-W3	
	.16	1450		.12	.16	.31	.59	.83	.43	.67	.35	.39	3,30		
	6	100	R 1/8 keg.	4,5	5	8	16	21	9,5	17	9	12	1,60	FI-LE-06LLRk-W3	
	.24	1450		.18	.20	.31	.63	.83	.37	.67	.35	.47	3,52		
	8	100	R 1/8 keg.	6	6	8	17	23	11,5	20	12	14	2,42	FI-LE-08LLRk-W3	
	.31	1450		.24	.24	.31	.67	.91	.45	.79	.47	.55	5,31		
L	6	315	R 1/8 keg.	4	4	8	19	27	12	20	12	14	3,43	FI-LE-06LRk-W3	
	.24	4568		.16	.16	.31	.75	1.06	.47	.79	.47	.55	94,60		
	8	315	R 1/4 keg.	6	6	12	21	29	14	26	12	17	3,79	FI-LE-08LRk-W3	
	.31	4568		.24	.24	.47	.83	1.14	.55	1.02	.47	.67	8,34		
	10	315	R 1/4 keg.	8	7	12	22	30	15	27	14	19	5,20	FI-LE-10LRk-W3	
	.39	4568		.31	.28	.47	.87	1.18	.59	1.06	.55	.75	11,44		
	12	315	R 3/8 keg.	10	9	12	24	32	17	28	17	22	6,34	FI-LE-12LRk-W3	
	.47	4568		.39	.35	.47	.94	1.26	.67	1.10	.67	.87	13,95		
	15	315	R 1/2 keg.	12	11	14	28	36	21	34	19	27	11,50	FI-LE-15LRk-W3	
	.59	4568		.47	.43	.55	1.10	1.42	.83	1.34	.75	1.06	25,30		
	18	315	R 1/2 keg.	15	14	14	31	40	23,5	36	24	32	14,48	FI-LE-18LRk-W3	
	.71	4568		.59	.55	.55	1.22	1.57	.93	1.42	.94	1.26	31,86		
	S	6	400	R 1/4 keg.	4	4	12	23	31	16	26	12	17	5,03	FI-LE-06SRk-W3
		.24	5800		.16	.16	.47	.91	1.22	.63	1.02	.47	.67	11,07	
		8	400	R 1/4 keg.	5	5	12	24	32	17	27	14	19	6,41	FI-LE-08SRk-W3
		.31	5800		.20	.20	.47	.94	1.26	.67	1.06	.55	.75	14,10	
		10	400	R 3/8 keg.	7	7	12	25	34	17,5	28	17	22	8,33	FI-LE-10SRk-W3
		.39	5800		.28	.28	.47	.98	1.34	.69	1.10	.67	.87	18,33	
12		400	R 3/8 keg.	8	8	12	29	38	21,5	28	17	24	10,46	FI-LE-12SRk-W3	
.47		5800		.31	.31	.47	1.14	1.50	.85	1.10	.67	.94	23,00		
14		400	R 1/2 keg.	10	10	14	30	40	22	32	19	27	13,91	FI-LE-14SRk-W3	
.55		5800		.39	.39	.55	1.18	1.57	.87	1.26	.75	1.06	30,60		
16		400	R 1/2 keg.	12	12	14	33	43	24,5	32	24	30	17,66	FI-LE-16SRk-W3	
.63		5800		.47	.47	.55	1.30	1.69	.96	1.26	.94	1.18	38,85		

Connecting Parts

-  Cutting Ring
Type **FI-DS** Page 26
-  Soft-Sealing Cutting Ring
Type **FI-WDDS** Page 27
-  Support Sleeve
Type **FI-VH** Page 28
-  STAUFF Form Ring
Type **FI-AR** Page 30
-  Union Nut
Type **FI-M** Page 31
-  37° Flared Tube Fitting Set
Type **FI-AB** Page 35

¹ Approximate dimension in assembled condition.
² Weight excluding cutting rings and union nuts.
³ Standard scope of delivery: Fitting body only.

Male stud acc. to DIN 3852-2 (Form C)
 Port acc. to DIN 3852-2 (Form Z)

Suitable liquid / plastic sealant required.



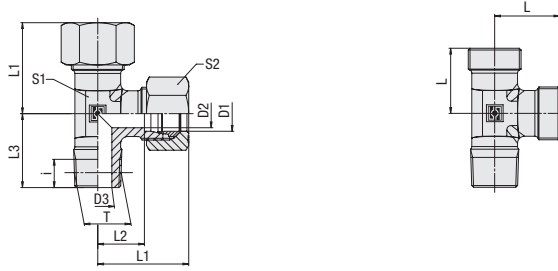

Male Stud Barrel Tee
Type FI-LE-...-Mk ■ Series LL / L / S



C

Metric Taper Thread

Series	Tube OD (mm/in)	PN (bar/PSI)	Dimensions (mm/in)										Weight (kg/lbs) ca. per 100 ²	Ordering Codes ³
			Thread	T	D2	D3	i	L	L1 ¹	L2	L3	S1		
LL	4	100	M 8 x 1 keg.	3	3,5	8	15	21	11	17	9	10	1,50	FI-LE-04LLMk-W3
	.16	1450		.12	.14	.31	.59	.83	.43	.67	.35	.39	3,30	
	6	100	M 10 x 1 keg.	4,5	4,5	8	15	21	9,5	17	9	12	1,62	FI-LE-06LLMk-W3
	.24	1450		.18	.18	.31	.59	.83	.37	.67	.35	.47	3,56	
	8	100	M 10 x 1 keg.	6	6	8	17	23	11,5	20	12	14	2,42	FI-LE-08LLMk-W3
.31	1450		.24	.24	.31	.67	.91	.45	.79	.47	.55	5,31		
L	6	315	M 10 x 1 keg.	4	4	8	19	27	12	20	12	14	3,43	FI-LE-06LMk-W3
	.24	4568		.16	.16	.31	.75	1.06	.47	.79	.47	.55	7,54	
	8	315	M 12 x 1,5 keg.	6	6	12	21	29	14	26	12	17	4,24	FI-LE-08LMk-W3
	.31	4568		.24	.24	.47	.83	1.14	.55	1.02	.47	.67	9,34	
	10	315	M 14 x 1,5 keg.	8	7	12	22	30	15	27	14	19	5,57	FI-LE-10LMk-W3
	.39	4568		.31	.28	.47	.87	1.18	.59	1.06	.55	.75	12,25	
	12	315	M 16 x 1,5 keg.	10	9	12	24	32	17	28	17	22	7,19	FI-LE-12LMk-W3
	.47	4568		.39	.35	.47	.94	1.26	.67	1.10	.67	.87	15,81	
	15	315	M 18 x 1,5 keg.	12	11	12	28	36	21	32	19	27	11,86	FI-LE-15LMk-W3
	.59	4568		.47	.43	.47	1.10	1.42	.83	1.26	.75	1.06	26,10	
	18	315	M 22 x 1,5 keg.	15	14	14	31	40	23,5	36	24	32	17,50	FI-LE-18LMk-W3
	.71	4568		.59	.55	.55	1.22	1.57	.93	1.42	.94	1.26	38,49	
	S	6	400	M 12 x 1,5 keg.	4	4	12	23	31	16	26	12	17	5,57
.24		5800		.16	.16	.47	.91	1.22	.63	1.02	.47	.67	12,26	
8		400	M 14 x 1,5 keg.	5	5	12	24	32	17	27	14	19	7,54	FI-LE-08SMk-W3
.31		5800		.20	.20	.47	.94	1.26	.67	1.06	.55	.75	16,58	
10		400	M 16 x 1,5 keg.	7	7	12	25	34	17,5	28	17	22	8,37	FI-LE-10SMk-W3
.39		5800		.28	.28	.47	.98	1.34	.69	1.10	.67	.87	18,42	
12		400	M 18 x 1,5 keg.	8	8	12	29	38	21,5	28	17	24	12,07	FI-LE-12SMk-W3
.47		5800		.31	.31	.47	1.14	1.50	.85	1.10	.67	.94	26,55	
14		400	M 20 x 1,5 keg.	10	10	14	30	40	22	32	19	27	15,11	FI-LE-14SMk-W3
.55		5800		.39	.39	.55	1.18	1.57	.87	1.26	.75	1.06	33,25	
16		400	M 22 x 1,5 keg.	12	12	14	33	43	24,5	32	24	30	20,16	FI-LE-16SMk-W3
.63	5800		.47	.47	.55	1.30	1.69	.96	1.26	.94	1.18	44,35		

¹ Approximate dimension in assembled condition.
² Weight excluding cutting rings and union nuts.
³ Standard scope of delivery: Fitting body only.

Male stud acc. to DIN 3852-1 (Form C)
 Port acc. to DIN 3852-1 (Form Z)

Suitable liquid / plastic sealant required.

Ordering Codes

***FI-LE*-10*L*Mk*-W3*-MS**

- * Male Stud Barrel Tee **FI-LE**
- * Outside Tube Diameter D1 (in mm) **-10**
- * Series
 - Extra-Light Series **LL**
 - Light Series **L**
 - Heavy Series **S**
- * Thread Type Metric Taper Thread **Mk**

If required, please indicate special sizes, e.g. M12x1.5 !

- * Material Code Steel, zinc/nickel-plated **-W3**

Please contact STAUFF for alternative materials and surface finishings.

- * Assembling / Kitting
 - Fitting body only **—**
 - Fitting body supplied with cutting rings and union nuts **-MS**
 - Fitting body supplied with soft-sealing cutting rings and union nuts **-MSV**

Connecting Parts

- Cutting Ring Type **FI-DS** Page 26
- Soft-Sealing Cutting Ring Type **FI-WDDS** Page 27
- Support Sleeve Type **FI-VH** Page 28
- STAUFF Form Ring Type **FI-AR** Page 30
- Union Nut Type **FI-M** Page 31
- 37° Flared Tube Fitting Set Type **FI-AB** Page 35



Male Stud Barrel Tee
Type FI-LE-...-N • Series LL / L

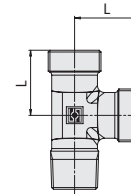
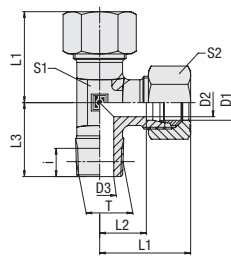

C

NPT-Thread

Ordering Codes

***FI-LE*-10*L*1/4N*-W3*-MS**

- * Male Stud Barrel Tee **FI-LE**
- * Outside Tube Diameter D1 (in mm) **-10**
- * Series **LL**
 Extra-Light Series (page 78)
 Light Series (page 78)
 Heavy Series (page 79) **L**
S
- * Thread Size **1/4**
 acc. to dimension table
 Please always indicate thread sizes, e.g. 1/4!
- * Thread Type **N**
 NPT Thread
- * Material Code **-W3**
 Steel, zinc/nickel-plated
 Please contact STAUFF for alternative materials and surface finishings.
- * Assembling / Kitting **—**
 Fitting body only
 Fitting body supplied with cutting rings and union nuts **-MS**
 Fitting body supplied with soft-sealing cutting rings and union nuts **-MSV**

Series	Tube OD (mm/in)	PN (PSI/PS)	Dimensions (mm/in)											Weight (kg/lbs) Ca. per 100 ²	Ordering Codes ³
			D1	Thread	T	D2	D3	i	L	L1 ¹	L2	L3	S1		
LL	4	100	1/8 NPT	3	3	7	15	21	11	15	9	10	1,51	FI-LE-04LL1/8N-W3	
	.16	1450		.12	.12	.28	.59	.83	.43	.59	.35	.39	3,32		
	6	100	1/8 NPT	4,5	4,5	7	15	21	9,5	15	10	12	1,62	FI-LE-06LL1/8N-W3	
	.24	1450		.18	.18	.28	.59	.83	.37	.59	.39	.47	3,56		
LL	8	100	1/8 NPT	5	5	7	17	23	11,5	20	12	14	3,30	FI-LE-08LL1/8N-W3	
	.31	1450		.20	.20	.28	.67	.91	.45	.79	.47	.55	7,26		
	L	6	315	1/8 NPT	4	4	7	19	27	12	20	12	14	1,30	FI-LE-06L1/8N-W3
		.24	4568		.16	.16	.28	.75	1.06	.47	.79	.47	.55	2,86	
8		315	1/4 NPT	6	6	10	21	29	14	26	12	17	4,24	FI-LE-08L1/4N-W3	
.31		4568		.24	.24	.39	.83	1.14	.55	1.02	.47	.67	9,33		
10		315	1/4 NPT	7	7	10	22	30	15	27	14	19	5,57	FI-LE-10L1/4N-W3	
.39		4568		.28	.28	.39	.87	1.18	.59	1.06	.55	.75	12,25		
12		315	3/8 NPT	10	10	10,5	24	32	17	28	17	22	7,19	FI-LE-12L3/8N-W3	
.47		4568		.39	.39	.41	.94	1.26	.67	1.10	.67	.87	15,81		
15		315	1/2 NPT	12	12	14	28	36	21	34	19	27	11,86	FI-LE-15L1/2N-W3	
.59		4568		.47	.47	.55	1.10	1.42	.83	1.34	.75	1.06	26,10		
18		315	1/2 NPT	14	14	14	31	40	23,5	36	24	32	17,50	FI-LE-18L1/2N-W3	
.71		4568		.55	.55	.55	1.22	1.57	.93	1.42	.94	1.26	38,49		
22		160	3/4 NPT	18	18	14	35	44	27,5	42	27	36	27,60	FI-LE-22L3/4N-W3	
.87		2320		.71	.71	.55	1.38	1.73	1.08	1.65	1.06	1.42	60,72		
28		160	1 NPT	24	24	17,5	38	47	30,5	48	36	41	43,00	FI-LE-28L1N-W3	
1.10		2320		.94	.94	.69	1.50	1.85	1.20	1.89	1.42	1.61	94,60		
35	160	1 1/4 NPT	30	30	18	46	57	35,5	54	41	50	63,50	FI-LE-35L1-1/4N-W3		
1.38	2320		1.18	1.18	.71	1.81	2.24	1.40	2.13	1.61	1.97	139,70			
42	160	1 1/2 NPT	36	36	18	51	63	40	61	50	60	110,00	FI-LE-42L1-1/2N-W3		
1.65	2320		1.42	1.42	.71	2.01	2.48	1.57	2.40	1.97	2.36	242,00			

Connecting Parts

-  Cutting Ring
Type **FI-DS** Page 26
-  Soft-Sealing Cutting Ring
Type **FI-WDDS** Page 27
-  Support Sleeve
Type **FI-VH** Page 28
-  STAUFF Form Ring
Type **FI-AR** Page 30
-  Union Nut
Type **FI-M** Page 31
-  37° Flared Tube Fitting Set
Type **FI-AB** Page 35

¹ Approximate dimension in assembled condition.

² Weight excluding cutting rings and union nuts.

³ Standard scope of delivery: Fitting body only.

Male stud acc. to ANSI/ASME B1.20.1-1983

Port acc. to ANSI/ASME B1.20.1-1983

Suitable liquid / plastic sealant required.



Male Stud Barrel Tee
Type FI-LE-...-N • Series S

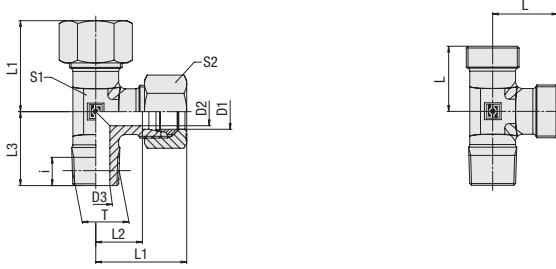

NPT Thread

Series	Tube OD PN		Dimensions											Weight (kg/lbs) ca. per 100 ²	Ordering Codes ³
	(mm/in)	(bar/psi)	Thread	T	D2	D3	i	L	L1 ¹	L2	L3	S1	S2		
S	6	630	1/4 NPT	4	4	10	23	31	16	26	12	17	5,57	FI-LE-06S1/4N-W3	
	.24	9135		0.16	0.16	0.39	0.91	1.22	0.63	1.02	0.47	0.67	12.26		
	8	630	1/4 NPT	5	5	10	24	32	17	27	14	19	7,54	FI-LE-08S1/4N-W3	
	.31	9135		0.20	0.20	0.39	0.94	1.26	0.67	1.06	0.55	0.75	16.58		
	10	630	3/8 NPT	7	7	10,5	25	34	17,5	28	17	22	10,50	FI-LE-10S3/8N-W3	
	.39	9135		0.28	0.28	0.41	0.98	1.34	0.69	1.10	0.67	0.87	23.10		
	12	630	3/8 NPT	8	8	10,5	29	38	21,5	28	17	24	12,07	FI-LE-12S3/8N-W3	
	.47	9135		0.31	0.31	0.41	1.14	1.50	0.85	1.10	0.67	0.94	26.55		
	14	630	1/2 NPT	10	10	14	30	40	22	34	19	27	15,11	FI-LE-14S1/2N-W3	
	.55	9135		0.39	0.39	0.55	1.18	1.57	0.87	1.34	0.75	1.06	33.25		
	16	630	1/2 NPT	12	12	14	33	43	24,5	36	24	30	20,16	FI-LE-16S1/2N-W3	
	.63	9135		0.47	0.47	0.55	1.30	1.69	0.96	1.42	0.94	1.18	44.35		
	20	400	3/4 NPT	16	16	14	37	48	26,5	42	27	36	35,00	FI-LE-20S3/4N-W3	
	.79	5800		0.63	0.63	0.55	1.46	1.89	1.04	1.65	1.06	1.42	77.00		
	25	400	1 NPT	20	20	17,5	42	54	30	48	36	46	56,00	FI-LE-25S1N-W3	
	.98	5800		0.79	0.79	0.69	1.65	2.13	1.18	1.89	1.42	1.81	123.20		
	30	400	1 1/4 NPT	25	32	18	49	62	35,5	54	41	50	74,20	FI-LE-30S1-1/4N-W3	
	1.18	5800		0.98	1.26	0.71	1.93	2.44	1.40	2.13	1.61	1.97	163.24		
	38	400	1 1/2 NPT	32	32	18	57	72	41	61	50	60	145,00	FI-LE-38S1-1/2N-W3	
	1.50	5800		1.26	1.26	0.71	2.24	2.83	1.61	2.40	1.97	2.36	319.00		

¹ Approximate dimension in assembled condition.
² Weight excluding cutting rings and union nuts.
³ Standard scope of delivery: Fitting body only.

Male stud acc. to ANSI/ASME B1.20.1-1983
 Port acc. to ANSI/ASME B1.20.1-1983
 Suitable liquid / plastic sealant required.

Ordering Codes

***FI-LE*-10*L*1/4N*-W3*-MS**

- * Male Stud Barrel Tee **FI-LE**
- * Outside Tube Diameter D1 (in mm) **-10**
- * Series Extra-Light Series (page 78) **LL**
 Light Series (page 78) **L**
 Heavy Series (page 79) **S**
- * Thread Size acc. to dimension table **1/4**

Please always indicate thread sizes, e.g. 1/4!

- * Thread Type NPT Thread **N**
- * Material Code Steel, zinc/nickel-plated **-W3**

Please contact STAUFF for alternative materials and surface finishings.





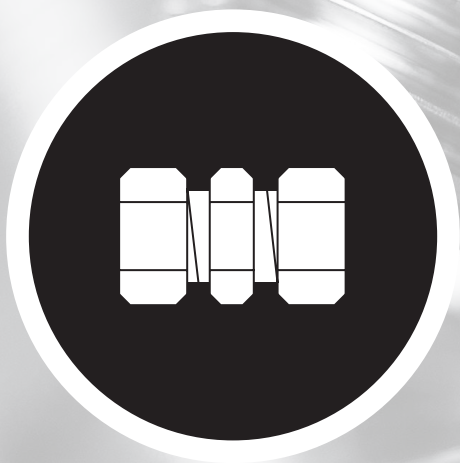

- * Assembling / Kitting Fitting body only **—**
- Fitting body supplied with cutting rings and union nuts **-MS**
- Fitting body supplied with soft-sealing cutting rings and union nuts **-MSV**

Connecting Parts

- Cutting Ring
Type **FI-DS** Page 26
- Soft-Sealing Cutting Ring
Type **FI-WDDS** Page 27
- Support Sleeve
Type **FI-VH** Page 28
- STAUFF Form Ring
Type **FI-AR** Page 30
- Union Nut
Type **FI-M** Page 31
- 37° Flared Tube Fitting Set
Type **FI-AB** Page 35





	Straight Union FI-G	82
	Straight Reducer FI-G	83
	Equal Elbow FI-W	85
	Equal Tee FI-T	86
	Tee Reducer FI-T	87
	Equal Cross FI-K	89

D



Straight Union Type FI-G ▪ Series LL / L / S

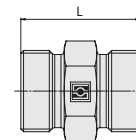
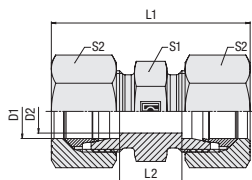

D

Ordering Codes

FI-G-10*L*-W3*-MS

- * Straight Union **FI-G**
- * Outside Tube Diameter D1 (in mm) **-10**
- * Series **LL**
 Extra-Light Series **L**
 Light Series **S**
 Heavy Series
- * Material Code **-W3**
 Steel, zinc/nickel-plated
- Please contact STAUFF for alternative materials and surface finishings.
- * Assembling / Kitting **—**
 Fitting body only
- Fitting body supplied with cutting rings and union nuts **-MS**
- Fitting body supplied with soft-sealing cutting rings and union nuts **-MSV**

Connecting Parts

- Cutting Ring
Type **FI-DS** Page 26
- Soft-Sealing Cutting Ring
Type **FI-WDDS** Page 27
- Support Sleeve
Type **FI-VH** Page 28
- STAUFF Form Ring
Type **FI-AR** Page 30
- Union Nut
Type **FI-M** Page 31
- 37° Flared Tube Fitting Set
Type **FI-AB** Page 35

Series	Tube OD	PN (bar/psi)	Dimensions (mm/in)						Weight (kg/lbs) ca. per 100 ²	Ordering Codes ³	
	D1		D2	L	L1 ¹	L2	S1	S2			
LL	4	100	3	20	31	12	9	10	0,53	FI-G-04LL-W3	
	.16	1450	.12	.79	1.22	.47	.35	.39	1.16		
	6	100	4,5	20	32	9	11	12	0,79	FI-G-06LL-W3	
	.24	1450	.18	.79	1.26	.35	.43	.47	1.74		
	8	100	6	23	35	12	12	14	1,05	FI-G-08LL-W3	
	.31	1450	.24	.91	1.38	.47	.47	.55	2.30		
	10	100	8	23	35	12	14	17	1,29	FI-G-10LL-W3	
	.39	1450	.31	.91	1.38	.47	.55	.67	2.83		
	12	100	10	23	35	11	17	19	1,83	FI-G-12LL-W3	
	.47	1450	.39	.91	1.38	.43	.67	.75	4.03		
	L	6	500	4	24	39	10	12	14	1,44	FI-G-06L-W3
		.24	7250	.16	.94	1.54	.39	.47	.55	3.17	
8		500	6	25	40	11	14	17	1,90	FI-G-08L-W3	
.31		7250	.24	.98	1.57	.43	.55	.67	4.18		
10		500	8	27	42	13	17	19	2,60	FI-G-10L-W3	
.39		7250	.31	1.06	1.65	.51	.67	.75	5.72		
12		400	10	28	43	14	19	22	2,67	FI-G-12L-W3	
.47		5800	.39	1.10	1.69	.55	.75	.87	5.87		
15		400	12	30	46	16	24	27	4,81	FI-G-15L-W3	
.59		5800	.47	1.18	1.81	.63	.94	1.06	10.57		
18		400	15	31	48	16	27	32	6,65	FI-G-18L-W3	
.71		5800	.59	1.22	1.89	.63	1.06	1.26	14.63		
22		250	19	35	52	20	32	36	8,94	FI-G-22L-W3	
.87		3625	.75	1.38	2.05	.79	1.26	1.42	19.66		
28		250	24	36	54	21	41	41	13,90	FI-G-28L-W3	
1.10		3625	.94	1.42	2.13	.83	1.61	1.61	30.57		
35		250	30	41	63	20	46	50	21,11	FI-G-35L-W3	
1.38		3625	1.18	1.61	2.48	.79	1.81	1.97	46.43		
42		250	36	43	66	21	55	60	29,26	FI-G-42L-W3	
1.65		3625	1.42	1.69	2.60	.83	2.17	2.36	64.38		
S		6	800	4	30	45	16	14	17	2,52	FI-G-06S-W3
		.24	11600	.16	1.18	1.77	.63	.55	.67	5.54	
		8	800	5	32	47	18	17	19	3,67	FI-G-08S-W3
		.31	11600	.20	1.26	1.85	.71	.67	.75	8.08	
	10	800	7	32	49	17	19	22	4,23	FI-G-10S-W3	
	.39	11600	.28	1.26	1.93	.67	.75	.87	9.30		
	12	630	8	34	51	19	22	24	5,88	FI-G-12S-W3	
	.47	9135	.31	1.34	2.01	.75	.87	.94	12.94		
	14	630	10	38	57	22	24	27	7,52	FI-G-14S-W3	
	.55	9135	.39	1.50	2.24	.87	.94	1.06	16.54		
	16	630	12	38	57	21	27	30	9,20	FI-G-16S-W3	
	.63	9135	.47	1.50	2.24	.83	1.06	1.18	20.25		
	20	400	16	44	66	23	32	36	14,27	FI-G-20S-W3	
	.79	5800	.63	1.73	2.60	.91	1.26	1.42	31.40		
	25	400	20	50	74	26	41	46	24,99	FI-G-25S-W3	
	.98	5800	.79	1.97	2.91	1.02	1.61	1.81	54.97		
	30	400	25	54	80	27	46	50	33,08	FI-G-30S-W3	
	1.18	5800	.98	2.13	3.15	1.06	1.81	1.97	72.77		
38	400	32	61	90	29	55	60	53,80	FI-G-38S-W3		
1.50	5800	1.26	2.40	3.54	1.14	2.17	2.36	118.36			

¹ Approximate dimension in assembled condition.

² Weight excluding cutting rings and union nuts.

³ Standard scope of delivery: Fitting body only.



Straight Reducer Type FI-G ▪ Series LL / L

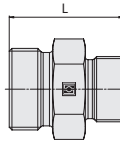
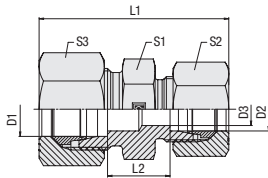

Series	Tube OD (mm/in)		PN (bar/psi)	Dimensions (mm/in)							Weight (kg/lbs) ca. per 100 ²	Ordering Codes ³
	D1	D2		D3	L	L1 ¹	L2	S1	S2	S3		
LL	6	4	100	3	20	32	10,5	11	10	12	0,70	FI-G-06/04LL-W3
	.24	.16	1450	.12	.79	1.26	.41	.43	.39	.47	1.54	
	8	4	100	3	22	34	12,5	12	10	14	1,00	FI-G-08/04LL-W3
	.31	.16	1450	.12	.87	1.34	.49	.47	.39	.55	2.20	
	8	6	100	4	22	34	11	12	12	14	0,99	FI-G-08/06LL-W3
	.31	.24	1450	.16	.87	1.34	.43	.47	.47	.55	2.18	
L	8	6	500	4	25	40	11	14	14	17	1,61	FI-G-08/06L-W3
	.31	.24	7250	.16	.98	1.57	.43	.55	.55	.67	3.54	
	10	6	500	4	26	41	12	17	14	19	1,99	FI-G-10/06L-W3
	.39	.24	7250	.16	1.02	1.61	.47	.67	.55	.75	4.37	
	10	8	500	6	26	41	12	17	17	19	2,21	FI-G-10/08L-W3
	.39	.31	7250	.24	1.02	1.61	.47	.67	.67	.75	4.86	
	12	6	400	4	27	42	13	19	14	22	2,47	FI-G-12/06L-W3
	.47	.24	5800	.16	1.06	1.65	.51	.75	.55	.87	5.43	
	12	8	400	6	27	42	13	19	17	22	2,63	FI-G-12/08L-W3
	.47	.31	5800	.24	1.06	1.65	.51	.75	.67	.87	5.78	
	12	10	400	8	28	43	14	19	19	22	2,81	FI-G-12/10L-W3
	.47	.39	5800	.31	1.10	1.69	.55	.75	.75	.87	6.19	
	15	10	400	8	29	45	15	24	19	27	4,36	FI-G-15/10L-W3
	.59	.39	5800	.31	1.14	1.77	.59	.94	.75	1.06	9.59	
	15	12	400	10	29	45	15	24	22	27	4,42	FI-G-15/12L-W3
	.59	.47	5800	.39	1.14	1.77	.59	.94	.87	1.06	9.73	
	18	10	400	8	30	46	15,5	27	19	32	6,01	FI-G-18/10L-W3
	.71	.39	5800	.31	1.18	1.81	.61	1.06	.75	1.26	13.22	
	18	12	400	10	30	46	15,5	27	22	32	5,56	FI-G-18/12L-W3
	.71	.47	5800	.39	1.18	1.81	.61	1.06	.87	1.26	12.22	
	18	15	400	12	31	48	16,5	27	27	32	6,73	FI-G-18/15L-W3
	.71	.59	5800	.47	1.22	1.89	.65	1.06	1.06	1.26	14.81	
	22	12	250	10	32	48	17,5	32	22	36	7,99	FI-G-22/12L-W3
	.87	.47	3625	.39	1.26	1.89	.69	1.26	.87	1.42	17.57	
	22	15	250	12	33	50	18,5	32	27	36	8,37	FI-G-22/15L-W3
	.87	.59	3625	.47	1.30	1.97	.73	1.26	1.06	1.42	18.41	
	22	18	250	15	33	50	18	32	32	36	8,76	FI-G-22/18L-W3
	.87	.71	3625	.59	1.30	1.97	.71	1.26	1.26	1.42	19.26	
	28	18	250	15	34	52	19	41	32	41	13,29	FI-G-28/18L-W3
	1.10	.71	3625	.59	1.34	2.05	.75	1.61	1.26	1.61	29.24	
28	22	250	19	36	54	21	41	36	41	13,61	FI-G-28/22L-W3	
1.10	.87	3625	.75	1.42	2.13	.83	1.61	1.42	1.61	29.94		
35	22	250	19	39	59	21	46	36	50	19,99	FI-G-35/22L-W3	
1.38	.87	3625	.75	1.54	2.32	.83	1.81	1.42	1.97	43.99		
35	28	250	24	39	59	21	46	41	50	19,71	FI-G-35/28L-W3	
1.38	1.10	3625	.94	1.54	2.32	.83	1.81	1.61	1.97	43.35		
42	35	250	30	42,5	66	21	55	50	60	29,78	FI-G-42/35L-W3	
1.65	1.38	3625	1.18	1.67	2.60	.83	2.17	1.97	2.36	65.52		

Ordering Codes

***FI-G*-10/*08*L*-W3*-MS**

- * Straight Reducer FI-G
 - * Outside Tube Diameter D1 (in mm) -10
 - * Outside Tube Diameter D2 (in mm) 08
 - * Series LL
L
S
 - * Material Code Steel, zinc/nickel-plated
-W3
- Please contact STAUFF for alternative materials and surface finishings.
- * Assembling / Kitting Fitting body only —
 - Fitting body supplied with cutting rings and union nuts -MS
 - Fitting body supplied with soft-sealing cutting rings and union nuts -MSV

Connecting Parts

-  Cutting Ring
Type **FI-DS** Page 26
-  Soft-Sealing Cutting Ring
Type **FI-WDDS** Page 27
-  Support Sleeve
Type **FI-VH** Page 28
-  STAUFF Form Ring
Type **FI-AR** Page 30
-  Union Nut
Type **FI-M** Page 31
-  37° Flared Tube Fitting Set
Type **FI-AB** Page 35

¹ Approximate dimension in assembled condition.
² Weight excluding cutting rings and union nuts.
³ Standard scope of delivery: Fitting body only.



Straight Reducer Type FI-G ▪ Series S

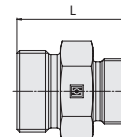
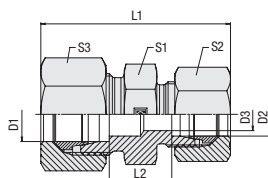

D

Ordering Codes

FI-G-10/*08*L*-W3*-MS

- * Straight Reducer **FI-G**
- * Outside Tube Diameter D1 (in mm) **-10**
- * Outside Tube Diameter D2 (in mm) **08**
- * Series **LL**
 Extra-Light Series (page 83)
L
 Light Series (page 83)
S
 Heavy Series (page 84)
- * Material Code **-W3**
 Steel, zinc/nickel-plated
- Please contact STAUFF for alternative materials and surface finishings.
- * Assembling / Kitting **—**
 Fitting body only
- Fitting body supplied with cutting rings and union nuts **-MS**
- Fitting body supplied with soft-sealing cutting rings and union nuts **-MSV**

Connecting Parts

- Cutting Ring
Type **FI-DS** Page 26
- Soft-Sealing Cutting Ring
Type **FI-WDDS** Page 27
- Support Sleeve
Type **FI-VH** Page 28
- STAUFF Form Ring
Type **FI-AR** Page 30
- Union Nut
Type **FI-M** Page 31
- 37° Flared Tube Fitting Set
Type **FI-AB** Page 35

Series	Tube OD (mm/in)		PN (bar/psi)	Dimensions (mm/in)						Weight (kg/lbs) ca. per 100 ²	Ordering Codes ³	
	D1	D2		D3	L	L1 ¹	L2	S1	S2			S3
S	8	6	800	4	32	47	18	17	17	19	3,46	FI-G-08/06S-W3
	.31	.24	11600	.16	1.26	1.85	.71	.67	.67	.75	7.60	
	10	6	800	4	32	48	17,5	19	17	22	4,40	FI-G-10/06S-W3
	.39	.24	11600	.16	1.26	1.89	.69	.75	.67	.87	9.68	
	10	8	800	5	32	48	17,5	19	19	22	4,26	FI-G-10/08S-W3
	.39	.31	11600	.20	1.26	1.89	.69	.75	.75	.87	9.37	
	12	6	630	4	34	50	19,5	22	17	24	5,56	FI-G-12/06S-W3
	.47	.24	9135	.16	1.34	1.97	.77	.87	.67	.94	12.24	
	12	8	630	5	34	50	19,5	22	19	24	4,03	FI-G-12/08S-W3
	.47	.31	9135	.20	1.34	1.97	.77	.87	.75	.94	8.87	
	12	10	630	7	34	51	19	22	22	24	5,86	FI-G-12/10S-W3
	.47	.39	9135	.28	1.34	2.01	.75	.87	.87	.94	12.90	
	14	10	630	7	36	54	20,5	24	22	27	7,16	FI-G-14/10S-W3
	.55	.39	9135	.28	1.42	2.13	.81	.94	.87	1.06	15.76	
	14	12	630	8	36	54	20,5	24	24	27	7,34	FI-G-14/12S-W3
	.55	.47	9135	.31	1.42	2.13	.81	.94	.94	1.06	16.15	
	16	10	630	7	36	54	20	27	22	30	7,95	FI-G-16/10S-W3
	.63	.39	9135	.28	1.42	2.13	.79	1.06	.87	1.18	17.49	
	16	12	630	8	36	54	20	27	24	30	9,32	FI-G-16/12S-W3
	.63	.47	9135	.31	1.42	2.13	.79	1.06	.94	1.18	20.50	
	16	14	630	10	38	57	21,5	27	27	30	8,95	FI-G-16/14S-W3
	.63	.55	9135	.39	1.50	2.24	.85	1.06	1.06	1.18	19.69	
	20	10	400	7	40	60	22	32	22	36	12,93	FI-G-20/10S-W3
	.79	.39	5800	.28	1.57	2.36	.87	1.26	.87	1.42	28.44	
	20	12	400	8	40	60	22	32	24	36	13,19	FI-G-20/12S-W3
	.79	.47	5800	.31	1.57	2.36	.87	1.26	.94	1.42	29.02	
	20	16	400	12	42	63	23	32	30	36	13,38	FI-G-20/16S-W3
	.79	.63	5800	.47	1.65	2.48	.91	1.26	1.18	1.42	29.44	
25	16	400	12	46	68	25,5	41	30	46	22,87	FI-G-25/16S-W3	
.98	.63	5800	.47	1.81	2.68	1.00	1.61	1.18	1.81	50.31		
25	20	400	16	48	71	25,5	41	36	46	23,66	FI-G-25/20S-W3	
.98	.79	5800	.63	1.89	2.80	1.00	1.61	1.42	1.81	52.05		
30	20	400	16	50	74	26	46	36	50	30,33	FI-G-30/20S-W3	
1.18	.79	5800	.63	1.97	2.91	1.02	1.81	1.42	1.97	66.73		
30	25	400	20	52	77	26,5	46	46	50	31,79	FI-G-30/25S-W3	
1.18	.98	5800	.79	2.05	3.03	1.04	1.81	1.81	1.97	69.95		
38	30	400	25	59	87	29,5	55	50	60	50,90	FI-G-38/30S-W3	
1.50	1.18	5800	.98	2.32	3.43	1.16	2.17	1.97	2.36	111.98		

¹ Approximate dimension in assembled condition.

² Weight excluding cutting rings and union nuts.

³ Standard scope of delivery: Fitting body only.

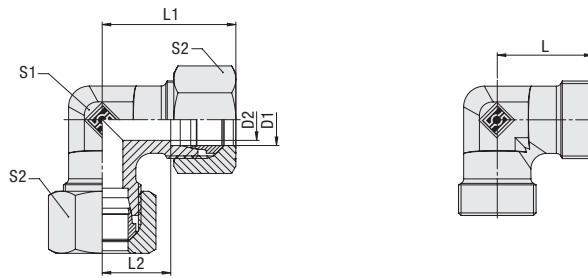

Equal Elbow
Type FI-W ▪ Series LL / L / S

Series	Tube OD		PN (bar/PSI)	Dimensions (mm/in)						Weight (%/lbs) ca. per 100 ²	Ordering Codes ³
	D1	D2		L	L1 ¹	L2	S1	S2			
LL	4	100	3	15	21	11	9	10	1,29	FI-W-04LL-W3-PR	
	.16	1450	.12	.59	.83	.43	.35	.39	2.83		
	6	100	4,5	15	21	9,5	11	12	1,57	FI-W-06LL-W3-PR	
	.24	1450	.18	.59	.83	.37	.43	.47	3.45		
	8	100	6	17	23	11,5	12	14	2,22	FI-W-08LL-W3-PR	
.31	1450	.24	.67	.91	.45	.47	.55	4.88			
L	6	500	4	19	27	12	12	14	1,94	FI-W-06L-W3	
	.24	7250	.16	.75	1.06	.47	.47	.55	4.27		
	8	500	6	21	29	14	12	17	2,35	FI-W-08L-W3	
	.31	7250	.24	.83	1.14	.55	.47	.67	5.17		
	10	500	8	22	30	15	14	19	3,06	FI-W-10L-W3	
	.39	7250	.31	.87	1.18	.59	.55	.75	6.72		
	12	400	10	24	32	17	17	22	4,34	FI-W-12L-W3	
	.47	5800	.39	.94	1.26	.67	.67	.87	9.55		
	15	400	12	28	36	21	19	27	5,13	FI-W-15L-W3	
	.59	5800	.47	1.10	1.42	.83	.75	1.06	11.29		
	18	400	15	31	40	23,5	24	32	11,63	FI-W-18L-W3	
	.71	5800	.59	1.22	1.57	.93	.94	1.26	25.59		
	22	250	19	35	44	27,5	27	36	15,35	FI-W-22L-W3	
	.87	3625	.75	1.38	1.73	1.08	1.06	1.42	33.77		
	28	250	24	38	47	30,5	36	41	25,45	FI-W-28L-W3	
	1.10	3625	.94	1.50	1.85	1.20	1.42	1.61	56.00		
	35	250	30	45	56	34,5	41	50	42,04	FI-W-35L-W3	
	1.38	3625	1.18	1.77	2.20	1.36	1.61	1.97	92.48		
	42	250	36	51	63	40	50	60	63,20	FI-W-42L-W3	
	1.65	3625	1.42	2.01	2.48	1.57	1.97	2.36	139.04		
S	6	800	4	23	31	16	12	17	3,32	FI-W-06S-W3	
	.24	11600	.16	.91	1.22	.63	.47	.67	7.30		
	8	800	5	24	32	17	14	19	4,68	FI-W-08S-W3	
	.31	11600	.20	.94	1.26	.67	.55	.75	10.30		
	10	800	7	25	34	17,5	17	22	6,02	FI-W-10S-W3	
	.39	11600	.28	.98	1.34	.69	.67	.87	13.24		
	12	630	8	29	38	21,5	17	24	8,14	FI-W-12S-W3	
	.47	9135	.31	1.14	1.50	.85	.67	.94	17.91		
	14	630	10	30	40	22	19	27	9,86	FI-W-14S-W3	
	.55	9135	.39	1.18	1.57	.87	.75	1.06	21.69		
	16	630	12	33	43	24,5	24	30	14,13	FI-W-16S-W3	
	.63	9135	.47	1.30	1.69	.96	.94	1.18	31.09		
	20	400	16	37	48	26,5	27	36	20,50	FI-W-20S-W3	
	.79	5800	.63	1.46	1.89	1.04	1.06	1.42	45.10		
	25	400	20	42	54	30	36	46	36,09	FI-W-25S-W3	
.98	5800	.79	1.65	2.13	1.18	1.42	1.81	79.40			
30	400	25	49	62	35,5	41	50	40,20	FI-W-30S-W3		
1.18	5800	.98	1.93	2.44	1.40	1.61	1.97	102.11			
38	400	32	57	72	41	50	60	89,05	FI-W-38S-W3		
1.50	5800	1.26	2.24	2.83	1.61	1.97	2.36	196.90			

Ordering Codes
***FI-W*-10*L*-W3*-MS**

* Equal Elbow		FI-W
* Outside Tube Diameter D1 (in mm)		-10
* Series	Extra-Light Series	LL
	Light Series	L
	Heavy Series	S
* Material Code	Steel, zinc/nickel-plated	-W3
Please contact STAUFF for alternative materials and surface finishings.		
* Design	Made from forging blanks	—
	Made from profile material	PR
* Assembling / Kitting	Fitting body only	—
	Fitting body supplied with cutting rings and union nuts	-MS
	Fitting body supplied with soft-sealing cutting rings and union nuts	-MSV

Connecting Parts

	Cutting Ring Type FI-DS	Page 26
	Soft-Sealing Cutting Ring Type FI-WDDS	Page 27
	Support Sleeve Type FI-VH	Page 28
	STAUFF Form Ring Type FI-AR	Page 30
	Union Nut Type FI-M	Page 31
	37° Flared Tube Fitting Set Type FI-AB	Page 35

¹ Approximate dimension in assembled condition.

² Weight excluding cutting rings and union nuts.

³ Standard scope of delivery: Fitting body only.

Equal Tee Type FI-T • Series LL / L / S

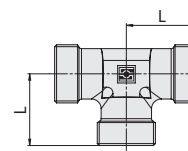
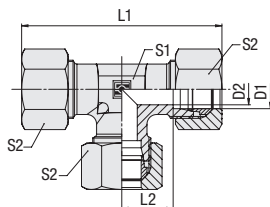

D

Ordering Codes

FI-T-10*L*-W3*-MS

- * Equal Tee FI-T
- * Outside Tube Diameter D1 (in mm) -10
- * Series LL
 Extra-Light Series L
 Light Series S
 Heavy Series
- * Material Code -W3
 Steel, zinc/nickel-plated
- Please contact STAUFF for alternative materials and surface finishings.
- * Assembling / Kitting —
 Fitting body only
- Fitting body supplied with cutting rings and union nuts -MS
- Fitting body supplied with soft-sealing cutting rings and union nuts -MSV

Connecting Parts

- Cutting Ring
Type FI-DS Page 26
- Soft-Sealing Cutting Ring
Type FI-WDDS Page 27
- Support Sleeve
Type FI-VH Page 28
- STAUFF Form Ring
Type FI-AR Page 30
- Union Nut
Type FI-M Page 31
- 37° Flared Tube Fitting Set
Type FI-AB Page 35

Series	Tube OD	PN	Dimensions						Weight (^{kg} /lbs) ca. per 100 ²	Ordering Codes ³
	(mm/in) D1		(bar/PSI)	(mm/in) D2	L	L1 ¹	L2	S1		
LL	4	100	3	15	42	11	9	10	1,00	FI-T-04LL-W3
	.16	1450	.12	.59	1.65	.43	.35	.39	2.20	
	6	100	4,5	15	42	9,5	9	12	1,23	FI-T-06LL-W3
	.24	1450	.18	.59	1.65	.37	.35	.47	2.70	
	8	100	6	17	46	11,5	12	14	1,91	FI-T-08LL-W3
.31	1450	.24	.67	1.81	.45	.47	.55	4.19		
L	6	500	4	19	54	12	12	14	2,66	FI-T-06L-W3
	.24	7250	.16	.75	2.13	.47	.47	.55	5.86	
	8	500	6	21	58	14	12	17	3,17	FI-T-08L-W3
	.31	7250	.24	.83	2.28	.55	.47	.67	6.97	
	10	500	8	22	60	15	14	19	4,06	FI-T-10L-W3
	.39	7250	.31	.87	2.36	.59	.55	.75	8.93	
	12	400	10	24	64	17	17	22	5,52	FI-T-12L-W3
	.47	5800	.39	.94	2.52	.67	.67	.87	12.15	
	15	400	12	28	72	21	19	27	9,98	FI-T-15L-W3
	.59	5800	.47	1.10	2.83	.83	.75	1.06	21.95	
	18	400	15	31	80	23,5	24	32	14,83	FI-T-18L-W3
	.71	5800	.59	1.22	3.15	.93	.94	1.26	32.63	
	22	250	19	35	88	27,5	27	36	18,81	FI-T-22L-W3
	.87	3625	.75	1.38	3.46	1.08	1.06	1.42	41.39	
	28	250	24	38	94	30,5	36	41	30,44	FI-T-28L-W3
	1.10	3625	.94	1.50	3.70	1.20	1.42	1.61	66.97	
	35	250	30	45	112	34,5	41	50	49,27	FI-T-35L-W3
	1.38	3625	1.18	1.77	4.41	1.36	1.61	1.97	108.39	
	42	250	36	51	126	40	50	60	72,20	FI-T-42L-W3
	1.65	3625	1.42	2.01	4.96	1.57	1.97	2.36	158.84	
S	6	800	4	23	62	16	12	17	4,60	FI-T-06S-W3
	.24	11600	.16	.91	2.44	.63	.47	.67	10.12	
	8	800	5	24	64	17	14	19	6,21	FI-T-08S-W3
	.31	11600	.20	.94	2.52	.67	.55	.75	13.65	
	10	800	7	25	68	17,5	17	22	7,92	FI-T-10S-W3
	.39	11600	.28	.98	2.68	.69	.67	.87	17.42	
	12	630	8	29	76	21,5	17	24	10,88	FI-T-12S-W3
	.47	9135	.31	1.14	2.99	.85	.67	.94	23.93	
	14	630	10	30	80	22	19	27	12,97	FI-T-14S-W3
	.55	9135	.39	1.18	3.15	.87	.75	1.06	28.53	
	16	630	12	33	86	24,5	24	30	10,97	FI-T-16S-W3
	.63	9135	.47	1.30	3.39	.96	.94	1.18	24.14	
	20	400	16	37	96	26,5	27	36	25,58	FI-T-20S-W3
	.79	5800	.63	1.46	3.78	1.04	1.06	1.42	56.28	
	25	400	20	42	108	30	36	46	44,75	FI-T-25S-W3
	.98	5800	.79	1.65	4.25	1.18	1.42	1.81	98.46	
	30	400	25	49	124	35,5	41	50	68,20	FI-T-30S-W3
	1.18	5800	.98	1.93	4.88	1.40	1.61	1.97	150.04	
38	400	32	57	144	41	50	60	108,00	FI-T-38S-W3	
1.50	5800	1.26	2.24	5.67	1.61	1.97	2.36	237.60		

¹ Approximate dimension in assembled condition.

² Weight excluding cutting rings and union nuts.

³ Standard scope of delivery: Fitting body only.



Tee Reducer
Type FI-T • Series L

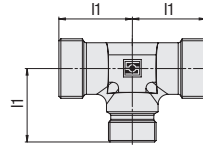
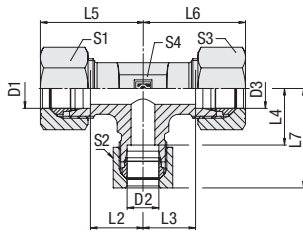

Sequence of connections
in the ordering codes for
tee reducers:



Series	Tube OD (mm/in)			PN (bar/psi)	Dimensions (mm/in)													Weight (kg/lbs) ca. per 100 ²	Ordering Codes ³
	D1	D2	D3		I1	L1	L2	L3	L4	L5 ¹	L6 ¹	L7 ¹	S1	S2	S3				
L	6	8	6	500	21	14	14	14	29	29	29	14	17	14	12	3,81	FI-T-06/08/06L-W3		
	.24	.31	.24	7250	.83	.55	.55	.55	1.14	1.14	1.14	.55	.67	.55	.47	8.38			
	6	10	6	500	22	15	15	15	30	30	30	14	19	14	14	4,90	FI-T-06/10/06L-W3		
	.24	.39	.24	7250	.87	.59	.59	.59	1.18	1.18	1.18	.55	.75	.55	.55	10.78			
	8	6	8	500	21	14	14	14	29	29	29	17	14	17	12	3,27	FI-T-08/06/08L-W3		
	.31	.24	.31	7250	.83	.55	.55	.55	1.14	1.14	1.14	.67	.55	.67	.47	7.20			
	8	10	8	500	22	15	15	15	30	30	30	17	19	17	14	4,35	FI-T-08/10/08L-W3		
	.31	.39	.31	7250	.87	.59	.59	.59	1.18	1.18	1.18	.67	.75	.67	.55	9.57			
	8	12	8	400	24	17	17	17	32	32	32	17	22	17	17	5,94	FI-T-08/12/08L-W3		
	.31	.47	.31	5800	.94	.67	.67	.67	1.26	1.26	1.26	.67	.87	.67	.67	13.06			
	10	6	10	500	22	15	15	15	30	30	30	19	14	19	14	4,18	FI-T-10/06/10L-W3		
	.39	.24	.39	7250	.87	.59	.59	.59	1.18	1.18	1.18	.75	.55	.75	.55	9.19			
	10	8	10	500	22	15	15	15	30	30	30	19	17	19	14	4,11	FI-T-10/08/10L-W3		
	.39	.31	.39	7250	.87	.59	.59	.59	1.18	1.18	1.18	.75	.67	.75	.55	9.05			
	10	15	10	400	28	21	21	21	36	36	36	19	27	19	19	10,05	FI-T-10/15/10L-W3		
	.39	.59	.39	5800	1.10	.83	.83	.83	1.42	1.42	1.42	.75	1.06	.75	.75	22.10			
	12	6	12	400	24	17	17	17	32	32	32	22	14	22	17	5,66	FI-T-12/06/12L-W3		
	.47	.24	.47	5800	.94	.67	.67	.67	1.26	1.26	1.26	.87	.55	.87	.67	12.44			
	12	8	12	400	24	17	17	17	32	32	32	22	17	22	17	5,68	FI-T-12/08/12L-W3		
	.47	.31	.47	5800	.94	.67	.67	.67	1.26	1.26	1.26	.87	.67	.87	.67	12.50			
	12	10	12	400	24	17	17	17	32	32	32	22	19	22	17	5,58	FI-T-12/10/12L-W3		
	.47	.39	.47	5800	.94	.67	.67	.67	1.26	1.26	1.26	.87	.75	.87	.67	12.28			
	12	15	12	400	28	21	21	21	36	36	36	22	27	22	19	9,73	FI-T-12/15/12L-W3		
	.47	.59	.47	5800	1.10	.83	.83	.83	1.42	1.42	1.42	.87	1.06	.87	.75	21.41			
	12	18	12	400	31	24	23,5	24	39	40	39	22	32	22	24	14,87	FI-T-12/18/12L-W3		
	.47	.71	.47	5800	1.22	.94	.93	.94	1.54	1.57	1.54	.87	1.26	.87	.94	32.72			
	15	6	15	400	28	21	21	21	36	36	36	27	14	27	19	10,06	FI-T-15/06/15L-W3		
	.59	.24	.59	5800	1.10	.83	.83	.83	1.42	1.42	1.42	1.06	.55	1.06	.75	22.14			
	15	10	15	400	28	21	21	21	36	36	36	27	19	27	19	9,82	FI-T-15/10/15L-W3		
	.59	.39	.59	5800	1.10	.83	.83	.83	1.42	1.42	1.42	1.06	.75	1.06	.75	21.61			
	15	12	15	400	28	21	21	21	36	36	36	27	22	27	19	9,70	FI-T-15/12/15L-W3		
	.59	.47	.59	5800	1.10	.83	.83	.83	1.42	1.42	1.42	1.06	.87	1.06	.75	21.35			
	15	18	15	400	31	24	23,5	24	39	40	39	27	32	27	24	15,22	FI-T-15/18/15L-W3		
	.59	.71	.59	5800	1.22	.94	.93	.94	1.54	1.57	1.54	1.06	1.26	1.06	.94	33.48			
	18	10	18	400	31	23,5	24	23,5	40	39	40	32	19	32	24	14,52	FI-T-18/10/18L-W3		
	.71	.39	.71	5800	1.22	.93	.94	.93	1.57	1.54	1.57	1.26	.75	1.26	.94	31.95			
	18	12	18	400	31	23,5	24	23,5	40	39	40	32	22	32	24	14,76	FI-T-18/12/18L-W3		
	.71	.47	.71	5800	1.22	.93	.94	.93	1.57	1.54	1.57	1.26	.87	1.26	.94	32.48			
	18	15	18	400	31	23,5	24	23,5	40	39	40	32	27	32	24	14,62	FI-T-18/15/18L-W3		
	.71	.59	.71	5800	1.22	.93	.94	.93	1.57	1.54	1.57	1.26	1.06	1.26	.94	32.16			

¹ Approximate dimension in assembled condition.

² Weight excluding cutting rings and union nuts.

³ Standard scope of delivery: Fitting body only.

Ordering Codes

***FI-T*-10/*08/*10*L*-W3*-MS**

- * Tee Reducer FI-T
- * Outside Tube Diameter D1 (in mm) -10
- * Outside Tube Diameter D2 (in mm) 08
- * Outside Tube Diameter D3 (in mm) 10
- * Series L
Light Series (page 87)
Heavy Series (page 88) S
- * Material Code -W3
Steel, zinc/nickel-plated
- Please contact STAUFF for alternative materials and surface finishings.
- * Assembling / Kitting —
Fitting body only
- Fitting body supplied with cutting rings and union nuts -MS
- Fitting body supplied with soft-sealing cutting rings and union nuts -MSV

Connecting Parts

-  Cutting Ring
Type **FI-DS** Page 26
-  Soft-Sealing Cutting Ring
Type **FI-WDDS** Page 27
-  Support Sleeve
Type **FI-VH** Page 28
-  STAUFF Form Ring
Type **FI-AR** Page 30
-  Union Nut
Type **FI-M** Page 31
-  37° Flared Tube Fitting Set
Type **FI-AB** Page 35



Equal Cross
Type FI-K • Series LL / L / S

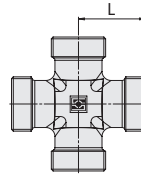
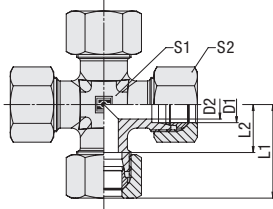

Series	Tube OD		Dimensions							Weight (%/lbs) ca. per 100 ²	Ordering Codes ³
	(mm/in)	PN (bar/PSI)	(mm/in)								
	D1		D2	L	L1 ¹	L2	S1	S2			
LL	4	100	3	15	21	11	9	10	1,68	FI-K-04LL-W3	
	.16	1450	.12	.59	.83	.43	.35	.39	3.69		
	6	100	4,5	15	21	9,5	9	12	1,76	FI-K-06LL-W3	
	.24	1450	.18	.59	.83	.37	.35	.47	3.87		
	8	100	6	17	23	11,5	12	14	2,85	FI-K-08LL-W3	
.31	1450	.24	.67	.91	.45	.47	.55	6.27			
L	6	500	4	19	27	12	12	14	3,40	FI-K-06L-W3	
	.24	7250	.16	.75	1.06	.47	.47	.55	7.48		
	8	500	6	21	29	14	12	17	3,93	FI-K-08L-W3	
	.31	7250	.24	.83	1.14	.55	.47	.67	8.64		
	10	500	8	22	30	15	14	19	5,01	FI-K-10L-W3	
	.39	7250	.31	.87	1.18	.59	.55	.75	11.02		
	12	400	10	24	32	17	17	22	6,90	FI-K-12L-W3	
	.47	5800	.39	.94	1.26	.67	.67	.87	15.19		
	15	400	12	28	36	21	19	27	12,36	FI-K-15L-W3	
	.59	5800	.47	1.10	1.42	.83	.75	1.06	27.19		
	18	400	15	31	40	23,5	24	32	17,40	FI-K-18L-W3	
	.71	5800	.59	1.22	1.57	.93	.94	1.26	38.28		
	22	250	19	35	44	27,5	27	36	22,60	FI-K-22L-W3	
	.87	3625	.75	1.38	1.73	1.08	1.06	1.42	49.72		
	28	250	24	38	47	30,5	36	41	35,60	FI-K-28L-W3	
	1.10	3625	.94	1.50	1.85	1.20	1.42	1.61	78.32		
	35	250	30	45	56	34,5	41	50	54,67	FI-K-35L-W3	
	1.38	3625	1.18	1.77	2.20	1.36	1.61	1.97	120.27		
	42	250	36	51	63	40	50	60	92,70	FI-K-42L-W3	
	1.65	3625	1.42	2.01	2.48	1.57	1.97	2.36	209.30		
	S	6	800	4	23	31	16	12	17	5,79	FI-K-06S-W3
		.24	11600	.16	.91	1.22	.63	.47	.67	12.74	
8		800	5	24	32	17	14	19	7,91	FI-K-08S-W3	
.31		11600	.20	.94	1.26	.67	.55	.75	17.41		
10		800	7	25	34	17,5	17	22	10,13	FI-K-10S-W3	
.39		11600	.28	.98	1.34	.69	.67	.87	22.28		
12		630	8	29	38	21,5	17	24	13,59	FI-K-12S-W3	
.47		9135	.31	1.14	1.50	.85	.67	.94	29.90		
14		630	10	30	40	22	19	27	16,21	FI-K-14S-W3	
.55		9135	.39	1.18	1.57	.87	.75	1.06	35.65		
16		630	12	33	43	24,5	24	30	22,15	FI-K-16S-W3	
.63		9135	.47	1.30	1.69	.96	.94	1.18	48.73		
20		400	16	37	48	26,5	27	36	31,07	FI-K-20S-W3	
.79		5800	.63	1.46	1.89	1.04	1.06	1.42	68.35		
25		400	20	42	54	30	36	46	53,00	FI-K-25S-W3	
.98	5800	.79	1.65	2.13	1.18	1.42	1.81	116.60			
30	400	25	49	62	35,5	41	50	84,30	FI-K-30S-W3		
1.18	5800	.98	1.93	2.44	1.40	1.61	1.97	185.46			
38	400	32	57	72	41	50	60	135,10	FI-K-38S-W3		
1.50	5800	1.26	2.24	2.83	1.61	1.97	2.36	297.22			

Ordering Codes

FI-K-10*L*-W3*-MS

- * Equal Cross FI-K
- * Outside Tube Diameter D1 (in mm) -10
- * Series LL
Extra-Light Series
LLight Series
SHeavy Series
- * Material Code -W3
Steel, zinc/nickel-plated
- Please contact STAUFF for alternative materials and surface finishings.
- * Assembling / Kitting —
Fitting body only
- Fitting body supplied with cutting rings and union nuts -MS
- Fitting body supplied with soft-sealing cutting rings and union nuts -MSV

Connecting Parts

-  Cutting Ring
Type FI-DS Page 26
-  Soft-Sealing Cutting Ring
Type FI-WDDS Page 27
-  Support Sleeve
Type FI-VH Page 28
-  STAUFF Form Ring
Type FI-AR Page 30
-  Union Nut
Type FI-M Page 31
-  37° Flared Tube Fitting Set
Type FI-AB Page 35

¹ Approximate dimension in assembled condition.
² Weight excluding cutting rings and union nuts.
³ Standard scope of delivery: Fitting body only.





**Straight Bulkhead Fitting**

FI-GS

92

**Elbow Bulkhead Fittings**

FI-WS

93

**Straight Bulkhead Weld Fitting**

FI-ES

94



**Straight Bulkhead Fitting
Type FI-GS ▪ Series L / S**

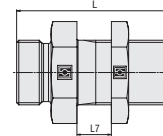
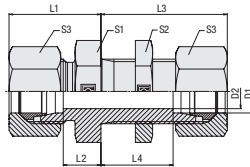

Ordering Codes

***FI-GS*-10*L*-W3*-MS**

- * Straight Bulkhead Fitting **FI-GS**
 - * Outside Tube Diameter D1 (in mm) **-10**
 - * Series **L**
Light Series **L**
Heavy Series **S**
 - * Material Code **-W3**
Steel, zinc/nickel-plated
 - * Assembling / Kitting **—**
Fitting body only
Fitting body supplied with hexagon lock nut **-SKM**
Fitting body supplied with cutting rings and union nuts **-MS**
Fitting body supplied with soft-sealing cutting rings and union nuts **-MSV**
- Please contact STAUFF for alternative materials and surface finishings.

Connecting Parts

- Cutting Ring
Type **FI-DS** Page 26
- Soft-Sealing Cutting Ring
Type **FI-WDDS** Page 27
- Support Sleeve
Type **FI-VH** Page 28
- STAUFF Form Ring
Type **FI-AR** Page 30
- Union Nut
Type **FI-M** Page 31
- 37° Flared Tube Fitting Set
Type **FI-AB** Page 35

Spare Parts / Accessories

- Hexagon Lock Nut
Type **FI-SKM** Page 205

Series	Tube OD (mm/in)	PN (bar/psi)	Dimensions (mm/in)											Weight (kg/lbs) ca. per 100 ²	Ordering Codes ³
	D1		D2	L	L1 ¹	L2	L3 ¹	L4	L7 min	L7 max	S1	S2	S3		
L	6	500	4	48	22	7	42	27	3	16	17	17	14	3,85	FI-GS-06L-W3-SKM
	.24	7250	.16	1.89	.87	.28	1.65	1.06	.12	.63	.67	.67	.55	8,48	
	8	500	6	49	23	8	42	27	3	16	19	19	17	4,93	FI-GS-08L-W3-SKM
	.31	7250	.24	1.93	.91	.31	1.65	1.06	.12	.63	.75	.75	.67	10,85	
	10	500	8	52	25	10	43	28	3	16	22	22	19	6,76	FI-GS-10L-W3-SKM
	.39	7250	.31	2.05	.98	.39	1.69	1.10	.12	.63	.87	.87	.75	14,87	
	12	400	10	53	25	10	44	29	3	16	24	24	22	7,81	FI-GS-12L-W3-SKM
	.47	5800	.39	2.09	.98	.39	1.73	1.14	.12	.63	.94	.94	.87	17,18	
	15	400	12	57	27	12	46	31	3	16	27	30	27	12,89	FI-GS-15L-W3-SKM
	.59	5800	.47	2.24	1.06	.47	1.81	1.22	.12	.63	1.06	1.18	1.06	28,37	
	18	400	15	61	30	13,5	49	32,5	3	16	32	36	32	19,87	FI-GS-18L-W3-SKM
	.71	5800	.59	2.40	1.18	.53	1.93	1.28	.12	.63	1.26	1.42	1.26	43,72	
	22	250	19	66	33	16,5	51	34,5	4	16	36	41	36	25,19	FI-GS-22L-W3-SKM
	.87	3625	.75	2.60	1.30	.65	2.01	1.36	.16	.63	1.42	1.61	1.42	55,42	
	28	250	24	69	35	18,5	52	35,5	4	16	41	46	41	34,12	FI-GS-28L-W3-SKM
	1.10	3625	.94	2.72	1.38	.73	2.05	1.40	.16	.63	1.61	1.81	1.61	75,07	
	35	250	30	76	40	18,5	58	36,5	4	16	50	55	50	55,40	FI-GS-35L-W3-SKM
	1.38	3625	1.18	2.99	1.57	.73	2.28	1.44	.16	.63	1.97	2.17	1.97	121,88	
	42	250	36	77	42	19	59	36	4	16	60	65	60	75,30	FI-GS-42L-W3-SKM
	1.65	3625	1.42	3.03	1.65	.75	2.32	1.42	.16	.63	2.36	2.56	2.36	165,66	
S	6	800	4	55	27	12	44	29	3	16	19	19	17	6,50	FI-GS-06S-W3-SKM
	.24	11600	.16	2.17	1.06	.47	1.73	1.14	.12	.63	.75	.75	.67	14,30	
	8	800	5	56	28	13	44	29	3	16	22	22	19	8,84	FI-GS-08S-W3-SKM
	.31	11600	.20	2.20	1.10	.51	1.73	1.14	.12	.63	.87	.87	.75	19,44	
	10	800	7	59	31	14,5	46	29,5	3	16	24	24	22	11,18	FI-GS-10S-W3-SKM
	.39	11600	.28	2.32	1.22	.57	1.81	1.16	.12	.63	.94	.94	.87	24,59	
	12	630	8	60	31	14,5	47	30,5	3	16	27	27	24	14,00	FI-GS-12S-W3-SKM
	.47	9135	.31	2.36	1.22	.57	1.85	1.20	.12	.63	1.06	1.06	.94	30,80	
	14	630	10	65	35	17	50	32	3	16	30	30	27	18,17	FI-GS-14S-W3-SKM
	.55	9135	.39	2.56	1.38	.67	1.97	1.26	.12	.63	1.18	1.18	1.06	39,97	
	16	630	12	65	35	16,5	50	31,5	3	16	32	32	30	20,12	FI-GS-16S-W3-SKM
	.63	9135	.47	2.56	1.38	.65	1.97	1.24	.12	.63	1.26	1.26	1.18	44,27	
	20	400	16	72	39	17,5	55	33,5	4	16	41	41	36	34,45	FI-GS-20S-W3-SKM
	.79	5800	.63	2.83	1.54	.69	2.17	1.32	.16	.63	1.61	1.61	1.42	75,79	
	25	400	20	79	44	20	59	35	4	16	46	46	46	49,56	FI-GS-25S-W3-SKM
.98	5800	.79	3.11	1.73	.79	2.32	1.38	.16	.63	1.81	1.81	1.81	109,04		
30	400	25	86	48	21,5	64	37,5	4	16	50	50	50	64,90	FI-GS-30S-W3-SKM	
1.18	5800	.98	3.39	1.89	.85	2.52	1.48	.16	.63	1.97	1.97	1.97	142,78		
38	400	32	91	53	22	68	37	4	16	65	65	60	108,30	FI-GS-38S-W3-SKM	
1.50	5800	1.26	3.58	2.09	.87	2.68	1.46	.16	.63	2.56	2.56	2.36	238,26		

¹ Approximate dimension in assembled condition.
² Weight excluding lock nut, cutting rings and union nuts.
³ Standard scope of delivery: Fitting body with hexagon lock nut.



Elbow Bulkhead Fittings
Type FI-WS • Series L / S

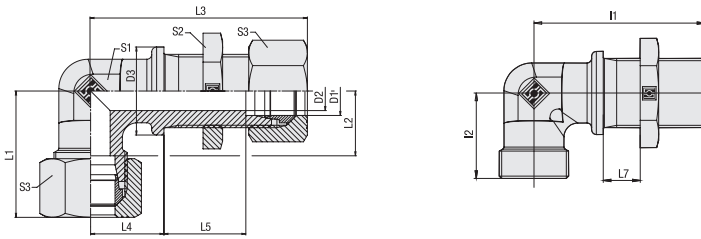

Series	Tube OD (mm/in)	PN (bar/PSI)	Dimensions (mm/in)														Weight (kg/lbs) ca. per 100 ²	Ordering Codes ³
			D1	D2	L	i1	i2	L1 ¹	L2	L3 ¹	L4	L5	L7 _{min}	L7 _{max}	S1	S2		
L	6	315	4	17	48	19	27	12	56	14	27	3	16	12	17	14	4,88	FI-WS-06L-W3-SKM
	.24	4568	.16	.67	1.89	.75	1.06	.47	2.20	.55	1.06	.12	.63	.47	.67	.55	10,74	
	8	315	6	19	51	21	29	14	59	17	27	3	16	12	19	17	6,11	FI-WS-08L-W3-SKM
	.31	4568	.24	.75	2.01	.83	1.14	.55	2.32	.67	1.06	.12	.63	.47	.75	.67	13,43	
	10	315	8	22	53	22	30	15	61	18	28	3	16	14	22	19	7,89	FI-WS-10L-W3-SKM
	.39	4568	.31	.87	2.09	.87	1.18	.59	2.40	.71	1.10	.12	.63	.55	.87	.75	17,35	
	12	315	10	24	56	24	32	17	64	20	29	3	16	17	24	22	9,65	FI-WS-12L-W3-SKM
	.47	4568	.39	.94	2.20	.94	1.26	.67	2.52	.79	1.14	.12	.63	.67	.94	.87	21,23	
	15	315	12	27	61	28	36	21	69	23	31	3	16	19	30	27	16,31	FI-WS-15L-W3-SKM
	.59	4568	.47	1.06	2.40	1.10	1.42	.83	2.72	.91	1.22	.12	.63	.75	1.18	1.06	35,88	
	18	315	15	32	64	31	40	23,5	73	24	32,5	3	16	24	36	32	23,82	FI-WS-18L-W3-SKM
	.71	4568	.59	1.26	2.52	1.22	1.57	.93	2.87	.94	1.28	.12	.63	.94	1.42	1.26	52,40	
	22	250	19	36	72	35	44	27,5	81	30	34,5	4	16	27	41	36	30,41	FI-WS-22L-W3-SKM
	.87	3625	.75	1.42	2.83	1.38	1.73	1.08	3.19	1.18	1.36	.16	.63	1.06	1.61	1.42	66,90	
	28	250	24	42	77	38	47	30,5	86	34	35,5	4	16	36	46	41	45,92	FI-WS-28L-W3-SKM
	1.10	3625	.94	1.65	3.03	1.50	1.85	1.20	3.39	1.34	1.40	.16	.63	1.42	1.81	1.61	101,03	
	35	250	30	50	86	45	56	34,5	97	39	36,5	4	16	41	55	50	75,00	FI-WS-35L-W3-SKM
	1.38	3625	1.18	1.97	3.39	1.77	2.20	1.36	3.82	1.54	1.44	.16	.63	1.61	2.17	1.97	165,00	
	42	250	36	60	90	51	63	40	102	43	36	4	16	50	65	60	107,00	FI-WS-42L-W3-SKM
	1.65	3625	1.42	2.36	3.54	2.01	2.48	1.57	4.02	1.69	1.42	.16	.63	1.97	2.56	2.36	235,40	
S	6	630	4	19	53	23	31	16	61	17	29	3	16	12	19	17	7,34	FI-WS-06S-W3-SKM
	.24	9135	.16	.75	2.09	.91	1.22	.63	2.40	.67	1.14	.12	.63	.47	.75	.67	16,15	
	8	630	5	22	54	24	32	17	62	18	29	3	16	14	22	19	10,16	FI-WS-08S-W3-SKM
	.31	9135	.20	.87	2.13	.94	1.26	.67	2.44	.71	1.14	.12	.63	.55	.87	.75	22,35	
	10	630	7	24	57	25	34	17,5	66	20	29,5	3	16	17	24	22	12,59	FI-WS-10S-W3-SKM
	.39	9135	.28	.94	2.24	.98	1.34	.69	2.60	.79	1.16	.12	.63	.67	.94	.87	27,71	
	12	630	8	27	59	29	38	21,5	68	21	30,5	3	16	17	27	24	16,05	FI-WS-12S-W3-SKM
	.47	9135	.31	1.06	2.32	1.14	1.50	.85	2.68	.83	1.20	.12	.63	.67	1.06	.94	35,30	
	14	630	10	27	63	30	40	22	73	23	32	3	16	19	30	27	19,62	FI-WS-14S-W3-SKM
	.55	9135	.39	1.06	2.48	1.18	1.57	.87	2.87	.91	1.26	.12	.63	.75	1.18	1.06	43,17	
	16	400	12	30	64	33	43	24,5	74	24	31,5	3	16	24	32	30	24,14	FI-WS-16S-W3-SKM
	.63	5800	.47	1.18	2.52	1.30	1.69	.96	2.91	.94	1.24	.12	.63	.94	1.26	1.18	53,10	
	20	400	16	36	74	37	48	26,5	85	30	33,5	4	16	27	41	36	38,01	FI-WS-20S-W3-SKM
	.79	5800	.63	1.42	2.91	1.46	1.89	1.04	3.35	1.18	1.32	.16	.63	1.06	1.61	1.42	83,63	
	25	400	20	42	81	42	54	30	93	34	35	4	16	36	46	46	61,10	FI-WS-25S-W3-SKM
	.98	5800	.79	1.65	3.19	1.65	2.13	1.18	3.66	1.34	1.38	.16	.63	1.42	1.81	1.81	134,42	
	30	400	25	50	90	49	62	35,5	103	39	37,5	4	16	41	50	50	91,00	FI-WS-30S-W3-SKM
	1.18	5800	.98	1.97	3.54	1.93	2.44	1.40	4.06	1.54	1.48	.16	.63	1.61	1.97	1.97	200,20	
	38	315	32	60	96	57	72	41	112	43	37	4	16	50	65	60	138,90	FI-WS-38S-W3-SKM
1.50	4568	1.26	2.36	3.78	2.24	2.83	1.61	4.41	1.69	1.46	.16	.63	1.97	2.56	2.36	305,58		

¹ Approximate dimension in assembled condition.
² Weight excluding cutting rings and union nuts.
³ Standard scope of delivery: Fitting body only.

Ordering Codes

***FI-WS*-10*L*-W3*-MS**

- * Elbow Bulkhead Fitting **FI-WS**
- * Outside Tube Diameter D1 (in mm) **-10**
- * Series Light Series **L**
Heavy Series **S**
- * Material Code Steel, zinc/nickel-plated **-W3**

Please contact STAUFF for alternative materials and surface finishings.

- * Assembling / Kitting Fitting body only **—**
- Fitting body supplied with hexagon lock nut **-SKM**
- Fitting body supplied with cutting rings and union nuts **-MS**
- Fitting body supplied with soft-sealing cutting rings and union nuts **-MSV**

Connecting Parts

- Cutting Ring Type **FI-DS** Page 26
- Soft-Sealing Cutting Ring Type **FI-WDDS** Page 27
- Support Sleeve Type **FI-VH** Page 28
- STAUFF Form Ring Type **FI-AR** Page 30
- Union Nut Type **FI-M** Page 31
- 37° Flared Tube Fitting Set Type **FI-AB** Page 35

Spare Parts / Accessories

- Hexagon Lock Nut Type **FI-SKM** Page 205



Straight Bulkhead Weld Fitting Type FI-ES • Series L / S

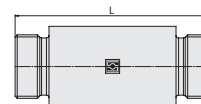
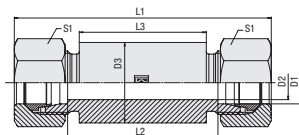

Ordering Codes

FI-ES-10*L*-W159*-MS

- * Straight Bulkhead Weld Fitting **FI-ES**
- * Outside Tube Diameter D1 (in mm) **-10**
- * Series **L**
Light Series
Heavy Series **S**
- * Material Code **-W2**
Steel, phosphated
Fitting body:
Steel, phosphated **-W159**
Connecting parts:
Steel, zinc/nickel-plated
- Please contact STAUFF for alternative materials and surface finishings.
- * Assembling / Kitting **—**
Fitting body only
Fitting body supplied with cutting rings and union nuts **-MS**
Fitting body supplied with soft-sealing cutting rings and union nuts **-MSV**

Connecting Parts

-  Cutting Ring
Type **FI-DS** Page 26
-  Soft-Sealing Cutting Ring
Type **FI-WDDS** Page 27
-  Support Sleeve
Type **FI-VH** Page 28
-  STAUFF Form Ring
Type **FI-AR** Page 30
-  Union Nut
Type **FI-M** Page 31
-  37° Flared Tube Fitting Set
Type **FI-AB** Page 35

Series	Tube OD	PN	Dimensions							Weight (kg/lbs) ca. per 100 ²	Ordering Codes ³
	(mm/in) D1		(mm/in) D2	(mm/in) D3	L	L1 ¹	L2	L3	S1		
L	6	315	4	18	70	85	56	50	14	10,33	FI-ES-06L-W2
	.24	4568	.16	.71	2.76	3.35	2.20	1.97	.55	22.73	
	8	315	6	20	70	85	56	50	17	12,21	FI-ES-08L-W2
	.31	4568	.24	.79	2.76	3.35	2.20	1.97	.67	26.87	
	10	315	8	22	72	87	58	50	19	14,30	FI-ES-10L-W2
	.39	4568	.31	.87	2.83	3.43	2.28	1.97	.75	31.46	
	12	315	10	25	72	87	58	50	22	17,75	FI-ES-12L-W2
	.47	4568	.39	.98	2.83	3.43	2.28	1.97	.87	39.05	
	15	315	12	28	84	100	70	60	27	26,69	FI-ES-15L-W2
	.59	4568	.47	1.10	3.31	3.94	2.76	2.36	1.06	58.73	
	18	315	15	32	84	101	69	60	32	33,60	FI-ES-18L-W2
	.71	4568	.59	1.26	3.31	3.98	2.72	2.36	1.26	73.92	
	22	160	19	36	88	105	73	60	36	39,92	FI-ES-22L-W2
	.87	2320	.75	1.42	3.46	4.13	2.87	2.36	1.42	87.83	
	28	160	24	40	88	106	73	60	41	45,18	FI-ES-28L-W2
	1.10	2320	.94	1.57	3.46	4.17	2.87	2.36	1.61	99.40	
	35	160	30	50	92	114	71	60	50	72,80	FI-ES-35L-W2
	1.38	2320	1.18	1.97	3.62	4.49	2.80	2.36	1.97	160.16	
	42	160	36	60	92	115	70	60	60	100,60	FI-ES-42L-W2
	1.65	2320	1.42	2.36	3.62	4.53	2.76	2.36	2.36	221.32	
S	6	630	4	20	74	89	60	50	17	13,56	FI-ES-06S-W2
	.24	9135	.16	.79	2.91	3.50	2.36	1.97	.67	29.83	
	8	630	5	22	74	89	60	50	19	16,35	FI-ES-08S-W2
	.31	9135	.20	.87	2.91	3.50	2.36	1.97	.75	35.96	
	10	630	7	25	74	91	59	50	22	20,24	FI-ES-10S-W2
	.39	9135	.28	.98	2.91	3.58	2.32	1.97	.87	44.52	
	12	630	8	28	74	91	59	50	24	25,17	FI-ES-12S-W2
	.47	9135	.31	1.10	2.91	3.58	2.32	1.97	.94	55.38	
	14	630	10	30	88	107	72	60	27	33,72	FI-ES-14S-W2
	.55	9135	.39	1.18	3.46	4.21	2.83	2.36	1.06	74.18	
	16	400	12	35	88	107	71	60	30	44,42	FI-ES-16S-W2
	.63	5800	.47	1.38	3.46	4.21	2.80	2.36	1.18	97.72	
	20	400	16	38	92	114	71	60	36	51,50	FI-ES-20S-W2
	.79	5800	.63	1.50	3.62	4.49	2.80	2.36	1.42	113.30	
	25	400	20	45	96	120	72	60	46	72,50	FI-ES-25S-W2
	.98	5800	.79	1.77	3.78	4.72	2.83	2.36	1.81	159.50	
	30	400	25	50	100	126	73	60	50	87,80	FI-ES-30S-W2
	1.18	5800	.98	1.97	3.94	4.96	2.87	2.36	1.97	193.16	
38	315	32	60	104	133	72	60	60	125,30	FI-ES-38S-W2	
1.50	4568	1.26	2.36	4.09	5.24	2.83	2.36	2.36	275.66		

¹ Approximate dimension in assembled condition.

² Weight excluding cutting rings and union nuts.

³ Standard scope of delivery: Fitting body only.



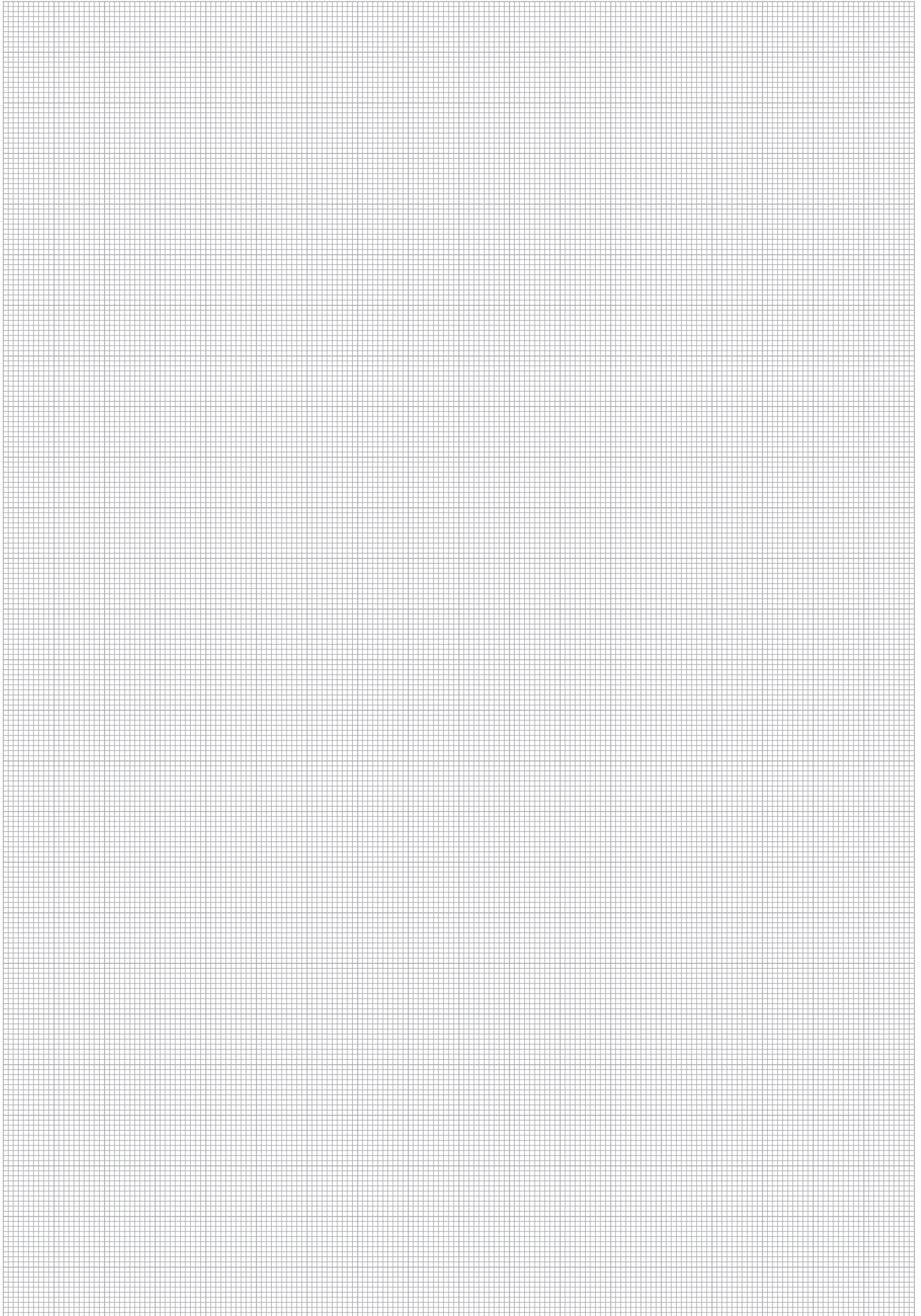



	Straight Weld Fitting FI-AS	98
	Elbow Weld Fitting FI-WAS	99
	24° Weld Cone with O-Ring FI-SN	100
	24° Weld Cone Reducer with O-Ring FI-SNR	102
	Straight Weld Fitting for Tubes FI-ASV	104



Straight Weld Fitting
Type FI-AS • Series L / S

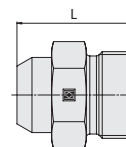
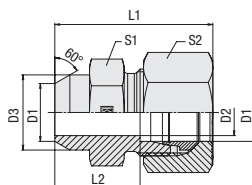

Ordering Codes

***FI-AS*-10*L*-W159*-MS**

- * Straight Weld Fitting **FI-AS**
- * Outside Tube Diameter D1 (in mm) **-10**
- * Series **L**
Light Series **S**
Heavy Series
- * Material Code **-W2**
Steel, phosphated
- Fitting body: **-W159**
Steel, phosphated
- Connecting parts: **-MSV**
Steel, zinc/nickel-plated
- Please contact STAUFF for alternative materials and surface finishings.
- * Assembling / Kitting **—**
Fitting body only
- Fitting body supplied with cutting ring and union nut **-MS**
- Fitting body supplied with soft-sealing cutting ring and union nut **-MSV**

Connecting Parts

- Cutting Ring
Type **FI-DS** Page 26
- Soft-Sealing Cutting Ring
Type **FI-WDDS** Page 27
- Support Sleeve
Type **FI-VH** Page 28
- STAUFF Form Ring
Type **FI-AR** Page 30
- Union Nut
Type **FI-M** Page 31
- 37° Flared Tube Fitting Set
Type **FI-AB** Page 35

Series	Tube OD (mm/in)	PN (bar/psi)	Dimensions (mm/in)								Weight (kg/lbs) ca. per 100 ²	Ordering Codes ³
			D1	D2	D3	L	L ¹	L2	S1	S2		
L	6	315	4	10	21	29	14	12	14	1.06	FI-AS-06L-W2	
	.24	4568	.16	.39	.83	1.14	.55	.47	.55	2.33	FI-AS-08L-W2	
	8	315	6	12	23	31	16	14	17	1.52	FI-AS-10L-W2	
	.31	4568	.24	.47	.91	1.22	.63	.55	.67	3.35	FI-AS-12L-W2	
	10	315	8	14	25	33	18	17	19	2.20	FI-AS-15L-W2	
	.39	4568	.31	.55	.98	1.30	.71	.67	.75	4.83	FI-AS-18L-W2	
	12	315	10	16	25	33	18	19	22	2.57	FI-AS-22L-W2	
	.47	4568	.39	.63	.98	1.30	.71	.75	.87	5.66	FI-AS-28L-W2	
	15	315	12	19	29	37	22	22	27	4.37	FI-AS-35L-W2	
	.59	4568	.47	.75	1.14	1.46	.87	.87	1.06	9.62	FI-AS-42L-W2	
	18	315	15	22	31	40	23.5	27	32	6.70	FI-AS-42L-W2	
	.71	4568	.59	.87	1.22	1.57	.93	1.06	1.26	14.75	FI-AS-42L-W2	
	22	160	19	27	36	45	28.5	32	36	9.87	FI-AS-22L-W2	
	.87	2320	.75	1.06	1.42	1.77	1.12	1.26	1.42	21.72	FI-AS-28L-W2	
	28	160	24	32	38	47	30.5	41	41	16.10	FI-AS-35L-W2	
	1.10	2320	.94	1.26	1.50	1.85	1.20	1.61	1.61	35.42	FI-AS-42L-W2	
	35	160	30	40	43	54	32.5	46	50	23.43	FI-AS-42L-W2	
	1.38	2320	1.18	1.57	1.69	2.13	1.28	1.81	1.97	51.55	FI-AS-42L-W2	
	42	160	36	46	46	58	35	55	60	32.82	FI-AS-42L-W2	
	1.65	2320	1.42	1.81	1.81	2.28	1.38	2.17	2.36	72.21	FI-AS-42L-W2	
S	6	630	4	11	26	34	19	14	17	2.06	FI-AS-06S-W2	
	.24	9135	.16	.43	1.02	1.34	.75	.55	.67	4.53	FI-AS-08S-W2	
	8	630	5	13	28	36	21	17	19	3.12	FI-AS-10S-W2	
	.31	9135	.20	.51	1.10	1.42	.83	.67	.75	6.87	FI-AS-12S-W2	
	10	630	7	15	30	39	22.5	19	22	4.12	FI-AS-14S-W2	
	.39	9135	.28	.59	1.18	1.54	.89	.75	.87	9.06	FI-AS-16S-W2	
	12	630	8	17	32	41	24.5	22	24	4.80	FI-AS-20S-W2	
	.47	9135	.31	.67	1.26	1.61	.96	.87	.94	10.56	FI-AS-25S-W2	
	14	630	10	19	35	45	27	24	27	7.11	FI-AS-30S-W2	
	.55	9135	.39	.75	1.38	1.77	1.06	.94	1.06	15.64	FI-AS-38S-W2	
	16	400	12	21	35	45	26.5	27	30	8.36	FI-AS-20S-W2	
	.63	5800	.47	.83	1.38	1.77	1.04	1.06	1.18	18.38	FI-AS-25S-W2	
	20	400	16	26	40	51	29.5	32	36	13.01	FI-AS-30S-W2	
	.79	5800	.63	1.02	1.57	2.01	1.16	1.26	1.42	28.61	FI-AS-38S-W2	
	25	400	20	31	44	56	32	41	46	22.16	FI-AS-38S-W2	
.98	5800	.79	1.22	1.73	2.20	1.26	1.61	1.81	48.75	FI-AS-38S-W2		
30	400	25	36	49	62	35.5	46	50	23.12	FI-AS-38S-W2		
1.18	5800	.98	1.42	1.93	2.44	1.40	1.81	1.97	50.86	FI-AS-38S-W2		
38	315	32	44	54	69	38	55	60	45.26	FI-AS-38S-W2		
1.50	4568	1.26	1.73	2.13	2.72	1.50	2.17	2.36	99.57	FI-AS-38S-W2		

¹ Approximate dimension in assembled condition.

² Weight excluding cutting ring and union nut.

³ Standard scope of delivery: Fitting body only.

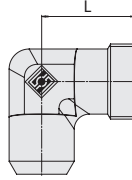
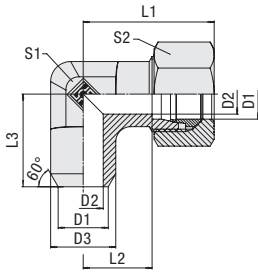

**Elbow Weld Fitting
Type FI-WAS • Series L / S**

Series	Tube OD (mm/in)	PN (bar/PSI)	Dimensions (mm/in)								Weight (kg/lbs) ca. per 100 ²	Ordering Codes ³
			D1	D2	D3	L	L1 ¹	L2	L3	S1		
L	6	315	4	10	19	28	12	19	12	14	23	FI-WAS-06L-W2
	.24	4568	.16	.39	.75	1.10	.47	.75	.47	.55	50.71	
	8	315	6	12	21	29	14	23	12	17	2,56	FI-WAS-08L-W2
	.31	4568	.24	.47	.83	1.14	.55	.91	.47	.67	5.64	
	10	315	8	14	22	30	15	24	14	19	3,34	FI-WAS-10L-W2
	.39	4568	.31	.55	.87	1.18	.59	.94	.55	.75	7.34	
	12	315	10	16	24	32	17	25	17	22	4,52	FI-WAS-12L-W2
	.47	4568	.39	.63	.94	1.26	.67	.98	.67	.87	9.94	
	15	315	12	19	28	36	21	30	19	27	7,88	FI-WAS-15L-W2
	.59	4568	.47	.75	1.10	1.42	.83	1.18	.75	1.06	17.34	
	18	315	15	22	31	40	23,5	33	24	32	11,53	FI-WAS-18L-W2
	.71	4568	.59	.87	1.22	1.57	.93	1.30	.94	1.26	25.37	
	22	160	19	27	35	44	27,5	37	27	36	16,10	FI-WAS-22L-W2
	.87	2320	.75	1.06	1.38	1.73	1.08	1.46	1.06	1.42	35.41	
	28	160	24	32	38	47	30,5	42	36	41	5,99	FI-WAS-28L-W2
	1.10	2320	.94	1.26	1.50	1.85	1.20	1.65	1.42	1.61	13.17	
	35	160	30	40	45	56	34,5	49	41	50	42,27	FI-WAS-35L-W2
	1.38	2320	1.18	1.57	1.77	2.20	1.36	1.93	1.61	1.97	92.99	
42	160	36	46	51	63	40	57	50	60	65,80	FI-WAS-42L-W2	
1.65	2320	1.42	1.81	2.01	2.48	1.57	2.24	1.97	2.36	144.76		
S	6	400	4	11	23	30	16	23	12	17	30,96	FI-WAS-06S-W2
	.24	5800	.16	.43	.91	1.18	.63	.91	.47	.67	68.26	
	8	400	5	13	24	31	17	24	14	19	43,75	FI-WAS-08S-W2
	.31	5800	.20	.51	.94	1.22	.67	.94	.55	.75	96.45	
	10	400	7	15	25	33	17,5	25	17	22	56,74	FI-WAS-10S-W2
	.39	5800	.28	.59	.98	1.30	.69	.98	.67	.87	125.10	
	12	400	8	17	29	38	21,5	29	17	24	8,03	FI-WAS-12S-W2
	.47	5800	.31	.67	1.14	1.50	.85	1.14	.67	.94	17.67	
	16	400	12	21	33	43	24,5	33	24	30	13,89	FI-WAS-16S-W2
	.63	5800	.47	.83	1.30	1.69	.96	1.30	.94	1.18	30.56	
	20	400	16	26	37	48	26,5	37	27	36	20,24	FI-WAS-20S-W2
	.79	5800	.63	1.02	1.46	1.89	1.04	1.46	1.06	1.42	44.54	
	25	400	20	31	42	54	30	42	36	46	35,01	FI-WAS-25S-W2
	.98	5800	.79	1.22	1.65	2.13	1.18	1.65	1.42	1.81	77.03	
	30	400	25	36	49	62	35,5	49	41	50	53,00	FI-WAS-30S-W2
1.18	5800	.98	1.42	1.93	2.44	1.40	1.93	1.61	1.97	116.60		
38	315	32	44	57	72	41	57	50	60	83,70	FI-WAS-38S-W2	
1.50	4568	1.26	1.73	2.24	2.83	1.61	2.24	1.97	2.36	184.14		

¹ Approximate dimension in assembled condition.

² Weight excluding cutting ring and union nut.

³ Standard scope of delivery: Fitting body only.

Ordering Codes
***FI-WAS*-10*L*-W159*-MS**

* Elbow Weld Fitting	FI-WAS
* Outside Tube Diameter D1 (in mm)	-10
* Series	Light Series L Heavy Series S
* Material Code	Steel, phosphated -W2
	Fitting body: Steel, phosphated -W159
	Connecting parts: Steel, zinc/nickel-plated

Please contact STAUFF for alternative materials and surface finishings.

* Assembling / Kitting	Fitting body only	—
	Fitting body supplied with cutting ring and union nut	-MS
	Fitting body supplied with soft-sealing cutting ring and union nut	-MSV

Connecting Parts

	Cutting Ring Type FI-DS	Page 26
	Soft-Sealing Cutting Ring Type FI-WDDS	Page 27
	Support Sleeve Type FI-VH	Page 28
	STAUFF Form Ring Type FI-AR	Page 30
	Union Nut Type FI-M	Page 31
	37° Flared Tube Fitting Set Type FI-AB	Page 35



24° Weld Cone with O-Ring Type FI-SN • Series L / S

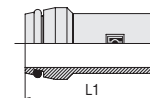
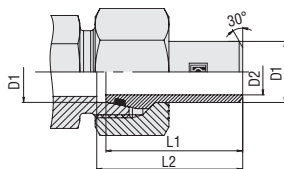

Ordering Codes

FI-SN-10x1.5*-B*-W161

- * 24° Weld Cone with O-Ring **FI-SN**
- * Outside Tube Diameter (in mm) **-10**
- * Wall Thickness (in mm) **x1.5**
- * Seal Material NBR (Buna-N®) **-B**
FKM (Viton®) **-V**
EPDM **-E**
- * Material Code Steel, phosphated **-W2**

Please contact STAUFF for alternative materials and surface finishings.

FI-SN-10*L*x1.5*-B*-W159*-M

- * 24° Weld Cone with O-Ring **FI-SN**
- * Outside Tube Diameter (in mm) **-10**
- * Series Light Series (page 100) **L**
Heavy Series (pages 100/101) **S**
- * Wall Thickness (in mm) **x1.5**
- * Seal Material NBR (Buna-N®) **-B**
FKM (Viton®) **-V**
EPDM **-E**
- * Material Code Weld cone:
Steel, phosphated **-W159**
Union nut:
Steel, zinc/nickel-plated

Please contact STAUFF for alternative materials and surface finishings.

- * Assembling / Kitting 24° weld cone with O-ring supplied with union nut **-M**

Series	Tube OD		PN (^{bar} /psi)	Dimensions			Weight (^{kg} /lbs) ca. per 100 ²	Ordering Codes ³
	D1	for Tube		D2	L1	L2		
L/S	6	6 x 1,5	400	3	31	32	0,70	FI-SN-06x1.5-B-W2
	.24	.24 x .06	5800	.12	1.22	1.26	1.54	
	8	8 x 1,5	315	5	31	32	0,90	FI-SN-08x1.5-B-W2
	.31	.31 x .06	4568	.20	1.22	1.26	1.98	
	8	8 x 2	400	4	31	32	1,10	FI-SN-08x2-B-W2
	.31	.31 x .08	5800	.16	1.22	1.26	2.42	
	10	10 x 1,5	250	7	32,5	33,5	1,30	FI-SN-10x1.5-B-W2
	.39	.39 x .06	3625	.28	1.28	1.32	2.86	
	10	10 x 2	315	6	32,5	33,5	1,60	FI-SN-10x2-B-W2
	.39	.39 x .08	4568	.24	1.28	1.32	3.52	
	10	10 x 2,5	400	5	32,5	33,5	1,80	FI-SN-10x2.5-B-W2
	.39	.39 x .10	5800	.20	1.28	1.32	3.96	
	12	12 x 1,5	160	9	32,5	33,5	1,60	FI-SN-12x1.5-B-W2
	.47	.47 x .06	2320	.35	1.28	1.32	3.52	
	12	12 x 2	250	8	32,5	33,5	1,90	FI-SN-12x2-B-W2
	.47	.47 x .08	3625	.31	1.28	1.32	4.18	
12	12 x 2,5	315	7	32,5	33,5	2,20	FI-SN-12x2.5-B-W2	
.47	.47 x .10	4568	.28	1.28	1.32	4.84		
L	15	15 x 2	250	11	35	36	2,70	FI-SN-15x2-B-W2
	.59	.59 x .08	3625	.43	1.38	1.42	5.93	
	15	15 x 2,5	315	10	35	36	3,00	FI-SN-15x2.5-B-W2
	.59	.59 x .10	4568	.39	1.38	1.42	6.60	
	18	18 x 2	160	14	36	37	3,76	FI-SN-18x2-B-W2
	.71	.71 x .08	2320	.55	1.42	1.46	8.27	
	22	22 x 2,5	160	17	38,5	39,5	5,21	FI-SN-22x2.5-B-W2
	.87	.87 x .10	2320	.67	1.52	1.56	11.45	
	28	28 x 2,5	100	23	41,5	42,5	7,27	FI-SN-28x2.5-B-W2
	1.10	1.10 x .10	1450	.91	1.63	1.67	15.99	
	28	28 x 3	160	22	41,5	42,5	8,34	FI-SN-28x3-B-W2
	1.10	1.1 x .12	2320	.87	1.63	1.67	18.34	
	35	35 x 3	100	29	47	49,5	12,62	FI-SN-35x3-B-W2
	1.38	1.38 x .12	1450	1.14	1.85	1.95	27.76	
	35	35 x 4	160	27	47	49,5	15,59	FI-SN-35x4-B-W2
	1.38	1.38 x .16	2320	1.06	1.85	1.95	34.30	
	42	42 x 3	100	36	47	50	15,13	FI-SN-42x3-B-W2
	1.65	1.65 x .12	1450	1.42	1.85	1.97	33.29	
42	42 x 4	160	34	47	50	19,10	FI-SN-42x4-B-W2	
1.65	1.65 x .16	2320	1.34	1.85	1.97	42.02		

Connecting Parts



Union Nut
Type FI-M

Page 31

Spare Parts / Accessories



O-Ring
Type O-RING

Page 207

¹ Approximate dimension in assembled condition.

² Weight excluding union nut.

³ Standard scope of delivery: 24° weld cone and O-ring.

Standard seal material is NBR (Buna-N®).

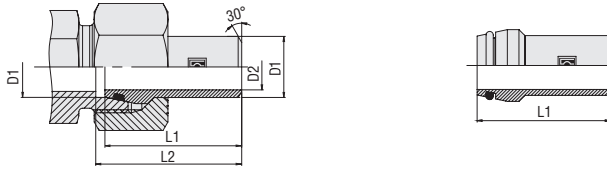

**24° Weld Cone with O-Ring
Type SN • Series S**

Series	Tube OD		PN (bar/psi)	Dimensions			Weight (^{kg} /lbs) ca. per 100 ²	Ordering Codes ³
	D1 (mm/in)	for Tube		D2 (mm/in)	L1	L2		
S	14	14 x 2,5	315	9	38,5	39,5	3,17	FI-SN-14x2.5-B-W2
	.55	.55 x .10	4568	.35	1.52	1.56	6.98	
	14	14 x 3	400	8	38,5	39,5	3,56	FI-SN-14x3-B-W2
	.55	.55 x .12	5800	.31	1.52	1.56	7.83	
	16	16 x 2	250	12	39	41	3,29	FI-SN-16x2-B-W2
	.63	.63 x .08	3625	.47	1.54	1.61	7.24	FI-SN-16x2.5-B-W2
	16	16 x 2,5	315	11	39	41	3,81	
	.63	.63 x .10	4568	.43	1.54	1.61	8.38	FI-SN-16x3-B-W2
	16	16 x 3	400	10	39	41	4,23	
	.63	.63 x .12	5800	.39	1.54	1.61	9.31	FI-SN-20x2-B-W2
	20	20 x 2	160	16	44,5	47	4,77	
	.79	.79 x .08	2320	.63	1.75	1.85	10.50	FI-SN-20x2.5-B-W2
	20	20 x 2,5	250	15	44,5	47	5,48	
	.79	.79 x .10	3625	.59	1.75	1.85	12.05	FI-SN-20x3-B-W2
	20	20 x 3	315	14	44,5	47	6,39	
	.79	.79 x .12	4568	.55	1.75	1.85	14.05	FI-SN-20x4-B-W2
	20	20 x 4	400	12	44,5	47	7,73	
	.79	.79 x .16	5800	.47	1.75	1.85	17.01	FI-SN-25x3-B-W2
	25	25 x 3	250	19	49,5	53,5	9,00	
	.98	.98 x .12	3625	.75	1.95	2.11	19.80	FI-SN-25x4-B-W2
	25	25 x 4	315	17	49,5	53,5	10,89	
	.98	.98 x .16	4568	.67	1.95	2.11	23.97	FI-SN-25x5-B-W2
	25	25 x 5	400	15	49,5	53,5	12,90	
	.98	.98 x .20	5800	.59	1.95	2.11	28.38	FI-SN-30x3-B-W2
	30	30 x 3	160	24	52	57,5	11,55	
	1.18	1.18 x .12	2320	.94	2.05	2.26	25.40	FI-SN-30x4-B-W2
	30	30 x 4	250	22	52	57,5	14,65	
	1.18	1.18 x .16	3625	.87	2.05	2.26	32.23	FI-SN-30x5-B-W2
	30	30 x 5	315	20	52	57,5	16,91	
	1.18	1.18 x .20	4568	.79	2.05	2.26	37.21	FI-SN-38x4-B-W2
38	38 x 4	160	30	56,5	64,5	20,29		
1.50	1.50 x .16	2320	1.18	2.22	2.54	44.64	FI-SN-38x5-B-W2	
38	38 x 5	250	28	56,5	64,5	24,05		
1.50	1.50 x .20	3625	1.10	2.22	2.54	52.91	FI-SN-38x6-B-W2	
38	38 x 6	315	26	56,5	64,5	27,91		
1.50	1.50 x .24	4568	1.02	2.22	2.54	61.41		

¹ Approximate dimension in assembled condition.

² Weight excluding union nut.

³ Standard scope of delivery: 24° weld cone and O-ring.

Standard seal material is NBR (Buna-N®).

Ordering Codes
***FI-SN*-10x1.5*-B*-W2**

* 24° Weld Cone with O-Ring	FI-SN
* Outside Tube Diameter (in mm)	-10
* Wall Thickness (in mm)	x1.5
* Seal Material	NBR (Buna-N®) -B FKM (Viton®) -V EPDM -E
* Material Code	Steel, phosphated -W2

Please contact STAUFF for alternative materials and surface finishings.

***FI-SN*-10Lx1.5*-B*-W159*-M**

* 24° Weld Cone with O-Ring	FI-SN
* Outside Tube Diameter (in mm)	-10
* Wall Thickness (in mm)	x1.5
* Series	Light Series (page 100) L Heavy Series (pages 100/101) S
* Seal Material	NBR (Buna-N®) -B FKM (Viton®) -V EPDM -E
* Material Code	Weld cone: Steel, phosphated Union nut: Steel, zinc/nickel-plated -W159

Please contact STAUFF for alternative materials and surface finishings.

* Assembling / Kitting	24° weld cone with O-ring supplied with union nut	-M
------------------------	---	----

Connecting Parts

 Union Nut
Type FI-M

Page 31

Spare Parts / Accessories

 O-Ring
Type O-RING

Page 207



24° Weld Cone Reducer with O-Ring Type FI-SNR • Series L / S

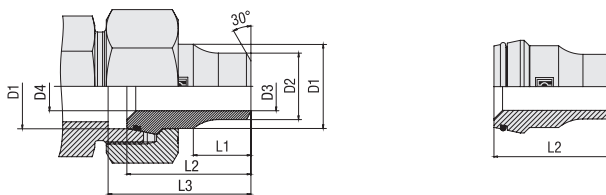

Ordering Codes

FI-SNR-10/*08*x2.5*-B*-W2

- * 24° Weld Cone Reducer with O-Ring **FI-SNR**
- * Outside Tube Diameter D1 (in mm) **-10/**
- * Outside Tube Diameter D2 (in mm) **-08**
- * Wall Thickness (in mm) **x2.5**
- * Seal Material NBR (Buna-N®) **-B**
FKM (Viton®) **-V**
EPDM **-E**
- * Material Code Steel, phosphated **-W2**

Please contact STAUFF for alternative materials and surface finishings.

FI-SNR-10*L*08*x2.5*-B*-W159*-M

- * 24° Weld Cone Reducer with O-Ring **FI-SNR**
- * Outside Tube Diameter D1 (in mm) **-10**
- * Series Light Series **L**
Heavy Series **S**
- * Outside Tube Diameter D2 (in mm) **-08**
- * Wall Thickness (in mm) **x2.5**
- * Seal Material NBR (Buna-N®) **-B**
FKM (Viton®) **-V**
EPDM **-E**
- * Material Code Weld cone:
Steel, phosphated **-W159**
Union nut:
Steel, zinc/nickel-plated

Please contact STAUFF for alternative materials and surface finishings.

- * Assembling / Kitting 24° weld cone with O-ring supplied with union nut **-M**

Series	Tube OD		PN (bar/psi)	Dimensions (mm/in)						Weight (kg/lbs) ca. per 100 ²	Ordering Codes ³
	D1	for Tube		D2	D3	D4	L1	L2	L3		
L/S	8	6 x 2,0	400	6	2	5	12	31	32	1,45	FI-SNR-08/06x2.0-B-W2
	.31	.24 x .08	5800	.24	.08	.20	.47	1.22	1.26	3.19	
	10	8 x 2,5	400	8	3	6,50	12	32,5	33,5	1,75	FI-SNR-10/08x2.5-B-W2
	.39	.31 x .10	5800	.31	.12	.26	.47	1.28	1.32	3.85	
	12	10 x 3,0	400	10	4	8	14	32,5	33,5	2,19	FI-SNR-12/10x3.0-B-W2
.47	.39 x .12	5800	.39	.16	.31	.55	1.28	1.32	4.82		
S	14	12 x 3,5	400	12	5	9	15	38,5	39,5	3,56	FI-SNR-14/12x3.5-B-W2
	.55	.47 x .14	5800	.47	.20	.35	.59	1.52	1.56	7.83	
	16	12 x 2,0	250	12	8	11	17	38,5	41	4,70	FI-SNR-16/12x2.0-B-W2
	.63	.47 x .08	3625	.47	.31	.43	.67	1.52	1.61	10.34	
	20	16 x 3,0	315	16	10	14	17	44,5	47	7,73	FI-SNR-20/16x3.0-B-W2
	.79	.63 x .12	4568	.63	.39	.55	.67	1.75	1.85	17.01	
	30	25 x 5,0	315	25	15	22	22	52	57,5	16,91	FI-SNR-30/25x5.0-B-W2
	1.18	.98 x .20	4568	.98	.59	.87	.87	2.05	2.26	37.21	

¹ Approximate dimension in assembled condition.

² Weight excluding union nut.

³ Standard scope of delivery: 24° weld cone and O-ring.

Standard seal material is NBR (Buna-N®).

Connecting Parts



Union Nut
Type FI-M

Page 31

Spare Parts / Accessories



O-Ring
Type O-RING

Page 207



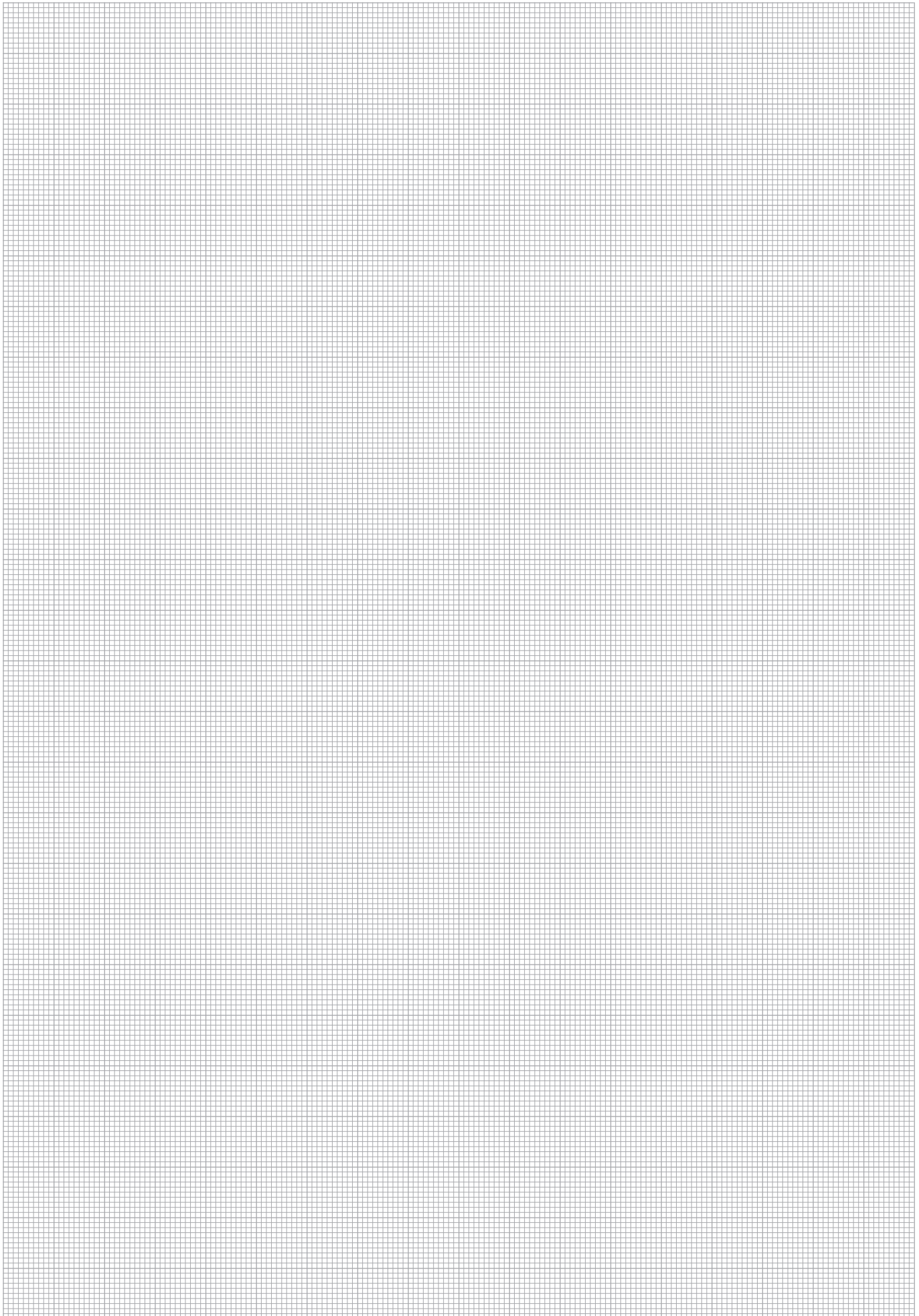

F



Straight Weld Fitting for Tubes Type FI-ASV • Series S

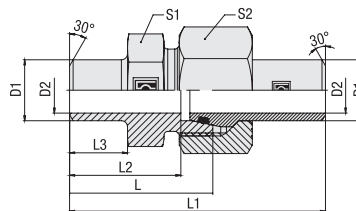

Ordering Codes

***FI-ASV*-06*S*x1.5*-B*-W159*-MSN**

- * Straight Weld Fitting for Tubes **FI-ASV**
- * Outside Tube Diameter (in mm) **-06**
- * Series Heavy Series **S**
- * Wall Thickness (in mm) **x1.5**
- * Seal Material NBR (Buna-N®) **-B**
FKM (Viton®) **-V**
EPDM **-E**
- * Material Code Steel, phosphated **-W2**
Fitting body / weld cone: Steel, phosphated **-W159**
Union nut: Steel, zinc/nickel-plated

Please contact STAUFF for alternative materials and surface finishings.

- * Assembling / Kitting Straight weld fitting for tubes supplied with 24° weld cone with O-ring and union nut **-MSN**

Connecting Parts



Union Nut
Type **FI-M**

Page 31

Spare Parts / Accessories



O-Ring
Type **O-RING**

Page 207

Series	Tube OD		PN (bar/psi)	Dimensions							Weight (kg/lbs) ca. per 100 ²	Ordering Codes ³
	D1	for Tube		D2	L	L1 ¹	L2	L3	S1	S2		
S	10	10 x 1	249	8	32	58	24,5	10	19	22	8,11	FI-ASV-10Sx1-B-W159-MSN
	.39	.39 x .04	3610	.31	1.26	2.28	.96	.39	.75	.87	17.84	FI-ASV-10Sx1.5-B-W159-MSN
10	10 x 1,5	358	7	32	58	24,5	10	19	22	8,54	FI-ASV-10Sx2-B-W159-MSN	
.39	.39 x .06	5191	.28	1.26	2.28	.96	.39	.75	.87	18.79	FI-ASV-10Sx2.5-B-W159-MSN	
10	10 x 2	460	6	32	58	24,5	10	19	22	8,99	FI-ASV-12Sx1.5-B-W159-MSN	
.39	.39 x .08	6670	.24	1.26	2.28	.96	.39	.75	.87	19.78	FI-ASV-12Sx2-B-W159-MSN	
12	12 x 1,5	305	9	37	63	29,5	15	22	24	10,47	FI-ASV-12Sx2.5-B-W159-MSN	
.47	.47 x .06	4423	.35	1.46	2.48	1.16	.59	.87	.94	23.03	FI-ASV-16Sx1.5-B-W159-MSN	
12	12 x 2	393	8	37	63	29,5	15	22	24	11,00	FI-ASV-16Sx2-B-W159-MSN	
.47	.47 x .08	5699	.31	1.46	2.48	1.16	.59	.87	.94	24.20	FI-ASV-16Sx2.5-B-W159-MSN	
12	12 x 2,5	476	7	37	63	29,5	15	22	24	11,54	FI-ASV-16Sx3-B-W159-MSN	
.47	.47 x .10	6902	.28	1.46	2.48	1.16	.59	.87	.94	25.39	FI-ASV-16Sx3.5-B-W159-MSN	
16	16 x 1,5	234	13	41,5	74	33	16,5	27	30	17,40	FI-ASV-16Sx4-B-W159-MSN	
.63	.63 x .06	3393	.51	1.63	2.91	1.30	.65	1.06	1.18	38.28	FI-ASV-16Sx4.5-B-W159-MSN	
16	16 x 2	305	12	41,5	74	33	16,5	27	30	18,30	FI-ASV-16Sx5-B-W159-MSN	
.63	.63 x .08	4423	.47	1.63	2.91	1.30	.65	1.06	1.18	40.26	FI-ASV-16Sx5.5-B-W159-MSN	
16	16 x 2,5	372	11	41,5	74	33	16,5	27	30	19,27	FI-ASV-16Sx6-B-W159-MSN	
.63	.63 x .10	5394	.43	1.63	2.91	1.30	.65	1.06	1.18	42.39	FI-ASV-16Sx6.5-B-W159-MSN	
16	16 x 3	400	10	41,5	74	33	16,5	27	30	20,09	FI-ASV-16Sx7-B-W159-MSN	
.63	.63 x .12	5800	.39	1.63	2.91	1.30	.65	1.06	1.18	44.20	FI-ASV-20Sx2-B-W159-MSN	
20	20 x 2	249	16	47	84	36,5	19	32	36	28,18	FI-ASV-20Sx2.5-B-W159-MSN	
.79	.79 x .08	3611	.63	1.85	3.31	1.44	.75	1.26	1.42	62.00	FI-ASV-20Sx3-B-W159-MSN	
20	20 x 2,5	305	15	47	84	36,5	19	32	36	29,67	FI-ASV-20Sx3.5-B-W159-MSN	
.79	.79 x .10	4423	.59	1.85	3.31	1.44	.75	1.26	1.42	65.27	FI-ASV-20Sx4-B-W159-MSN	
20	20 x 3	358	14	47	84	36,5	19	32	36	31,08	FI-ASV-20Sx4.5-B-W159-MSN	
.79	.79 x .12	5191	.55	1.85	3.31	1.44	.75	1.26	1.42	68.38	FI-ASV-25Sx3-B-W159-MSN	
20	20 x 4	400	12	47	84	36,5	19	32	36	33,10	FI-ASV-25Sx3.5-B-W159-MSN	
.79	.79 x .16	5800	.47	1.85	3.31	1.44	.75	1.26	1.42	72.82	FI-ASV-25Sx4-B-W159-MSN	
25	25 x 3	294	19	51,5	93	39,5	19,5	41	46	53,44	FI-ASV-25Sx4.5-B-W159-MSN	
.98	.98 x .12	4263	.75	2.03	3.66	1.56	.77	1.61	1.81	117.57	FI-ASV-25Sx5-B-W159-MSN	
25	25 x 4	379	17	51,5	93	39,5	19,5	41	46	57,29	FI-ASV-25Sx5.5-B-W159-MSN	
.98	.98 x .16	5496	.67	2.03	3.66	1.56	.77	1.61	1.81	126.04	FI-ASV-30Sx3-B-W159-MSN	
25	25 x 5	400	15	51,5	93	39,5	19,5	41	46	59,90	FI-ASV-30Sx3.5-B-W159-MSN	
.98	.98 x .20	5800	.59	2.03	3.66	1.56	.77	1.61	1.81	131.78	FI-ASV-30Sx4-B-W159-MSN	
30	30 x 3	249	24	58	102	44,5	23	46	50	66,38	FI-ASV-30Sx4.5-B-W159-MSN	
1.18	1.18 x .12	3611	.94	2.28	4.02	1.75	.91	1.81	1.97	146.04	FI-ASV-30Sx5-B-W159-MSN	
30	30 x 4	323	22	58	102	44,5	23	46	50	71,62	FI-ASV-30Sx5.5-B-W159-MSN	
1.18	1.18 x .16	4684	.87	2.28	4.02	1.75	.91	1.81	1.97	157.56	FI-ASV-30Sx6-B-W159-MSN	
30	30 x 5	393	20	58	102	44,5	23	46	50	75,33	FI-ASV-30Sx6.5-B-W159-MSN	
1.18	1.18 x .20	5699	.79	2.28	4.02	1.75	.91	1.81	1.97	165.73	FI-ASV-38Sx4-B-W159-MSN	
30	30 x 6	400	18	58	102	44,5	23	46	50	79,03	FI-ASV-38Sx4.5-B-W159-MSN	
1.18	1.18 x .24	5800	.71	2.28	4.02	1.75	.91	1.81	1.97	173.87	FI-ASV-38Sx5-B-W159-MSN	
38	38 x 4	261	30	60	109	44	22	55	60	102,93	FI-ASV-38Sx5.5-B-W159-MSN	
1.50	1.50 x .16	3785	1.18	2.36	4.29	1.73	.87	2.17	2.36	226.45	FI-ASV-38Sx6-B-W159-MSN	
38	38 x 5	315	28	60	109	44	22	55	60	108,61	FI-ASV-38Sx6.5-B-W159-MSN	
1.50	1.50 x .20	4568	1.10	2.36	4.29	1.73	.87	2.17	2.36	238.94	FI-ASV-38Sx7-B-W159-MSN	
38	38 x 6	315	26	60	109	44	22	55	60	114,48	FI-ASV-38Sx7.5-B-W159-MSN	
1.50	1.50 x .24	4568	1.02	2.36	4.29	1.73	.87	2.17	2.36	251.86	FI-ASV-38Sx8-B-W159-MSN	
38	38 x 7	315	24	60	109	44	22	55	60	119,83	FI-ASV-38Sx8.5-B-W159-MSN	
1.50	1.50 x .28	4568	.94	2.36	4.29	1.73	.87	2.17	2.36	263.63		

¹ Approximate dimension in assembled condition.

² Weight including 24° weld cone and union nut.

³ Standard scope of delivery:

24° weld cone, O-ring and union nut.

Standard seal material is NBR (Buna-N®).



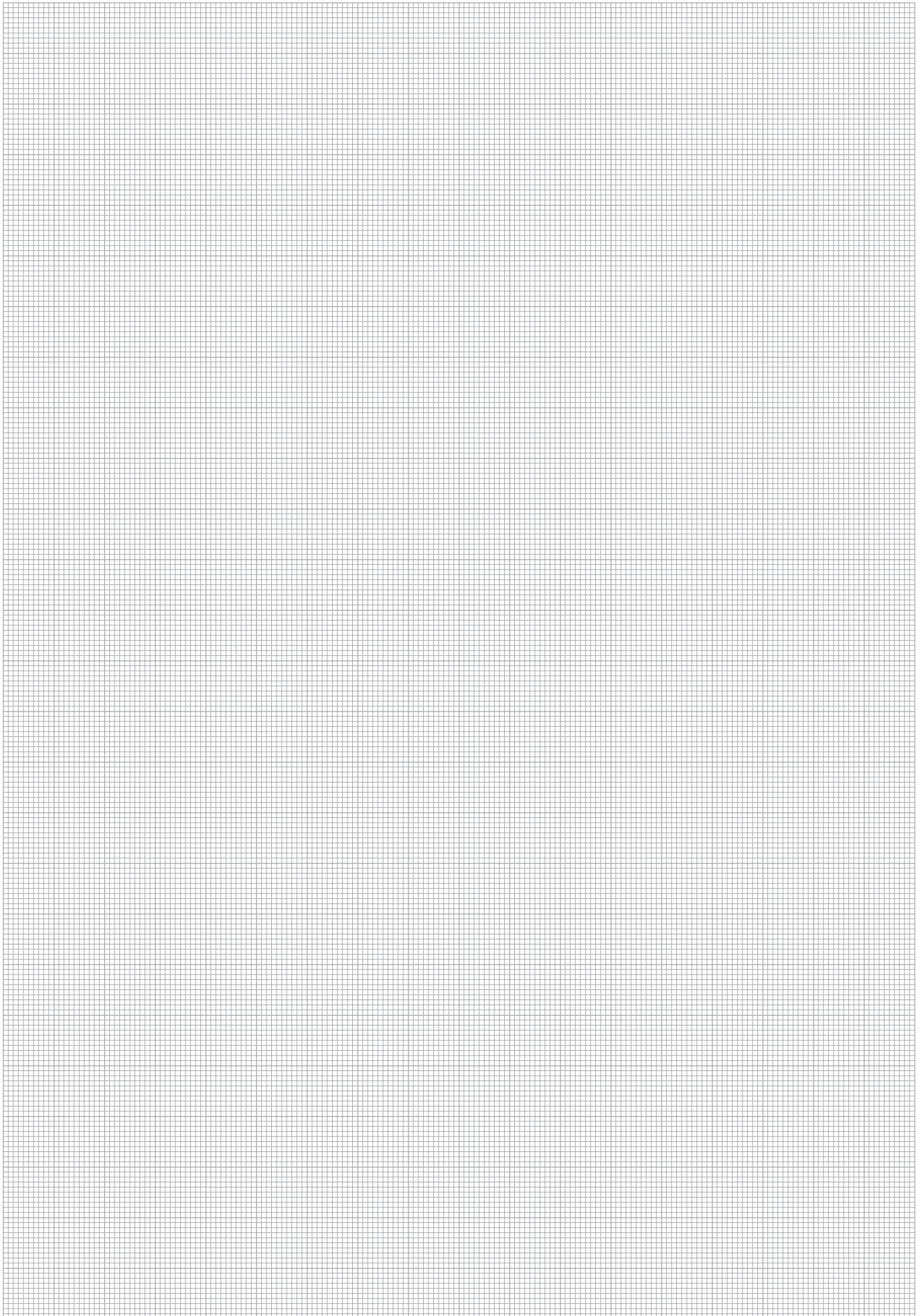







F





	Straight Female Stud Fitting	108-110
	FI-GA	
	Female Whitworth Parallel Pipe Thread (BSPP)	108
	FI-GA-...-R	
	Female Metric Parallel Thread	109
	FI-GA-...-M	
	Female NPT Thread	110
	FI-GA-...-N	
	Gauge Fitting	111
	FI-MA	
	Female Whitworth Parallel Pipe Thread (BSPP) / Internal Metallic Sealing Ring	111
	FI-MA-...-R	
	Gauge Fitting with 24° Taper / O-Ring	112
	FI-EMAD	
	Female Whitworth Parallel Pipe Thread (BSPP) / Internal Metallic Sealing Ring	112
	FI-EMAD-...-R	
	Gauge Standpipe Fitting	113
	FI-EMA	
	Female Whitworth Parallel Pipe Thread (BSPP) / Internal Metallic Sealing Ring	113
	FI-EMA-...-R	



Straight Female Stud Fitting
Type FI-GA-...-R ■ Series L / S

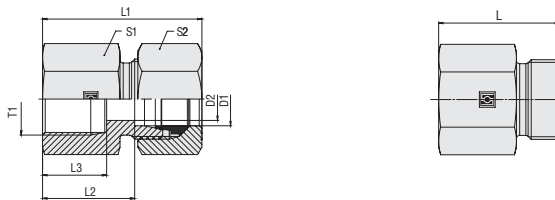

Female Whitworth Parallel Pipe Thread (BSPP)

Ordering Codes

***FI-GA*-10*L*R*-W3*-MS**

- * Straight Female Stud Fitting **FI-GA**
- * Outside Tube Diameter D1 (in mm) **-10**
- * Series **L**
Light Series
Heavy Series **S**
- * Thread Type **R**
Female Whitworth Parallel Pipe Thread (BSPP)
- If required, please indicate special sizes, e.g. R3/8!
- * Material Code **-W3**
Steel, zinc/nickel-plated
- Please contact STAUFF for alternative materials and surface finishings.
- * Assembling / Kitting **—**
Fitting body only
- MS**
Fitting body supplied with cutting ring and union nut
- MSV**
Fitting body supplied with soft-sealing cutting ring and union nut

Connecting Parts

- Cutting Ring Type **FI-DS** Page 26
- Soft-Sealing Cutting Ring Type **FI-WDDS** Page 27
- Support Sleeve Type **FI-VH** Page 28
- STAUFF Form Ring Type **FI-AR** Page 30
- Union Nut Type **FI-M** Page 31
- 37° Flared Tube Fitting Set Type **FI-AB** Page 35

Series	Tube OD		PN	Dimensions								Weight (^{kg} /lbs) ca. per 100 ²	Ordering Codes ³
	(mm/in)	(mm/in)		(mm/in)	Thread	T	D2	L	L1 ¹	L2	L3		
L	6	315	G 1/8	4	26	34	19	12	14	14	3,26	FI-GA-06LR-W3	
	.24	4568		.16	1.02	1.34	.75	.47	.55	.55	7.16		
	6	315	G 1/4	4	31	39	24	18	19	14	3,78	FI-GA-06LR1/4-W3	
	.24	4568		.16	1.22	1.54	.94	.71	.75	.55	8.32		
	8	315	G 1/4	6	31	39	24	17	19	17	3,91	FI-GA-08LR-W3	
	.31	4568		.24	1.22	1.54	.94	.67	.75	.67	8.61		
	8	315	G 3/8	6	31	39	24	16	24	17	2,28	FI-GA-08LR3/8-W3	
	.31	4568		.24	1.22	1.54	.94	.63	.94	.67	5.02		
	8	315	G 1/2	6	36	44	29	20	27	17	8,35	FI-GA-08LR1/2-W3	
	.31	4568		.24	1.42	1.73	1.14	.79	1.06	.67	18.37		
	10	315	G 1/4	8	32	40	25	17	19	19	3,95	FI-GA-10LR-W3	
	.39	4568		.31	1.26	1.57	.98	.67	.75	.75	8.69		
	10	315	G 3/8	8	32	40	25	16	24	19	4,94	FI-GA-10LR3/8-W3	
	.39	4568		.31	1.26	1.57	.98	.63	.94	.75	10.86		
	10	315	G 1/2	8	37	45	30	20	27	19	8,36	FI-GA-10LR1/2-W3	
	.39	4568		.31	1.46	1.77	1.18	.79	1.06	.75	18.39		
	12	315	G 1/4	8	33	41	26	17	19	22	4,44	FI-GA-12LR1/4-W3	
	.47	4568		.31	1.3	1.61	1.02	.67	.75	.87	9.76		
	12	315	G 3/8	10	33	41	26	17	24	22	6,43	FI-GA-12LR-W3	
	.47	4568		.39	1.3	1.61	1.02	.67	.94	.87	14.14		
	12	315	G 1/2	10	37	45	30	20	27	22	8,38	FI-GA-12LR1/2-W3	
	.47	4568		.39	1.46	1.77	1.18	.79	1.06	.87	18.44		
	15	315	G 1/2	12	38	46	31	20	27	27	8,84	FI-GA-15LR-W3	
	.59	4568		.47	1.50	1.81	1.22	.79	1.06	1.06	19.46		
	18	315	G 3/8	15	34	43	26,5	20	27	32	9,61	FI-GA-18LR3/8-W3	
	.71	4568		.59	1.34	1.69	1.04	.79	1.06	1.26	21.15		
	18	315	G 1/2	15	38	47	30,5	20	27	32	9,15	FI-GA-18LR-W3	
	.71	4568		.59	1.50	1.85	1.20	.79	1.06	1.26	20.14		
	22	160	G 3/4	19	43	52	35,5	22	36	36	17,87	FI-GA-22LR-W3	
	.87	2320		.75	1.69	2.05	1.40	.87	1.42	1.42	39.31		
28	160	G 1	24	45,5	54,5	38	24,5	41	41	21,80	FI-GA-28LR-W3		
1.1	2320		.94	1.79	2.15	1.50	.96	1.61	1.61	47.96			
35	160	G 1 1/4	30	51,5	62,5	41	26,5	55	50	47,49	FI-GA-35LR-W3		
1.38	2320		1.18	2.03	2.46	1.61	1.04	2.17	1.97	104.47			
42	160	G 1 1/2	36	53,5	65,5	42,5	28,5	60	60	53,90	FI-GA-42LR-W3		
1.65	2320		1.42	2.11	2.58	1.67	1.12	2.36	2.36	118.58			
S	6	630	G 1/4	4	33	41	26	17	19	17	4,33	FI-GA-06SR-W3	
	.24	9135		.16	1.3	1.61	1.02	.67	.75	.67	9.52		
	8	630	G 1/4	5	33	41	26	17	19	19	4,53	FI-GA-08SR-W3	
	.31	9135		.2	1.30	1.61	1.02	.67	.75	.75	9.96		
	10	630	G 3/8	7	34	43	26,5	17	24	22	6,99	FI-GA-10SR-W3	
	.39	9135		.28	1.34	1.69	1.04	.67	.94	.87	15.37		
	12	630	G 3/8	8	34	43	26,5	17	24	24	7,08	FI-GA-12SR-W3	
	.47	9135		.31	1.34	1.69	1.04	.67	.94	.94	15.57		
	12	630	G 1/2	8	38	47	30,5	20	27	24	9,23	FI-GA-12SR1/2-W3	
	.47	9135		.31	1.50	1.85	1.20	.79	1.06	.94	20.31		
	14	630	G 1/2	10	40	50	32	20	27	27	9,64	FI-GA-14SR-W3	
	.55	9135		.39	1.57	1.97	1.26	.79	1.06	1.06	21.20		
	16	630	G 1/2	12	40	50	31,5	20	27	30	9,70	FI-GA-16SR-W3	
	.63	9135		.47	1.57	1.97	1.24	.79	1.06	1.18	21.33		
	20	400	G 3/4	16	45	56	34,5	22	36	36	19,50	FI-GA-20SR-W3	
	.79	5800		.63	1.77	2.20	1.36	.87	1.42	1.42	42.90		
	25	400	G 1	20	49,5	61,5	37,5	24,5	41	46	25,14	FI-GA-25SR-W3	
	.98	5800		.79	1.95	2.42	1.48	.96	1.61	1.81	55.30		
	30	400	G 1 1/4	25	55,5	68,5	42	26,5	55	50	51,30	FI-GA-30SR-W3	
	1.18	5800		.98	2.19	2.70	1.65	1.04	2.17	1.97	112.86		
	38	315	G 1 1/2	32	59,5	74,5	43,5	28,5	60	60	62,80	FI-GA-38SR-W3	
	1.50	4568		1.26	2.34	2.93	1.71	1.12	2.36	2.36	138.16		

¹ Approximate dimension in assembled condition.

² Weight excluding cutting ring and union nut.

³ Standard scope of delivery: Fitting body only.



Straight Female Stud Fitting
Type FI-GA...-M • Series L / S

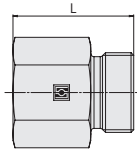
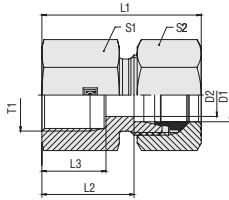

Female Metric Parallel Thread

Series	Tube OD (mm/in)	PN (bar/PSI)	Dimensions (mm/in)								Weight (kg/lbs) ca. per 100 ²	Ordering Codes ³
			Thread	T	D2	L	L1 ¹	L2	L3	S1		
L	6	315	M10 x 1	4	26,5	34,5	19,5	12,5	14	14	1,89	FI-GA-06LM-W3
	.24	4568		.16	1.04	1.36	.77	.49	.55	.55	4.15	
	8	315	M12 x 1,5	6	31	39	24	17	17	17	3,40	FI-GA-08LM-W3
	.31	4568		.24	1.22	1.54	.94	.67	.67	.67	7.48	
	10	315	M14 x 1,5	8	32	40	25	17	19	19	3,73	FI-GA-10LM-W3
	.39	4568		.31	1.26	1.57	.98	.67	.75	.75	8.20	
	12	315	M16 x 1,5	10	33	41	26	17	22	22	5,29	FI-GA-12LM-W3
	.47	4568		.39	1.30	1.61	1.02	.67	.87	.87	11.64	
	15	315	M18 x 1,5	12	35	43	28	17	24	27	6,77	FI-GA-15LM-W3
	.59	4568		.47	1.38	1.69	1.10	.67	.94	1.06	14.89	
	18	315	M22 x 1,5	15	37	46	29,5	19	30	32	11,20	FI-GA-18LM-W3
	.71	4568		.59	1.46	1.81	1.16	.75	1.18	1.26	24.63	
	22	160	M26 x 1,5	19	42	51	34,5	21	32	36	12,42	FI-GA-22LM-W3
	.87	2320		.75	1.65	2.01	1.36	.83	1.26	1.42	27.33	
	28	160	M33 x 2	24	45	54	37,5	24	41	41	21,35	FI-GA-28LM-W3
	1.10	2320		.94	1.77	2.13	1.48	.94	1.61	1.61	46.97	
35	160	M42 x 2	30	51	62	40,5	26	55	50	46,20	FI-GA-35LM-W3	
1.38	2320		1.18	2.01	2.44	1.59	1.02	2.17	1.97	101.64		
42	160	M48 x 2	36	53	65	42	28	60	60	52,10	FI-GA-42LM-W3	
1.65	2320		1.42	2.09	2.56	1.65	1.10	2.36	2.36	114.62		
S	8	630	M14 x 1,5	5	33	41	26	17	19	19	4,36	FI-GA-08SM-W3
	.31	9135		.20	1.30	1.61	1.02	.67	.75	.75	9.59	
	10	630	M16 x 1,5	7	34	43	26,5	17	22	22	1,31	FI-GA-10SM-W3
	.39	9135		.28	1.34	1.69	1.04	.67	.87	.87	2.89	
	12	630	M18 x 1,5	8	35	44	27,5	17	24	24	7,01	FI-GA-12SM-W3
	.47	9135		.31	1.38	1.73	1.08	.67	.94	.94	15.41	
	14	630	M20 x 1,5	10	39	49	31	19	27	27	9,54	FI-GA-14SM-W3
	.55	9135		.39	1.54	1.93	1.22	.75	1.06	1.06	20.99	
	16	630	M22 x 1,5	12	39	49	30,5	19	30	30	11,71	FI-GA-16SM-W3
	.63	9135		.47	1.54	1.93	1.20	.75	1.18	1.18	25.76	
	20	400	M27 x 2	16	45	56	34,5	22	36	36	18,68	FI-GA-20SM-W3
	.79	5800		.63	1.77	2.20	1.36	.87	1.42	1.42	41.09	
	25	400	M33 x 2	20	49	61	37	24	41	46	24,73	FI-GA-25SM-W3
	.98	5800		.79	1.93	2.40	1.46	.94	1.61	1.81	54.40	
	30	400	M42 x 2	25	55	68	41,5	26	55	50	50,30	FI-GA-30SM-W3
	1.18	5800		.98	2.17	2.68	1.63	1.02	2.17	1.97	110.66	
38	400	M48 x 2	32	59	74	43	28	60	60	62,80	FI-GA-38SM-W3	
1.50	5800		1.26	2.32	2.91	1.69	1.10	2.36	2.36	138.16		

¹ Approximate dimension in assembled condition.

² Weight excluding cutting ring and union nut.

³ Standard scope of delivery: Fitting body only.

Ordering Codes

***FI-GA*-10*L*M*-W3*-MS**

* Straight Female Stud Fitting	FI-GA
* Outside Tube Diameter D1 (in mm)	-10
* Series	Light Series L Heavy Series S
* Thread Type	Female Metric Parallel Thread M
If required, please indicate special sizes, e.g. M12x1.5!	
* Material Code	Steel, zinc/nickel-plated -W3
Please contact STAUFF for alternative materials and surface finishings.	
* Assembling / Kitting	Fitting body only —
	Fitting body supplied with cutting ring and union nut -MS
	Fitting body supplied with soft-sealing cutting ring and union nut -MSV

Connecting Parts

	Cutting Ring Type FI-DS	Page 26
	Soft-Sealing Cutting Ring Type FI-WDDS	Page 27
	Support Sleeve Type FI-VH	Page 28
	STAUFF Form Ring Type FI-AR	Page 30
	Union Nut Type FI-M	Page 31
	37° Flared Tube Fitting Set Type FI-AB	Page 35



Straight Female Stud Fitting
Type FI-GA-...-N ■ Series L / S

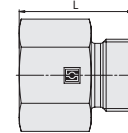
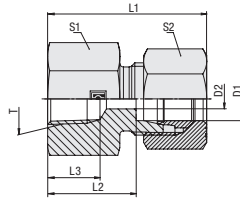

NPT Thread

Ordering Codes

***FI-GA*-10*L*1/4*N*-W3*-MS**

- * Straight Female Stud Fitting **FI-GA**
- * Outside Tube Diameter D1 (in mm) **-10**
- * Series **L**
Light Series
Heavy Series **S**
- * Thread Size **1/4**
acc. to dimension table
- Please always indicate thread sizes, e.g. 1/4!
- * Thread Type **N**
NPT Thread
- * Material Code **-W3**
Steel, zinc/nickel-plated
- Please contact STAUFF for alternative materials and surface finishings.
- * Assembling / Kitting **—**
Fitting body only
- Fitting body supplied with cutting ring and union nut **-MS**
- Fitting body supplied with soft-sealing cutting ring and union nut **-MSV**

Series	Tube OD (mm/in)	PN (bar/psi)	Dimensions (mm/in)									Weight (kg/lbs) ca. per 100 ²	Ordering Codes ³
			Thread	T	D2	L	L1 ¹	L2	L3	S1	S2		
L	6	315	1/4 NPT	4	30,5	38	23,5	16,4	19	14	4,20	FI-GA-06L1/4N-W3	
	.24	4568		.16	1.20	1.50	.93	.65	.75	.55	9.24		
	8	315	1/4 NPT	6	30,5	38	23,5	16,4	19	17	4,30	FI-GA-08L1/4N-W3	
	.31	4568		.24	1.20	1.50	.93	.65	.75	.67	9.46		
	10	315	1/4 NPT	8	31	39	24,0	16,4	19	19	4,10	FI-GA-10L1/4N-W3	
	.39	4568		.31	1.22	1.54	.95	.65	.75	.75	9.02		
S	16	400	1/2 NPT	12	43	50	34,5	22,6	27	30	11,70	FI-GA-16S1/2N-W3	
	.63	5800		.47	1.69	1.97	1.36	.89	1.06	1.18	25.74		
	20	315	1/2 NPT	16	44	55	33,5	23,1	32	36	16,00	FI-GA-20S1/2N-W3	
	.79	4568		.63	1.73	2.17	1.32	.91	1.26	1.42	35.20		
	20	315	3/4 NPT	16	46	57	35,5	23,1	36	36	20,29	FI-GA-20S3/4N-W3	
	.79	4568		.63	1.81	2.24	1.40	.91	1.42	1.42	44.63		

¹ Approximate dimension in assembled condition.

² Weight excluding cutting ring and union nut.

³ Standard scope of delivery: Fitting body only.

Connecting Parts

- Cutting Ring
Type **FI-DS** Page 26
- Soft-Sealing Cutting Ring
Type **FI-WDDS** Page 27
- Support Sleeve
Type **FI-VH** Page 28
- STAUFF Form Ring
Type **FI-AR** Page 30
- Union Nut
Type **FI-M** Page 31
- 37° Flared Tube Fitting Set
Type **FI-AB** Page 35

G



Gauge Fitting
Type FI-MA-...-R • Series L / S

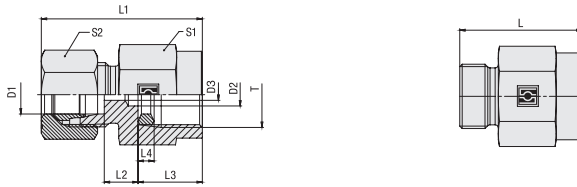

Internal Metallic Sealing Ring

Female Whitworth Parallel Pipe Thread (BSPP)

Series	Tube OD (mm/in)	PN (bar/PSI)	Dimensions (mm/in)	Dimensions										Weight (kg/lbs) ca. per 100 ²	Ordering Codes ³
				Thread	T	D2	D3	L	L1 ¹	L2	L3	L4	S1		
L	6	315	G 1/4	5,5	4	29	37	7,5	14,5	4,5	19	14	3,76	FI-MA-06LR-W3-DKI	
	.24	4568		.22	.16	1.14	1.46	.30	.57	.18	.75	.55	8.27		
	8	315	G 1/4	5,5	5,5	29	37	7,5	14,5	4,5	19	17	3,74	FI-MA-08LR-W3-DKI	
	.31	4568		.22	.22	1.14	1.46	.30	.57	.18	.75	.67	8.23		
	10	315	G 1/4	5,5	5,5	30	38	8,5	14,5	4,5	19	19	4,05	FI-MA-10LR-W3-DKI	
	.39	4568		.22	.22	1.18	1.50	.33	.57	.18	.75	.75	8.92		
12	315	G 1/4	5,5	5,5	30	38	8,5	14,5	4,5	19	22	4,31	FI-MA-12LR-W3-DKI		
.47	4568		.22	.22	1.18	1.50	.33	.57	.18	.75	.87	9.48			
S	6	630	G 1/2	7	4	38	46	11	20	5	27	17	9,16	FI-MA-06SR-W3-DKI	
	.24	9135		.28	.16	1.50	1.81	.43	.79	.20	1.06	.67	2.16		
	8	630	G 1/2	7	5	38	46	11	20	5	27	19	9,30	FI-MA-08SR-W3-DKI	
	.31	9135		.28	.20	1.50	1.81	.43	.79	.20	1.06	.75	2.46		
	10	630	G 1/2	7	3,5	38	47	10,5	20	5	27	22	9,39	FI-MA-10SR-W3-DKI	
	.39	9135		.28	.14	1.50	1.85	.41	.79	.20	1.06	.87	2.65		
12	630	G 1/2	7	3,5	38	47	10,5	20	5	27	24	9,76	FI-MA-12SR-W3-DKI		
.47	9135		.28	.14	1.50	1.85	.41	.79	.20	1.06	.94	21.47			

¹ Approximate dimension in assembled condition.
² Weight excluding cutting ring and union nut.
³ Standard scope of delivery: Fitting body only.

Ordering Codes

FI-MA-10*L*R*-W3*-DKI

- * Gauge Fitting FI-MA
- * Outside Tube Diameter D1 (in mm) -10
- * Series Light Series L
Heavy Series S
- * Thread Type Female Whitworth Parallel Pipe Thread (BSPP) R
- If required, please indicate special sizes, e.g. R1/2!
- * Material Code Steel, zinc/nickel-plated -W3
- Please contact STAUFF for alternative materials and surface finishings.
- * Internal Seal Type Internal metallic sealing ring -DKI
- * Assembling / Kitting Fitting body only —
Fitting body supplied with cutting ring and union nut -MS
Fitting body supplied with soft-sealing cutting ring and union nut -MSV

Connecting Parts

-  Cutting Ring
Type FI-DS Page 26
-  Soft-Sealing Cutting Ring
Type FI-WDDS Page 27
-  Support Sleeve
Type FI-VH Page 28
-  STAUFF Form Ring
Type FI-AR Page 30
-  Union Nut
Type FI-M Page 31
-  37° Flared Tube Fitting Set
Type FI-AB Page 35

Spare Parts / Accessories

-  Internal Metallic Sealing Ring
Type FI-DKI Page 214



Gauge Fitting with 24° Taper / O-Ring
Type FI-EMAD-...-R ▪ Series L / S

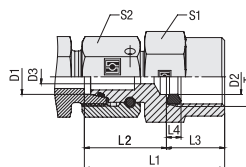

Female Whitworth Parallel Pipe Thread (BSPP)

Internal Metallic Sealing Ring

Ordering Codes

***FI-EMAD*-10*L*R*-W3*-DKI-DKO**

- * Gauge Fitting with 24° Taper / O-Ring **FI-EMAD**
- * Outside Tube Diameter D1 (in mm) **-10**
- * Series Light Series **L**
Heavy Series **S**
- * Thread Type Female Whitworth Parallel Pipe Thread (BSPP) **R**
- If required, please indicate special sizes, e.g. R1/2!
- * Seal Material NBR (Buna-N®) **-B**
FKM (Viton®) **-V**
EPDM **-E**
- * Material Code Steel, zinc/nickel-plated **-W3**
- Please contact STAUFF for alternative materials and surface finishings.
- * Internal Seal Type Internal metallic sealing ring **-DKI**
- * Assembling / Kitting Fitting body supplied with swivel nut and O-ring **-DKO**

Series	Tube OD (mm/in) D1	PN (bar/psi)	Dimensions (mm/in)										Weight (kg/lbs) ca. per 100	Ordering Codes
			Thread	T	D2	D3	L1	L2	L3	L4	S1	S2		
L	6	315	G 1/4	5,5	3	38,5	24	14,5	4,5	19	14	6,34	FI-EMAD-06LR-B-W3-DKI-DKO	
	.24	4568		.22	.12	1.52	.94	.57	.18	.75	.55	13.95		
	8	315	G 1/4	5,5	3	38,5	24	14,5	4,5	19	17	6,16	FI-EMAD-08LR-B-W3-DKI-DKO	
	.31	4568		.22	.14	1.52	.94	.57	.18	.75	.67	13.56		
	10	315	G 1/4	5,5	3,5	39,5	25	14,5	4,5	19	19	7,22	FI-EMAD-10LR-B-W3-DKI-DKO	
	.39	4568		.22	.14	1.56	.98	.57	.18	.75	.75	15.88		
	12	315	G 1/4	5,5	3,5	36	21,5	14,5	4,5	19	22	8,48	FI-EMAD-12LR-B-W3-DKI-DKO	
.47	4568		.22	.14	1.42	.85	.57	.18	.75	.87	18.66			
S	6	630	G 1/4	5,5	3,0	38	23,5	14,5	4,5	19	17	6,08	FI-EMAD-06SR1/4-B-W3-DKI-DKO	
	.24	9135		.22	.12	1.50	.93	.57	.18	.75	.67	13.38		
	6	630	G 1/2	7	3	45	25	20	5	27	17	11,49	FI-EMAD-06SR-B-W3-DKI-DKO	
	.24	9135		.28	.12	1.77	.98	.79	.20	1.06	.67	25.29		
	8	630	G 1/4	5,5	3,5	40	25,5	14,5	4,5	19	19	6,55	FI-EMAD-08SR1/4-B-W3-DKI-DKO	
	.31	9135		.22	.14	1.57	1.00	.57	.18	.75	.75	14.41		
	8	630	G 1/2	7	3,5	42,5	22,5	20	5	27	19	10,87	FI-EMAD-08SR-B-W3-DKI-DKO	
	.31	9135		.28	.14	1.67	.89	.79	.20	1.06	.75	23.92		
	10	630	G 1/4	5,5	3,5	38,5	24	14,5	4,5	19	22	7,66	FI-EMAD-10SR1/4-B-W3-DKI-DKO	
	.39	9135		.22	.14	1.52	.94	.57	.18	.75	.87	16.86		
	10	630	G 1/2	7	3,5	43,5	23,5	20	5	27	22	12,19	FI-EMAD-10SR-B-W3-DKI-DKO	
	.39	9135		.28	.14	1.71	.93	.79	.20	1.06	.87	26.83		
	12	630	G 1/4	5,5	3,5	40	25,5	14,5	4,5	19	24	9,40	FI-EMAD-12SR1/4-B-W3-DKI-DKO	
	.47	9135		.22	.14	1.57	1.00	.57	.18	.75	.94	20.69		
12	630	G 1/2	7	3,5	45,5	25,5	20	5	27	24	13,98	FI-EMAD-12SR-B-W3-DKI-DKO		
.47	9135		.28	.14	1.79	1.00	.79	.20	1.06	.94	30.76			

Standard seal material is NBR (Buna-N®).

Spare Parts / Accessories



O-Ring
Type **O-RING** Page 207



Internal Metallic Sealing Ring
Type **FI-DKI** Page 214

G



Gauge Standpipe Fitting
Type FI-EMA-...-R ▪ Series L / S

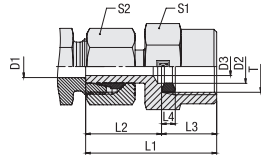

Internal Metallic Sealing Ring

Female Whitworth Parallel Pipe Thread (BSPP)

Series	Tube OD		Dimensions (mm/in)	Dimensions										Weight (kg/lbs) Ca. per 100 ¹	Ordering Codes
	(mm/in)	PN (bar/PSI)		Thread T	D2	D3	L1	L2	L3	L4	S1	S2			
L	6	315	G 1/4	5,5	3,3	38	23,5	14,5	4,5	19	14	4,65	FI-EMA-06LR-W3-DKI-SV		
	.24	4568		.22	.13	1.5	.93	.57	.18	.75	.55	10.23			
	8	315	G 1/4	5,5	3,5	38	23,5	14,5	4,5	19	17	5,53	FI-EMA-08LR-W3-DKI-SV		
	.31	4568		.22	.14	1.5	.93	.57	.18	.75	.67	12.16			
	10	315	G 1/4	5,5	3,5	39,5	25	14,5	4,5	19	19	6,40	FI-EMA-10LR-W3-DKI-SV		
	.39	4568		.22	.14	1.56	.98	.57	.18	.75	.75	14.08			
12	315	G 1/4	5,5	3,5	40,5	26	14,5	4,5	19	22	8,01	FI-EMA-12LR-W3-DKI-SV			
.47	4568		.22	.14	1.59	1.02	.57	.18	.75	.87	17.63				
S	6	630	G 1/2	7	3,5	45	25	20	5	27	17	10,73	FI-EMA-06SR-W3-DKI-SV		
	.24	9135		.28	.14	1.77	.98	.79	.2	1.06	.67	23.61			
	8	630	G 1/2	7	3,5	45	25	20	5	27	19	10,95	FI-EMA-08SR-W3-DKI-SV		
	.31	9135		.28	.14	1.77	.98	.79	.2	1.06	.75	24.09			
	10	630	G 1/2	7	3,5	47	27	20	5	27	22	12,15	FI-EMA-10SR-W3-DKI-SV		
	.39	9135		.28	.14	1.85	1.06	.79	.2	1.06	.87	26.73			
12	630	G 1/2	7	3,5	47,5	27,5	20	5	27	24	13,43	FI-EMA-12SR-W3-DKI-SV			
.47	9135		.28	.14	1.87	1.08	.79	.2	1.06	.94	29.55				

¹ Weight including cutting ring and union nut.

Please note: Standpipes are always factory-assembled with cutting rings and union nuts.

The union nut assembled on the standpipe has to be tightened by only 1/12 a turn (equivalent to 30°) beyond the fixed point.



Ordering Codes

***FI-EMA*-10*L*R*-W3*-DKI-SV**

- * Gauge Standpipe Fitting FI-EMA
- * Outside Tube Diameter D1 (in mm) -10
- * Series Light Series L
Heavy Series S
- * Thread Type Female Whitworth Parallel Pipe Thread (BSPP) R
- If required, please indicate special sizes, e.g. R1/2!
- * Material Code Steel, zinc/nickel-plated -W3
- Please contact STAUFF for alternative materials and surface finishings.
- * Internal Seal Type Internal metallic sealing ring -DKI
- * Assembling / Kitting Standpipe factory-assembled with cutting ring and union nut -SV

Spare Parts / Accessories





Internal Metallic Sealing Ring
Type FI-DKI Page 214

G





	Straight Male Stud Fitting with 24° Taper / O-Ring	116-117
	FI-EGED	
	Whitworth Parallel Pipe Thread (BSPP) / Profile Sealing Ring	116
	FI-EGED-...-R-WD	
	Metric Parallel Thread / Profile Sealing Ring	117
	FI-EGED-...-M-WD	
	Straight Fitting with 24° Taper / O-Ring	118
	FI-SNV	
	Straight Reducer with 24° Taper / O-Ring	120
	FI-SNV	
	Straight Reducer for Tube Ends with 24° Taper / O-Ring	122
	FI-RESD	
	Adjustable Elbow (90°) with 24° Taper / O-Ring	126
	FI-EWD	
	Adjustable Elbow (45°) with 24° Taper / O-Ring	127
	FI-EVD	
	Adjustable Branch Tee with 24° Taper / O-Ring	128
	FI-ETD	
	Adjustable Barrel Tee with 24° Taper / O-Ring	129
	FI-ELD	



Straight Male Stud Fitting with 24° Taper / O-Ring
Type FI-EGED-...-R-WD ▪ Series L / S

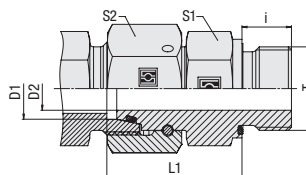

Whitworth Parallel Pipe Thread (BSPP)

Profile Sealing Ring

Ordering Codes

***FI-EGED*-10*L*R*-WD*-B*-W3*-DKO**

* Straight Male Stud Fitting with 24° Taper / O-Ring (DKO) **FI-EGED**

* Outside Tube Diameter D1 (in mm) **-10**

* Series Light Series **L**
 Heavy Series **S**

* Thread Type Whitworth Parallel Pipe Thread (BSPP) **R**

If required, please indicate special sizes, e.g. R3/8!

* Seal Type Profile Sealing Ring **-WD**

* Seal Material NBR (Buna-N®) **-B**
 FKM (Viton®) **-V**

* Material Code Male Stud: NBR (Buna-N®) **-BV**
 24° Taper: FKM (Viton®) **-E**
 EPDM **-E**

* Material Code Steel, zinc/nickel-plated **-W3**

Please contact STAUFF for alternative materials and surface finishings.

* Assembling / Kitting Fitting body supplied with swivel nut and O-ring **-DKO**

Spare Parts / Accessories



O-Ring
 Type **O-RING** Page 207



Profile Sealing Ring
 Type **WDG** Page 206

Series	Tube OD		PN	Dimensions						Torque (N·m/ft·lb)	Weight (% / lbs) ca. per 100	Ordering Codes
	(mm/in)	(mm/in)		Thread	T	D2	i	L1	S1			
L	6	500	G 1/8	2,5	8	24,5	14	14	18	3,74	FI-EGED-06LR-WD-B-W3-DKO	
	.24	7250		.10	.31	.96	.55	.55	13.3	8.22		
	8	500	G 1/4	4	12	29,5	19	17	35	5,23	FI-EGED-08LR-WD-B-W3-DKO	
	.31	7250		.16	.47	1.16	.75	.67	25.9	11.50		
	10	500	G 1/4	6	12	27,5	19	19	35	5,68	FI-EGED-10LR-WD-B-W3-DKO	
	.39	7250		.24	.47	1.08	.75	.75	25.9	12.49		
	12	400	G 3/8	8	12	34	22	22	70	9,78	FI-EGED-12LR-WD-B-W3-DKO	
	.47	5800		.31	.47	1.34	.87	.87	51.8	21.52		
	12	400	G 1/2	8	14	29,5	27	22	90	11,71	FI-EGED-12LR1/2-WD-B-W3-DKO	
	.47	5800		.31	.55	1.16	1.06	.87	66.6	25.76		
	15	400	G 1/2	10	14	32	27	27	90	13,70	FI-EGED-15LR-WD-B-W3-DKO	
	.59	5800		.39	.55	1.26	1.06	1.06	66.6	30.14		
	18	400	G 1/2	13	14	31,5	27	32	90	14,86	FI-EGED-18LR-WD-B-W3-DKO	
	.71	5800		.51	.55	1.24	1.06	1.26	66.6	32.69		
	22	250	G 3/4	17	16	32,5	32	36	180	20,98	FI-EGED-22LR-WD-B-W3-DKO	
	.87	3625		.67	.63	1.28	1.26	1.42	133.2	46.15		
	28	250	G 1	22	18	35	41	41	310	22,78	FI-EGED-28LR-WD-B-W3-DKO	
	1.10	3625		.87	.71	1.38	1.61	1.61	229.4	50.12		
35	250	G 1 1/4	28	20	42,5	50	50	450	51,00	FI-EGED-35LR-WD-B-W3-DKO		
1.38	3625		1.10	.79	1.67	1.97	1.97	333.0	112.20			
42	250	G 1 1/2	34	22	46,5	55	60	540	68,60	FI-EGED-42LR-WD-B-W3-DKO		
1.65	3625		1.34	.87	1.83	2.17	2.36	399.6	150.92			
S	6	800	G 1/4	2,5	12	27	19	17	55	5,55	FI-EGED-06SR-WD-B-W3-DKO	
	.24	11600		.10	.47	1.06	.75	.67	40.7	12.21		
	8	800	G 1/4	4	12	29,5	19	19	55	6,52	FI-EGED-08SR-WD-B-W3-DKO	
	.31	11600		.16	.47	1.16	.75	.75	40.7	14.34		
	10	800	G 3/8	6	12	32	22	22	80	9,63	FI-EGED-10SR-WD-B-W3-DKO	
	.39	11600		.24	.47	1.26	.87	.87	59.2	21.19		
	12	630	G 3/8	8	12	34	22	24	80	7,03	FI-EGED-12SR-WD-B-W3-DKO	
	.47	9135		.31	.47	1.34	.87	.94	59.2	15.46		
	14	630	G 1/2	9	14	37	27	27	115	14,39	FI-EGED-14SR-WD-B-W3-DKO	
	.55	9135		.35	.55	1.46	1.06	1.06	85.1	31.67		
	16	630	G 1/2	11	14	37	27	30	115	17,03	FI-EGED-16SR-WD-B-W3-DKO	
	.63	9135		.43	.55	1.46	1.06	1.18	85.1	37.46		
	20	400	G 3/4	14	16	43	32	36	180	27,34	FI-EGED-20SR-WD-B-W3-DKO	
	.79	5800		.55	.63	1.69	1.26	1.42	133.2	60.15		
	25	400	G 1	18	18	48	41	46	310	50,20	FI-EGED-25SR-WD-B-W3-DKO	
.98	5800		.71	.71	1.89	1.61	1.81	229.4	110.44			
30	400	G 1 1/4	23	20	51	50	50	450	70,40	FI-EGED-30SR-WD-B-W3-DKO		
1.18	5800		.91	.79	2.01	1.97	1.97	333.0	154.88			
38	400	G 1 1/2	30	22	60	55	60	540	93,50	FI-EGED-38SR-WD-B-W3-DKO		
1.50	5800		1.18	.87	2.36	2.17	2.36	399.6	205.70			

Standard seal material is NBR (Buna-N®).

Male stud acc. to ISO 1179-2 (Type E)
 Port acc. to ISO 1179-1

Torque recommendations for Steel mating material.

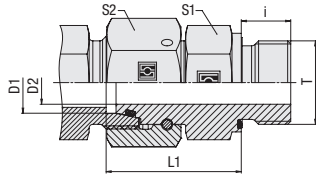

**Straight Male Stud Fitting with 24° Taper / O-Ring
Type FI-EGED-...-M-WD • Series L / S**

Profile Sealing Ring
Metric Parallel Thread

Series	Tube OD (mm/in)	PN (bar/PSI)	Dimensions (mm/in)					Torque (N·m/ft·lb)	Weight (kg/lbs) ca.	Ordering Codes	
			Thread T	D2	i	L1	S1				S2
L	6	500	M10x1	2,5	8	24,5	14	14	18	3,76	FI-EGED-06LM-WD-B-W3-DKO
	.24	7250		.10	.31	.96	.55	.55	13.3	8.27	
	8	500	M12x1,5	4	12	26,5	17	17	25	4,64	FI-EGED-08LM-WD-B-W3-DKO
	.31	7250		.16	.47	1.04	.67	.67	18.5	10.21	
	10	500	M14x1,5	6	12	27,5	19	19	45	5,97	FI-EGED-10LM-WD-B-W3-DKO
	.39	7250		.24	.47	1.08	.75	.75	33.3	13.14	
	12	400	M16x1,5	8	12	30,5	22	22	55	9,58	FI-EGED-12LM-WD-B-W3-DKO
	.47	5800		.31	.47	1.20	.87	.87	40.7	21.08	
	15	400	M18x1,5	10	12	31,5	24	27	70	12,62	FI-EGED-15LM-WD-B-W3-DKO
	.59	5800		.39	.47	1.24	.94	1.06	51.8	27.76	
	18	400	M22x1,5	13	14	31,5	27	32	125	15,28	FI-EGED-18LM-WD-B-W3-DKO
	.71	5800		.51	.55	1.24	1.06	1.26	92.5	33.62	
	22	250	M26x1,5	17	16	32,5	32	36	180	20,75	FI-EGED-22LM-WD-B-W3-DKO
	.87	3625		.67	.63	1.28	1.26	1.42	133.2	45.64	
	28	250	M33x2	22	18	35	41	41	310	28,61	FI-EGED-28LM-WD-B-W3-DKO
	1.10	3625		.87	.71	1.38	1.61	1.61	229.4	62.95	
	35	250	M42x2	28	20	42,5	50	50	450	52,30	FI-EGED-35LM-WD-B-W3-DKO
	1.38	3625		1.10	.79	1.67	1.97	1.97	333.0	115.06	
42	250	M48x2	34	22	46,5	55	60	540	72,56	FI-EGED-42LM-WD-B-W3-DKO	
1.65	3625		1.34	.87	1.83	2.17	2.36	399.6	159.62		
S	6	800	M12x1,5	2,5	12	27	17	17	35	4,88	FI-EGED-06SM-WD-B-W3-DKO
	.24	11600		.10	.47	1.06	.67	.67	25.9	10.73	
	8	800	M14x1,5	4	12	29,5	19	19	55	6,59	FI-EGED-08SM-WD-B-W3-DKO
	.31	11600		.16	.47	1.16	.75	.75	40.7	14.49	
	10	800	M16x1,5	6	12	32	22	22	70	9,34	FI-EGED-10SM-WD-B-W3-DKO
	.39	11600		.24	.47	1.26	.87	.87	51.80	20.54	
	12	630	M18x1,5	8	12	34	24	24	90	10,44	FI-EGED-12SM-WD-B-W3-DKO
	.47	9135		.31	.47	1.34	.94	.94	66.6	22.97	
	14	630	M20x1,5	9	14	36,5	27	27	125	16,00	FI-EGED-14SM-WD-B-W3-DKO
	.55	9135		.35	.55	1.44	1.06	1.06	92.5	35.21	
	16	630	M22x1,5	11	14	37	27	30	135	17,32	FI-EGED-16SM-WD-B-W3-DKO
	.63	9135		.43	.55	1.46	1.06	1.18	99.9	38.11	
	20	400	M27x2	14	16	43	32	36	180	27,99	FI-EGED-20SM-WD-B-W3-DKO
	.79	5800		.55	.63	1.69	1.26	1.42	133.2	61.58	
	25	400	M33x2	18	18	48	41	46	310	50,00	FI-EGED-25SM-WD-B-W3-DKO
	.98	5800		.71	.71	1.89	1.61	1.81	229.4	110.00	
	30	400	M42x2	23	20	51	50	50	450	70,30	FI-EGED-30SM-WD-B-W3-DKO
	1.18	5800		.91	.79	2.01	1.97	1.97	333.0	154.66	
38	400	M48x2	30	22	60	55	60	540	94,50	FI-EGED-38SM-WD-B-W3-DKO	
1.50	5800		1.18	.87	2.36	2.17	2.36	399.6	207.90		

Ordering Codes
***FI-EGED*-10*L*M*-WD*-B*-W3*-DKO**

* Straight Male Stud Fitting with 24° Taper / O-Ring (DKO) **FI-EGED**

* Outside Tube Diameter D1 (in mm) **-10**

* Series Light Series **L**
Heavy Series **S**

* Thread Type Metric Parallel Thread **M**

If required, please indicate special sizes, e.g. M12x1.5!

* Seal Type Profile Sealing Ring **-WD**

* Seal Material NBR (Buna-N®) **-B**
FKM (Viton®) **-V**
Male Stud: NBR (Buna-N®) 24° Taper: FKM (Viton®) **-BV**
EPDM **-E**

* Material Code Steel, zinc/nickel-plated **-W3**

Please contact STAUFF for alternative materials and surface finishings.

* Assembling / Kitting Fitting body supplied with swivel nut and O-ring **-DKO**

Spare Parts / Accessories

O-Ring Type **O-RING** Page 207

Profile Sealing Ring Type **WDG** Page 206

Standard seal material is NBR (Buna-N®).

Male stud acc. to ISO 9974-2 (Type E)
Port acc. to ISO 9974-1

Torque recommendations for Steel mating material.



**Straight Fitting with 24° Taper / O-Ring
Type FI-SNV • Series L / S**

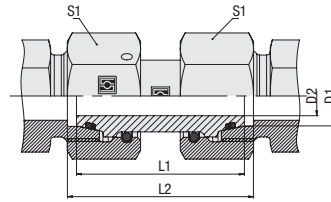

Ordering Codes

***FI-SNV*-10*L*-B*-W3*-DKO**

- * Straight Fitting with 24° Taper / O-Ring (DKO) **FI-SNV**
- * Outside Tube Diameter D1 (in mm) **-10**
- * Series **L**
Light Series
SHeavy Series
- * Seal Material **-B**
NBR (Buna-N®)
-VFKM (Viton®)
-EEPDM
- * Material Code **-W3**
Steel, zinc/nickel-plated
- Please contact STAUFF for alternative materials and surface finishings.
- * Assembling / Kitting Fitting body supplied with swivel nuts and O-rings **-DKO**

Spare Parts / Accessories



O-Ring
Type **O-RING**

Page 207

Series	Tube OD	PN	Dimensions				Weight (% / lbs) ca. per 100	Ordering Codes
	(mm/in) D1		(bar/psi)	(mm/in) D2	L1	L2		
L	6	500	3	34	36,7	14	3,82	FI-SNV-06L-B-W3-DKO
	.24	7250	.12	1.34	1.44	.55	8.40	
	8	500	5	34	36,7	17	4,29	FI-SNV-08L-B-W3-DKO
	.31	7250	.20	1.34	1.44	.67	9.44	
	10	500	6	36	37,8	19	5,78	FI-SNV-10L-B-W3-DKO
	.39	7250	.24	1.42	1.49	.75	12.72	
	12	400	8	36	37,8	22	7,00	FI-SNV-12L-B-W3-DKO
	.47	5800	.31	1.42	1.49	.87	15.40	
	15	400	11	39	40,8	27	12,58	FI-SNV-15L-B-W3-DKO
	.59	5800	.43	1.54	1.61	1.06	27.68	
	18	400	13	40,5	43,3	32	17,59	FI-SNV-18L-B-W3-DKO
	.71	5800	.51	1.59	1.70	1.26	38.70	
	22	250	17	45	47,8	36	24,91	FI-SNV-22L-B-W3-DKO
	.87	3625	.67	1.77	1.88	1.42	54.80	
	28	250	23	46	48,8	41	27,40	FI-SNV-28L-B-W3-DKO
	1.10	3625	.91	1.81	1.92	1.61	60.28	
	35	250	28	53	59	50	45,98	FI-SNV-35L-B-W3-DKO
	1.38	3625	1.10	2.09	2.32	1.97	101.15	
42	250	35	53	60	60	69,50	FI-SNV-42L-B-W3-DKO	
1.65	3625	1.38	2.09	2.36	2.36	152.90		
S	6	800	3	37	39,7	17	4,52	FI-SNV-06S-B-W3-DKO
	.24	11600	.12	1.46	1.56	.67	9.95	
	8	800	4	37	39,7	19	6,03	FI-SNV-08S-B-W3-DKO
	.31	11600	.16	1.46	1.56	.75	13.27	
	10	800	6	41	43,8	22	8,39	FI-SNV-10S-B-W3-DKO
	.39	11600	.24	1.61	1.72	.87	18.47	
	12	630	8	42	44,8	24	10,51	FI-SNV-12S-B-W3-DKO
	.47	9135	.31	1.65	1.76	.94	23.13	
	14	630	9	45	48,8	27	13,90	FI-SNV-14S-B-W3-DKO
	.55	9135	.35	1.77	1.92	1.06	30.59	
	16	630	10	46	50,8	30	17,57	FI-SNV-16S-B-W3-DKO
	.63	9135	.39	1.81	2.00	1.18	38.66	
	20	400	13	55	61	36	24,36	FI-SNV-20S-B-W3-DKO
	.79	5800	.51	2.17	2.40	1.42	53.59	
	25	400	18	58	67	46	49,45	FI-SNV-25S-B-W3-DKO
	.98	5800	.71	2.28	2.64	1.81	108.79	
	30	400	20	62	74	50	61,40	FI-SNV-30S-B-W3-DKO
	1.18	5800	.79	2.44	2.91	1.97	135.08	
38	400	30	67	84	60	86,70	FI-SNV-38S-B-W3-DKO	
1.50	5800	1.18	2.64	3.31	2.36	190.74		

Standard seal material is NBR (Buna-N®).



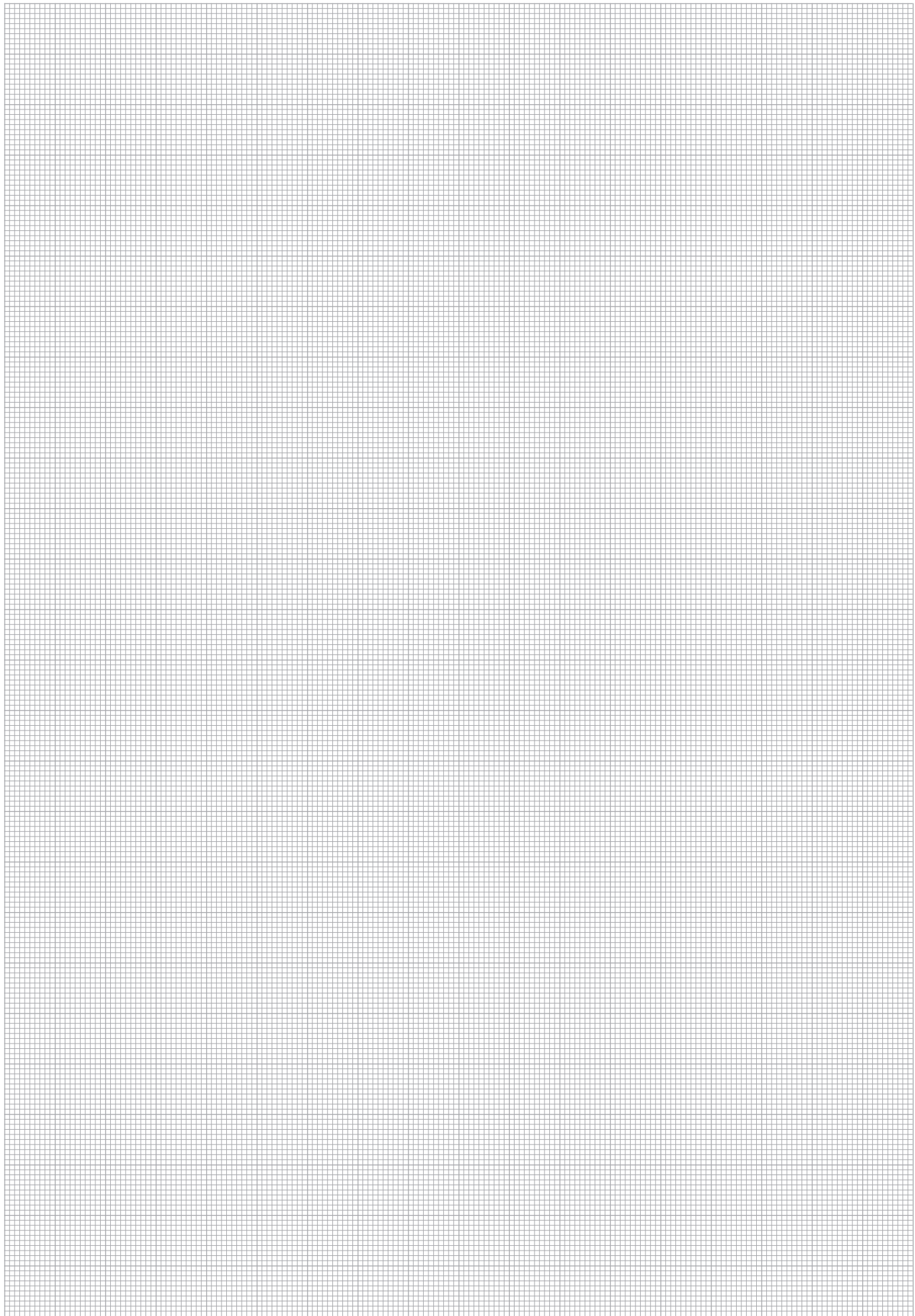

H



**Straight Reducer with 24° Taper / O-Ring
Type FI-SNV • Series L**

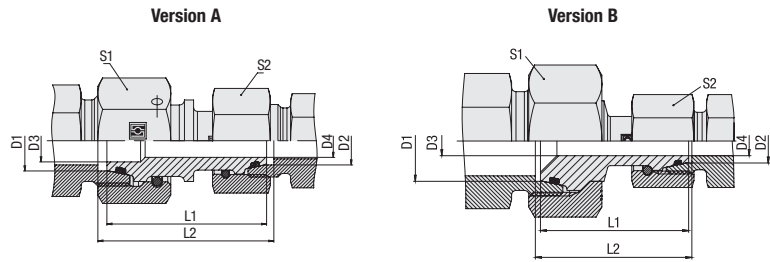

Ordering Codes

***FI-SNV*-10/*08*L*-B*-W3*-DKO**

- * Straight Reducer with 24° Taper / O-Ring (DKO) **FI-SNV**
 - * Outside Tube Diameter D1 (in mm) **-10**
 - * Outside Tube Diameter D2 (in mm) **08**
 - * Series **L**
Light Series (page 120)
Heavy Series (page 121) **S**
 - * Seal Material **-B**
NBR (Buna-N®)
FKM (Viton®) **-V**
EPDM **-E**
 - * Material Code **-W3**
Steel, zinc/nickel-plated
 - * Assembling / Kitting **-DKO**
Fitting body supplied with swivel nuts and O-rings
- Please contact STAUFF for alternative materials and surface finishings.

Spare Parts / Accessories



O-Ring
Type **O-RING**

Page 207

Series	Tube OD		PN (bar/psi)	Dimensions (mm/in)						Version	Weight (kg/lbs) Ca. per 100	Ordering Codes
	D1	D2		D3	D4	L1	L2	S1	S2			
L	8 L	6 L	500	3	3	34	36	17	14	A	4,72	FI-SNV-08/06L-B-W3-DKO
			7250	.12	.12	1.34	1.42	.67	.55		10.38	
	10 L	6 L	500	3	3	35	36,5	19	14	A	5,50	FI-SNV-10/06L-B-W3-DKO
			7250	.12	.12	1.38	1.44	.75	.55		12.10	
	10 L	8 L	500	5	5	35	36,5	19	17	A	5,21	FI-SNV-10/08L-B-W3-DKO
			7250	.20	.20	1.38	1.44	.75	.67		11.47	
	12 L	6 L	400	3	3	35	36,5	22	14	B	18,04	FI-SNV-12/06L-B-W3-DKO
			5800	.12	.12	1.38	1.44	.87	.55		39.68	
	12 L	8 L	400	5	5	36	37,5	22	17	B	6,22	FI-SNV-12/08L-B-W3-DKO
			5800	.20	.20	1.42	1.48	.87	.67		13.69	
	12 L	10 L	400	6,5	6,5	36,5	37,5	22	19	A	6,96	FI-SNV-12/10L-B-W3-DKO
			5800	.26	.26	1.44	1.48	.87	.75		15.31	
	15 L	8 L	400	5	5	36,5	38	27	17	B	1,96	FI-SNV-15/08L-B-W3-DKO
			5800	.20	.20	1.44	1.50	1.06	.67		4.30	
	15 L	10 L	400	6,5	6,5	37,5	38,5	27	19	B	4,40	FI-SNV-15/10L-B-W3-DKO
			5800	.26	.26	1.48	1.52	1.06	.75		9.69	
	15 L	12 L	400	8	8	44	45	27	22	A	11,69	FI-SNV-15/12L-B-W3-DKO
			5800	.31	.31	1.73	1.77	1.06	.87		25.73	
	18 L	10 L	400	6,5	6,5	38	39,5	32	19	B	12,68	FI-SNV-18/10L-B-W3-DKO
			5800	.26	.26	1.50	1.56	1.26	.75		27.89	
	18 L	12 L	400	8	8	38	39,5	32	22	B	13,51	FI-SNV-18/12L-B-W3-DKO
			5800	.31	.31	1.50	1.56	1.26	.87		29.72	
	18 L	15 L	400	11	11	45	46,5	32	27	A	16,60	FI-SNV-18/15L-B-W3-DKO
			5800	.43	.43	1.77	1.83	1.26	1.06		36.51	
22 L	12 L	250	8	8	40,5	42	36	22	B	17,52	FI-SNV-22/12L-B-W3-DKO	
		3625	.31	.31	1.59	1.65	1.42	.87		38.55		
22 L	15 L	250	11	11	42	43,5	36	27	B	19,83	FI-SNV-22/15L-B-W3-DKO	
		3625	.43	.43	1.65	1.71	1.42	1.06		43.63		
22 L	18 L	250	13	13	45	47	36	32	A	23,35	FI-SNV-22/18L-B-W3-DKO	
		3625	.51	.51	1.77	1.85	1.42	1.26		51.37		
28 L	15 L	250	11	11	43	44,5	41	27	B	23,86	FI-SNV-28/15L-B-W3-DKO	
		3625	.43	.43	1.69	1.75	1.61	1.06		52.50		
28 L	18 L	250	13	13	45	47	41	32	B	26,44	FI-SNV-28/18L-B-W3-DKO	
		3625	.51	.51	1.77	1.85	1.61	1.26		58.16		
28 L	22 L	250	17	17	46	48	41	36	B	28,93	FI-SNV-28/22L-B-W3-DKO	
		3625	.67	.67	1.81	1.89	1.61	1.42		63.65		
35 L	18 L	250	13	13	48	51,5	50	32	B	39,52	FI-SNV-35/18L-B-W3-DKO	
		3625	.51	.51	1.89	2.03	1.97	1.26		86.94		
35 L	22 L	250	17	17	49,5	53	50	36	B	41,34	FI-SNV-35/22L-B-W3-DKO	
		3625	.67	.67	1.95	2.09	1.97	1.42		90.95		
35 L	28 L	250	23	23	50	53,5	50	41	B	40,71	FI-SNV-35/28L-B-W3-DKO	
		3625	.91	.91	1.97	2.11	1.97	1.61		89.57		
42 L	22 L	250	17	17	49,5	53,5	60	36	B	56,50	FI-SNV-42/22L-B-W3-DKO	
		3625	.67	.67	1.95	2.11	2.36	1.42		124.30		
42 L	28 L	250	23	23	50	54	60	41	B	56,10	FI-SNV-42/28L-B-W3-DKO	
		3625	.91	.91	1.97	2.13	2.36	1.61		123.42		
42 L	35 L	250	28	28	53	58,5	60	50	B	60,70	FI-SNV-42/35L-B-W3-DKO	
		3625	1.10	1.10	2.09	2.30	2.36	1.97		133.54		

Standard seal material is NBR (Buna-N®).

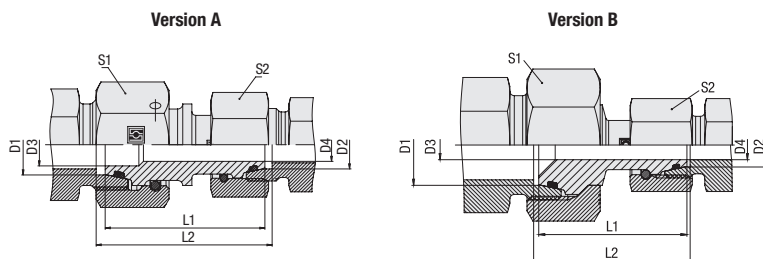

**Straight Reducer with 24° Taper / O-Ring
Type FI-SNV • Series S**

Series	Tube OD (mm/in)		PN (bar/psi)	Dimensions (mm/in)						Version	Weight (kg/lbs) ca. per 100	Ordering Codes
	D1	D2		D3	D4	L1	L2	S1	S2			
S	6S	6L	500	3	3	35,5	37	17	14	A	3,70	FI-SNV-06S/06L-B-W3-DKO
			7250	.12	.12	1.40	1.46	.67	.55		8.14	
8 S	8 L	8 L	500	4	4	35,5	36,5	17	19	A	5,27	FI-SNV-08S/08L-B-W3-DKO
			7250	.16	.16	1.40	1.44	.67	.75		11.60	
10 S	6 S	6 S	800	3	3	40,5	42,5	22	17	A	6,30	FI-SNV-10/06S-B-W3-DKO
			11600	.12	.12	1.59	1.67	.87	.67		13.86	
10 S	8 S	8 S	800	4	4	39	41	22	19	A	7,60	FI-SNV-10/08S-B-W3-DKO
			11600	.16	.16	1.54	1.61	.87	.75		16.72	
12 S	6 S	6 S	630	3	3	39	43	24	17	B	7,79	FI-SNV-12/06S-B-W3-DKO
			9135	.12	.12	1.54	1.69	.94	.67		17.13	
12 S	8 S	8 S	630	4	4	44	46	24	19	A	9,42	FI-SNV-12/08S-B-W3-DKO
			9135	.16	.16	1.73	1.81	.94	.75		20.72	
12 S	10 S	10 S	630	6,5	6,5	41,5	43,5	24	22	A	9,73	FI-SNV-12/10S-B-W3-DKO
			9135	.26	.26	1.63	1.71	.94	.87		21.40	
16 S	10 S	10 S	630	6,5	6,5	43,5	46,5	30	22	B	14,11	FI-SNV-16/10S-B-W3-DKO
			9135	.26	.26	1.71	1.83	1.18	.87		31.03	
16 S	12 S	12 S	630	8	8	47,5	50,5	30	24	A	15,32	FI-SNV-16/12S-B-W3-DKO
			9135	.31	.31	1.87	1.99	1.18	.94		33.70	
20 S	12 S	12 S	400	8	8	48,5	52	36	24	B	21,90	FI-SNV-20/12S-B-W3-DKO
			5800	.31	.31	1.91	2.05	1.42	.94		48.18	
20 S	16 S	16 S	400	11	11	52,5	57	36	30	A	24,68	FI-SNV-20/16S-B-W3-DKO
			5800	.43	.43	2.07	2.24	1.42	1.18		54.30	
25 S	16 S	16 S	400	11	11	52	58	46	30	A	34,02	FI-SNV-25/16S-B-W3-DKO
			5800	.43	.43	2.05	2.28	1.81	1.18		74.84	
25 S	20 S	20 S	400	14	14	58	64,5	46	36	A	39,77	FI-SNV-25/20S-B-W3-DKO
			5800	.55	.55	2.28	2.54	1.81	1.42		87.49	
30 S	16 S	16 S	400	11	11	54	61,5	50	30	B	47,00	FI-SNV-30/16S-B-W3-DKO
			5800	.43	.43	2.13	2.42	1.97	1.18		103.40	
30 S	20 S	20 S	400	14	14	58,5	66,5	50	36	B	51,00	FI-SNV-30/20S-B-W3-DKO
			5800	.55	.55	2.30	2.62	1.97	1.42		112.20	
30 S	25 S	25 S	400	17	17	60	69,5	50	46	A	56,80	FI-SNV-30/25S-B-W3-DKO
			5800	.67	.67	2.36	2.74	1.97	1.81		124.96	
38 S	20 S	20 S	400	14	14	61	71,5	60	36	B	71,30	FI-SNV-38/20S-B-W3-DKO
			5800	.55	.55	2.40	2.81	2.36	1.42		156.86	
38 S	25 S	25 S	400	17	17	62,5	74,5	60	46	B	80,70	FI-SNV-38/25S-B-W3-DKO
			5800	.67	.67	2.46	2.93	2.36	1.81		177.54	
38 S	30 S	30 S	400	22	22	64,5	78	60	50	A	76,90	FI-SNV-38/30S-B-W3-DKO
			5800	.87	.87	2.54	3.07	2.36	1.97		169.18	

Ordering Codes
***FI-SNV*-10/*08*L*-B*-W3*-DKO**

- * Straight Reducer with 24° Taper / O-Ring (DKO) FI-SNV
- * Outside Tube Diameter D1 (in mm) -10
- * Outside Tube Diameter D2 (in mm) 08
- * Series L
Light Series (page 120)
S
Heavy Series (page 121)
- * Seal Material -B
NBR (Buna-N®)
-V
FKM (Viton®)
-E
EPDM
- * Material Code -W3
Steel, zinc/nickel-plated
- * Assembling / Kitting -DKO
Fitting body supplied with swivel nuts and O-rings

Spare Parts / Accessories

 O-Ring
Type **O-RING**

Page 207

Standard seal material is NBR (Buna-N®).



Straight Reducer for Tube Ends with 24° Taper / O-Ring
Type FI-RESDS • Series L

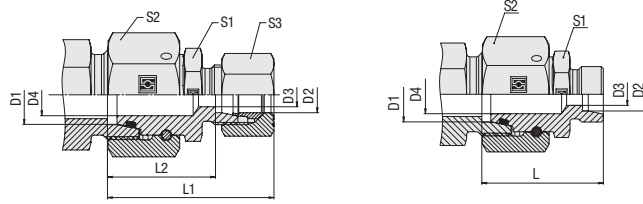

Ordering Codes

***FI-RESDS*-10/*08*L*-B*-W3*-DKO*-MS**

* Straight Reducer for Tube Ends with 24° Taper / O-Ring (DKO) **FI-RESDS**

* Outside Tube Diameter D1 (in mm) **-10**

* Outside Tube Diameter D2 (in mm) **08**

* Series Light Series (pages 122/123) **L**
 Heavy Series (pages 124/125) **S**

* Seal Material NBR (Buna-N®) **-B**
 FKM (Viton®) **-V**
 EPDM **-E**

* Material Code Steel, zinc/nickel-plated **-W3**

Please contact STAUFF for alternative materials and surface finishings.

* Assembling / Kitting Fitting body supplied with swivel nut and O-ring **-DKO**

Fitting body supplied with cutting ring and union nut **-MS**

Fitting body supplied with soft-sealing cutting ring and union nut **-MSV**

Connecting Parts

-  Cutting Ring Type **FI-DS** Page 26
-  Soft-Sealing Cutting Ring Type **FI-WDDS** Page 27
-  Support Sleeve Type **FI-VH** Page 28
-  STAUFF Form Ring Type **FI-AR** Page 30
-  Union Nut Type **FI-M** Page 31
-  37° Flared Tube Fitting Set Type **FI-AB** Page 35

Spare Parts / Accessories

-  O-Ring Type **O-RING** Page 207

Series	Tube OD (mm/in)		PN (bar/psi)	Dimensions (mm/in)									Weight (kg/lbs) ca. per 100 ²	Ordering Codes ³
	D1	D2		D3	D4	L	L ¹	L2	S1	S2	S3			
L	8	6	500	4	4	30	38	23,5	12	17	14	3,01	FI-RESDS-08/06L-B-W3-DKO	
	.31	.24	7250	.16	.16	1.18	1.50	.93	.47	.67	.55	6,61	FI-RESDS-10/06L-B-W3-DKO	
	10	6	500	4	4	32	40	25	14	19	14	3,80	FI-RESDS-10/08L-B-W3-DKO	
	.39	.24	7250	.16	.16	1.26	1.57	.98	.55	.75	.55	8,36	FI-RESDS-12/06L-B-W3-DKO	
	10	8	500	6	6	32	40	25	14	19	17	3,99	FI-RESDS-12/08L-B-W3-DKO	
	.39	.31	7250	.24	.24	1.26	1.57	.98	.55	.75	.67	8,78	FI-RESDS-12/10L-B-W3-DKO	
	12	6	400	4	4	32	40	25	17	22	14	5,69	FI-RESDS-12/10L-B-W3-DKO	
	.47	.24	5800	.16	.16	1.26	1.57	.98	.67	.87	.55	12,52	FI-RESDS-15/06L-B-W3-DKO	
	12	8	400	6	6	32	40	25	17	22	17	5,53	FI-RESDS-15/08L-B-W3-DKO	
	.47	.31	5800	.24	.24	1.26	1.57	.98	.67	.87	.67	12,17	FI-RESDS-15/10L-B-W3-DKO	
	12	10	400	8	8	33	41	26	17	22	19	5,33	FI-RESDS-15/12L-B-W3-DKO	
	.47	.39	5800	.31	.31	1.30	1.61	1.02	.67	.87	.75	11,72	FI-RESDS-15/15L-B-W3-DKO	
	15	6	400	4	11	35	43	29	22	27	14	8,83	FI-RESDS-15/15L-B-W3-DKO	
	.59	.24	5800	.16	.43	1.38	1.69	1.14	.87	1.06	.55	19,43	FI-RESDS-15/15L-B-W3-DKO	
	15	8	400	6	11	35	43	29	22	27	17	9,08	FI-RESDS-15/15L-B-W3-DKO	
	.59	.31	5800	.24	.43	1.38	1.69	1.14	.87	1.06	.67	19,98	FI-RESDS-15/15L-B-W3-DKO	
	15	10	400	8	8	35	43	30	22	27	19	9,61	FI-RESDS-15/15L-B-W3-DKO	
	.59	.39	5800	.31	.31	1.38	1.69	1.18	.87	1.06	.75	21,14	FI-RESDS-15/15L-B-W3-DKO	
	15	12	400	10	10	36	44	30	22	27	22	9,25	FI-RESDS-15/15L-B-W3-DKO	
	.59	.47	5800	.39	.39	1.42	1.73	1.18	.87	1.06	.87	20,35	FI-RESDS-15/15L-B-W3-DKO	
	18	6	400	4	13	35	43	28	24	32	14	11,07	FI-RESDS-18/06L-B-W3-DKO	
	.71	.24	5800	.16	.51	1.38	1.69	1.10	.94	1.26	.55	24,36	FI-RESDS-18/08L-B-W3-DKO	
	18	8	400	6	13	35	43	28	24	32	17	7,57	FI-RESDS-18/08L-B-W3-DKO	
	.71	.31	5800	.24	.51	1.38	1.69	1.10	.94	1.26	.67	16,66	FI-RESDS-18/10L-B-W3-DKO	
	18	10	400	8	8	36	44	29	24	32	19	12,64	FI-RESDS-18/10L-B-W3-DKO	
	.71	.39	5800	.31	.31	1.42	1.73	1.14	.94	1.26	.75	27,81	FI-RESDS-18/12L-B-W3-DKO	
	18	12	400	10	10	36	44	29	24	32	22	12,24	FI-RESDS-18/12L-B-W3-DKO	
	.71	.47	5800	.39	.39	1.42	1.73	1.14	.94	1.26	.87	26,93	FI-RESDS-18/12L-B-W3-DKO	
18	15	400	12	12	37	45	30	24	32	27	12,27	FI-RESDS-18/15L-B-W3-DKO		
.71	.59	5800	.47	.47	1.46	1.77	1.18	.94	1.26	1.06	26,99	FI-RESDS-22/06L-B-W3-DKO		
22	6	250	4	17	38	47	32	27	36	14	16,34	FI-RESDS-22/08L-B-W3-DKO		
.87	.24	3625	.16	.67	1.50	1.85	1.26	1.06	1.42	.55	35,96	FI-RESDS-22/10L-B-W3-DKO		
22	8	250	6	17	38	47	32	27	36	17	16,27	FI-RESDS-22/10L-B-W3-DKO		
.87	.31	3625	.24	.67	1.50	1.85	1.26	1.06	1.42	.67	35,80	FI-RESDS-22/12L-B-W3-DKO		
22	10	250	8	17	39	48	33	27	36	19	16,33	FI-RESDS-22/12L-B-W3-DKO		
.87	.39	3625	.31	.67	1.54	1.89	1.30	1.06	1.42	.75	35,92	FI-RESDS-22/12L-B-W3-DKO		
22	12	250	10	17	39	48	33	27	36	22	16,30	FI-RESDS-22/15L-B-W3-DKO		
.87	.47	3625	.39	.67	1.54	1.89	1.30	1.06	1.42	.87	35,87	FI-RESDS-22/15L-B-W3-DKO		
22	15	250	12	12	40	49	34	27	36	27	19,01	FI-RESDS-22/18L-B-W3-DKO		
.87	.59	3625	.47	.47	1.57	1.93	1.34	1.06	1.42	1.06	41,82	FI-RESDS-22/18L-B-W3-DKO		
22	18	250	15	15	41	50	34	27	36	32	18,13	FI-RESDS-22/18L-B-W3-DKO		
.87	.71	3625	.59	.59	1.61	1.97	1.34	1.06	1.42	1.26	39,89	FI-RESDS-28/06L-B-W3-DKO		
28	6	250	4	23	40	49	34	36	41	14	22,90	FI-RESDS-28/08L-B-W3-DKO		
1.10	.24	3625	.16	.91	1.57	1.93	1.34	1.42	1.61	.55	50,37	FI-RESDS-28/08L-B-W3-DKO		
28	8	250	6	23	40	49	34	36	41	17	20,95	FI-RESDS-28/10L-B-W3-DKO		
1.10	.31	3625	.24	.91	1.57	1.93	1.34	1.42	1.61	.67	46,09	FI-RESDS-28/10L-B-W3-DKO		
28	10	250	8	23	41	50	35	36	41	19	21,74	FI-RESDS-28/12L-B-W3-DKO		
1.10	.39	3625	.31	.91	1.61	1.97	1.38	1.42	1.61	.75	47,83	FI-RESDS-28/12L-B-W3-DKO		
28	12	250	10	23	41	50	35	36	41	22	10,22	FI-RESDS-28/12L-B-W3-DKO		
1.10	.47	3625	.39	.91	1.61	1.97	1.38	1.42	1.61	.87	22,49	FI-RESDS-28/15L-B-W3-DKO		
28	15	250	12	23	42	51	36	36	41	27	18,85	FI-RESDS-28/15L-B-W3-DKO		
1.10	.59	3625	.47	.91	1.65	2.01	1.42	1.42	1.61	1.06	41,47	FI-RESDS-28/18L-B-W3-DKO		
28	18	250	15	23	43	52	36	36	41	32	22,50	FI-RESDS-28/18L-B-W3-DKO		
1.10	.71	3625	.59	.91	1.69	2.05	1.42	1.42	1.61	1.26	49,50	FI-RESDS-28/22L-B-W3-DKO		
28	22	250	19	23	45	54	38	36	41	36	22,80	FI-RESDS-28/22L-B-W3-DKO		
1.10	.87	3625	.75	.91	1.77	2.13	1.50	1.42	1.61	1.42	50,16			

¹ Approximate dimension in assembled condition.

² Weight excluding cutting ring and union nut.

³ Standard scope of delivery: Fitting body only.

Standard seal material is NBR (Buna-N®).

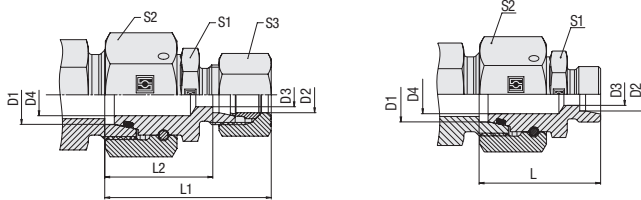

**Straight Reducer for Tube Ends with 24° Taper / O-Ring
Type FI-RESDS - Series L**

Series	Tube OD (mm/in)		PN (bar/psi)	Dimensions (mm/in)									Weight (*10/100) ca. per 100 ²	Ordering Codes ³
	D1	D2		D3	D4	L	L1 ¹	L2	S1	S2	S3			
L	35	6	250	4	28	41	52	37	46	50	14	7,82	FI-RESDS-35/06L-B-W3-DKO	
	1.38	.24	3625	.16	1.10	1.61	2.05	1.46	1.81	1.97	.55	17.20		
	35	8	250	6	28	41	52	37	46	50	17	35,43	FI-RESDS-35/08L-B-W3-DKO	
	1.38	.31	3625	.24	1.10	1.61	2.05	1.46	1.81	1.97	.67	77.95		
	35	10	250	8	28	42	53	38	46	50	19	35,35	FI-RESDS-35/10L-B-W3-DKO	
	1.38	.39	3625	.31	1.10	1.65	2.09	1.50	1.81	1.97	.75	77.77		
	35	12	250	10	28	42	53	38	46	50	22	33,34	FI-RESDS-35/12L-B-W3-DKO	
	1.38	.47	3625	.39	1.10	1.65	2.09	1.50	1.81	1.97	.87	73.34		
	35	15	250	12	28	43	54	39	46	50	27	15,22	FI-RESDS-35/15L-B-W3-DKO	
	1.38	.59	3625	.47	1.10	1.69	2.13	1.54	1.81	1.97	1.06	33.49		
	35	18	250	15	28	44	55	39	46	50	32	34,32	FI-RESDS-35/18L-B-W3-DKO	
	1.38	.71	3625	.59	1.10	1.73	2.17	1.54	1.81	1.97	1.26	75.50		
	35	22	250	19	28	46	57	41	46	50	36	34,80	FI-RESDS-35/22L-B-W3-DKO	
	1.38	.87	3625	.75	1.10	1.81	2.24	1.61	1.81	1.97	1.42	76.57		
	35	28	250	24	24	46	57	41	46	50	41	38,10	FI-RESDS-35/28L-B-W3-DKO	
	1.38	1.10	3625	.94	.94	1.81	2.24	1.61	1.81	1.97	1.61	83.82		
	42	6	250	4	35	36	48	41	50	60	14	52,66	FI-RESDS-42/06L-B-W3-DKO	
	1.65	.24	3625	.16	1.38	1.42	1.89	1.61	1.97	2.36	.55	115.85		
	42	8	250	6	35	36	48	41	50	60	17	52,58	FI-RESDS-42/08L-B-W3-DKO	
	1.65	.31	3625	.24	1.38	1.42	1.89	1.61	1.97	2.36	.67	115.67		
	42	10	250	8	35	44	56	42	50	60	19	52,58	FI-RESDS-42/10L-B-W3-DKO	
	1.65	.39	3625	.31	1.38	1.73	2.20	1.65	1.97	2.36	.75	115.68		
	42	12	250	10	35	44	56	42	50	60	22	52,60	FI-RESDS-42/12L-B-W3-DKO	
	1.65	.47	3625	.39	1.38	1.73	2.20	1.65	1.97	2.36	.87	115.72		
	42	15	250	12	35	46	58	43	50	60	27	52,30	FI-RESDS-42/15L-B-W3-DKO	
	1.65	.59	3625	.47	1.38	1.81	2.28	1.69	1.97	2.36	1.06	115.06		
	42	18	250	15	35	46	58	42	50	60	32	52,00	FI-RESDS-42/18L-B-W3-DKO	
	1.65	.71	3625	.59	1.38	1.81	2.28	1.65	1.97	2.36	1.26	114.40		
	42	22	250	19	35	48	60	44	50	60	36	50,10	FI-RESDS-42/22L-B-W3-DKO	
	1.65	.87	3625	.75	1.38	1.89	2.36	1.73	1.97	2.36	1.42	110.21		
	42	28	250	24	35	49	61	44	50	60	41	50,19	FI-RESDS-42/28L-B-W3-DKO	
	1.65	1.10	3625	.94	1.38	1.93	2.40	1.73	1.97	2.36	1.61	110.43		
	42	35	250	30	30	53	65	43	50	60	50	55,90	FI-RESDS-42/35L-B-W3-DKO	
	1.65	1.38	3625	1.18	1.18	2.09	2.56	1.69	1.97	2.36	1.97	122.98		

¹ Approximate dimension in assembled condition.

² Weight excluding cutting ring and union nut.

³ Standard scope of delivery: Fitting body only.

Standard seal material is NBR (Buna-N®).

Ordering Codes
***FI-RESDS*-10/*08*L*-B*-W3*-DKO*-MS**

 * Straight Reducer for Tube Ends with 24° Taper / O-Ring (DKO) **FI-RESDS**

 * Outside Tube Diameter D1 (in mm) **-10**

 * Outside Tube Diameter D2 (in mm) **08**

 * Series Light Series (pages 122/123) **L**
 Heavy Series (pages 124/125) **S**

 * Seal Material NBR (Buna-N®) **-B**
 FKM (Viton®) **-V**
 EPDM **-E**

 * Material Code Steel, zinc/nickel-plated **-W3**

Please contact STAUFF for alternative materials and surface finishings.

 * Assembling / Kitting Fitting body supplied with swivel nut and O-ring **-DKO**

 Fitting body supplied with cutting ring and union nut **-MS**

 Fitting body supplied with soft-sealing cutting ring and union nut **-MSV**
Connecting Parts

	Cutting Ring Type FI-DS	Page 26
	Soft-Sealing Cutting Ring Type FI-WDDS	Page 27
	Support Sleeve Type FI-VH	Page 28
	STAUFF Form Ring Type FI-AR	Page 30
	Union Nut Type FI-M	Page 31
	37° Flared Tube Fitting Set Type FI-AB	Page 35

Spare Parts / Accessories

	O-Ring Type O-RING	Page 207
--	------------------------------	----------



Straight Reducer for Tube Ends with 24° Taper / O-Ring Type FI-RESDS • Series S

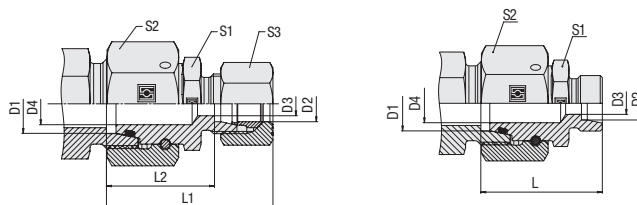

Ordering Codes

***FI-RESDS*-10/*08*S*-B*-W3*-DKO*-MS**

* Straight Reducer for Tube Ends with 24° Taper / O-Ring (DKO) **FI-RESDS**

* Outside Tube Diameter D1 (in mm) **-10**

* Outside Tube Diameter D2 (in mm) **08**

* Series Light Series (pages 122/123) **L**
Heavy Series (pages 124/125) **S**

* Seal Material NBR (Buna-N®) **-B**
FKM (Viton®) **-V**
EPDM **-E**

* Material Code Steel, zinc/nickel-plated **-W3**

Please contact STAUFF for alternative materials and surface finishings.

* Assembling / Kitting Fitting body supplied with swivel nut and O-ring **-DKO**

Fitting body supplied with cutting ring and union nut **-MS**

Fitting body supplied with soft-sealing cutting ring and union nut **-MSV**

Connecting Parts

	Cutting Ring Type FI-DS	Page 26
	Soft-Sealing Cutting Ring Type FI-WDDS	Page 27
	Support Sleeve Type FI-VH	Page 28
	STAUFF Form Ring Type FI-AR	Page 30
	Union Nut Type FI-M	Page 31
	37° Flared Tube Fitting Set Type FI-AB	Page 35

Spare Parts / Accessories

	O-Ring Type O-RING	Page 207
--	------------------------------	----------

Series	Tube OD (mm/in)		PN (bar/psi)	Dimensions (mm/in)							Weight (kg/lbs) ca. per 100 ²	Ordering Codes ³	
	D1	D2		D3	D4	L	L ¹	L2	S1	S2			S3
S	8	6	800	4	4	34	42	27	14	19	17	4,46	FI-RESDS-08/06S-B-W3-DKO
	.31	.24	11600	.16	.16	1.34	1.65	1.06	.55	.75	.67	9.80	FI-RESDS-10/06S-B-W3-DKO
	10	6	800	4	4	33	42	27,5	17	22	17	5,93	FI-RESDS-10/08S-B-W3-DKO
	.39	.24	11600	.16	.16	1.30	1.65	1.08	.67	.87	.67	13.05	FI-RESDS-12/06S-B-W3-DKO
	10	8	800	5	5	33	42	27,5	17	22	19	6,07	FI-RESDS-12/08S-B-W3-DKO
	.39	.31	11600	.20	.20	1.30	1.65	1.08	.67	.87	.75	13.35	FI-RESDS-12/10S-B-W3-DKO
	12	6	630	4	4	33	44	29	19	24	17	7,96	FI-RESDS-14/06S-B-W3-DKO
	.47	.24	9135	.16	.16	1.30	1.73	1.14	.75	.94	.67	17.52	FI-RESDS-14/08S-B-W3-DKO
	12	8	630	5	5	33	44	29	19	24	19	8,04	FI-RESDS-14/10S-B-W3-DKO
	.47	.31	9135	.20	.20	1.30	1.73	1.14	.75	.94	.75	17.68	FI-RESDS-14/12S-B-W3-DKO
	12	10	630	7	7	35	46	29,5	19	24	22	7,90	FI-RESDS-16/06S-B-W3-DKO
	.47	.39	9135	.28	.28	1.38	1.81	1.16	.75	.94	.87	17.38	FI-RESDS-16/08S-B-W3-DKO
	14	6	630	4	4	36	46	32	22	27	17	10,46	FI-RESDS-16/10S-B-W3-DKO
	.55	.24	9135	.16	.16	1.42	1.81	1.26	.87	1.06	.67	23.02	FI-RESDS-16/12S-B-W3-DKO
	14	8	630	5	5	36	46	32	22	27	19	10,53	FI-RESDS-16/14S-B-W3-DKO
	.55	.31	9135	.20	.20	1.42	1.81	1.26	.87	1.06	.75	23.16	FI-RESDS-20/06S-B-W3-DKO
	14	10	630	7	7	37	47	31	22	27	22	10,12	FI-RESDS-20/08S-B-W3-DKO
	.55	.39	9135	.28	.28	1.46	1.85	1.22	.87	1.06	.87	22.27	FI-RESDS-20/10S-B-W3-DKO
	14	12	630	8	8	37	47	31	22	27	24	10,44	FI-RESDS-20/12S-B-W3-DKO
	.55	.47	9135	.31	.31	1.46	1.85	1.22	.87	1.06	.94	22.97	FI-RESDS-20/14S-B-W3-DKO
	16	6	630	4	11	37	47	32	22	30	17	10,79	FI-RESDS-20/16S-B-W3-DKO
	.63	.24	9135	.16	.43	1.46	1.85	1.26	.87	1.18	.67	23.74	FI-RESDS-25/06S-B-W3-DKO
	16	8	630	5	11	37	47	32	22	30	19	11,04	FI-RESDS-25/08S-B-W3-DKO
	.63	.31	9135	.20	.43	1.46	1.85	1.26	.87	1.18	.75	24.29	FI-RESDS-25/10S-B-W3-DKO
	16	10	630	7	7	38	48	31,5	22	30	22	7,67	FI-RESDS-25/12S-B-W3-DKO
	.63	.39	9135	.28	.28	1.50	1.89	1.24	.87	1.18	.87	16.87	FI-RESDS-25/14S-B-W3-DKO
	16	12	630	8	8	38	48	31,5	22	30	24	12,07	FI-RESDS-25/16S-B-W3-DKO
	.63	.47	9135	.31	.31	1.50	1.89	1.24	.87	1.18	.94	26.55	FI-RESDS-25/18S-B-W3-DKO
16	14	630	10	10	41	51	33	24	30	27	12,64	FI-RESDS-25/20S-B-W3-DKO	
.63	.55	9135	.39	.39	1.61	2.01	1.30	.94	1.18	1.06	27.80	FI-RESDS-25/22S-B-W3-DKO	
20	6	400	4	14	40	51	36	27	36	17	17,16	FI-RESDS-25/24S-B-W3-DKO	
.79	.24	5800	.16	.55	1.57	2.01	1.42	1.06	1.42	.67	37.75	FI-RESDS-25/26S-B-W3-DKO	
20	8	400	5	14	40	51	36	27	36	19	17,61	FI-RESDS-25/28S-B-W3-DKO	
.79	.31	5800	.20	.55	1.57	2.01	1.42	1.06	1.42	.75	38.74	FI-RESDS-25/30S-B-W3-DKO	
20	10	400	7	14	41	52	35,5	27	36	22	17,49	FI-RESDS-25/32S-B-W3-DKO	
.79	.39	5800	.28	.55	1.61	2.05	1.40	1.06	1.42	.87	38.48	FI-RESDS-25/34S-B-W3-DKO	
20	12	400	8	14	41	52	35,5	27	36	24	17,76	FI-RESDS-25/36S-B-W3-DKO	
.79	.47	5800	.31	.55	1.61	2.05	1.40	1.06	1.42	.94	39.08	FI-RESDS-25/38S-B-W3-DKO	
20	14	400	10	14	44	55	37	27	36	27	19,83	FI-RESDS-25/40S-B-W3-DKO	
.79	.55	5800	.39	.55	1.73	2.17	1.46	1.06	1.42	1.06	43.62	FI-RESDS-25/42S-B-W3-DKO	
20	16	400	12	12	44	55	36,5	27	36	30	19,34	FI-RESDS-25/44S-B-W3-DKO	
.79	.63	5800	.47	.47	1.73	2.17	1.44	1.06	1.42	1.18	42.56	FI-RESDS-25/46S-B-W3-DKO	
25	6	400	4	18	41	53	38,5	36	46	17	29,87	FI-RESDS-25/48S-B-W3-DKO	
.98	.24	5800	.16	.71	1.61	2.09	1.52	1.42	1.81	.67	65.72	FI-RESDS-25/50S-B-W3-DKO	
25	8	400	5	18	41	53	38,5	36	46	19	30,39	FI-RESDS-25/52S-B-W3-DKO	
.98	.31	5800	.20	.71	1.61	2.09	1.52	1.42	1.81	.75	66.85	FI-RESDS-25/54S-B-W3-DKO	
25	10	400	7	18	42	54	38	36	46	22	16,95	FI-RESDS-25/56S-B-W3-DKO	
.98	.39	5800	.28	.71	1.65	2.13	1.50	1.42	1.81	.87	37.29	FI-RESDS-25/58S-B-W3-DKO	
25	12	400	8	18	42	54	38	36	46	24	30,41	FI-RESDS-25/60S-B-W3-DKO	
.98	.47	5800	.31	.71	1.65	2.13	1.50	1.42	1.81	.94	66.91	FI-RESDS-25/62S-B-W3-DKO	
25	14	400	10	18	45	57	40	36	46	27	30,95	FI-RESDS-25/64S-B-W3-DKO	
.98	.55	5800	.39	.71	1.77	2.24	1.57	1.42	1.81	1.06	68.09	FI-RESDS-25/66S-B-W3-DKO	
25	16	400	12	18	45	57	39	36	46	30	30,29	FI-RESDS-25/68S-B-W3-DKO	
.98	.63	5800	.47	.71	1.77	2.24	1.54	1.42	1.81	1.18	66.65	FI-RESDS-25/70S-B-W3-DKO	
25	20	400	16	16	49	61	39	36	46	36	32,97	FI-RESDS-25/72S-B-W3-DKO	
.98	.79	5800	.63	.63	1.93	2.40	1.54	1.42	1.81	1.42	72.53	FI-RESDS-25/74S-B-W3-DKO	

¹ Approximate dimension in assembled condition.

² Weight excluding cutting ring and union nut.

³ Standard scope of delivery: Fitting body only.

Standard seal material is NBR (Buna-N®).

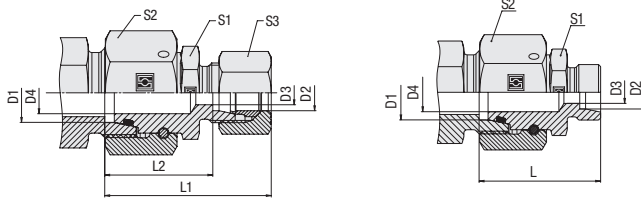

**Straight Reducer for Tube Ends with 24° Taper / O-Ring
Type FI-RESDS • Series S**

Series	Tube OD (mm/in)		PN (bar/psi)	Dimensions (mm/in)							Weight (*10/100) ca. per 100 ²	Ordering Codes ³	
	D1	D2		D3	D4	L	L1 ¹	L2	S1	S2			S3
S	30	6	400	4	22	46	59	44	41	50	17	37,93	FI-RESDS-30/06S-B-W3-DKO
	1.18	.24	5800	.16	.87	1.81	2.32	1.73	1.61	1.97	.67	83.45	
	30	8	400	5	22	46	59	44	41	50	19	31,17	FI-RESDS-30/08S-B-W3-DKO
	1.18	.31	5800	.20	.87	1.81	2.32	1.73	1.61	1.97	.75	68.57	
	30	10	400	7	22	47	60	43,5	41	50	22	38,28	FI-RESDS-30/10S-B-W3-DKO
	1.18	.39	5800	.28	.87	1.85	2.36	1.71	1.61	1.97	.87	84.22	
	30	12	400	8	22	47	60	43,5	41	50	24	38,65	FI-RESDS-30/12S-B-W3-DKO
	1.18	.47	5800	.31	.87	1.85	2.36	1.71	1.61	1.97	.94	85.03	
	30	14	400	10	22	50	63	45	41	50	27	38,88	FI-RESDS-30/14S-B-W3-DKO
	1.18	.55	5800	.39	.87	1.97	2.48	1.77	1.61	1.97	1.06	85.53	
	30	16	400	12	22	50	63	44,5	41	50	30	38,59	FI-RESDS-30/16S-B-W3-DKO
	1.18	.63	5800	.47	.87	1.97	2.48	1.75	1.61	1.97	1.18	84.89	
	30	20	400	16	22	53	66	44,5	41	50	36	39,86	FI-RESDS-30/20S-B-W3-DKO
	1.18	.79	5800	.63	.87	2.09	2.60	1.75	1.61	1.97	1.42	87.69	
	30	25	400	20	20	56	69	45	41	50	46	42,96	FI-RESDS-30/25S-B-W3-DKO
	1.18	.98	5800	.79	.79	2.20	2.72	1.77	1.61	1.97	1.81	94.51	
	38	6	400	4	30	47	62	47,5	50	60	17	55,50	FI-RESDS-38/06S-B-W3-DKO
	1.50	.24	5800	.16	1.18	1.85	2.44	1.87	1.97	2.36	.67	122.10	
	38	8	400	5	30	47	62	47,5	50	60	19	55,50	FI-RESDS-38/08S-B-W3-DKO
	1.50	.31	5800	.20	1.18	1.85	2.44	1.87	1.97	2.36	.75	122.10	
	38	10	400	7	30	48	63	47	50	60	22	56,40	FI-RESDS-38/10S-B-W3-DKO
	1.50	.39	5800	.28	1.18	1.89	2.48	1.85	1.97	2.36	.87	124.08	
	38	12	400	8	30	48	63	47	50	60	24	55,50	FI-RESDS-38/12S-B-W3-DKO
	1.50	.47	5800	.31	1.18	1.89	2.48	1.85	1.97	2.36	.94	122.10	
	38	14	400	10	30	51	66	49	50	60	27	62,87	FI-RESDS-38/14S-B-W3-DKO
	1.50	.55	5800	.39	1.18	2.01	2.60	1.93	1.97	2.36	1.06	138.32	
	38	16	400	12	30	51	66	48	50	60	30	55,80	FI-RESDS-38/16S-B-W3-DKO
	1.50	.63	5800	.47	1.18	2.01	2.60	1.89	1.97	2.36	1.18	122.76	
	38	20	400	16	30	55	70	48	50	60	36	57,40	FI-RESDS-38/20S-B-W3-DKO
	1.50	.79	5800	.63	1.18	2.17	2.76	1.89	1.97	2.36	1.42	126.28	
	38	25	400	20	30	58	73	48,5	50	60	46	59,30	FI-RESDS-38/25S-B-W3-DKO
	1.50	.98	5800	.79	1.18	2.28	2.87	1.91	1.97	2.36	1.81	130.46	
	38	30	400	25	25	61	76	49	50	60	50	63,70	FI-RESDS-38/30S-B-W3-DKO
	1.50	1.18	5800	.98	.98	2.40	2.99	1.93	1.97	2.36	1.97	140.14	

¹ Approximate dimension in assembled condition.

² Weight excluding cutting ring and union nut.

³ Standard scope of delivery: Fitting body only.

Standard seal material is NBR (Buna-N®).

Ordering Codes
***FI-RESDS*-10/*08*S*-B*-W3*-DKO*-MS**

- * Straight Reducer for Tube Ends with 24° Taper / O-Ring (DKO) **FI-RESDS**
- * Outside Tube Diameter D1 (in mm) **-10**
- * Outside Tube Diameter D2 (in mm) **08**
- * Series Light Series (pages 122/123) **L**
Heavy Series (pages 124/125) **S**
- * Seal Material NBR (Buna-N®) **-B**
FKM (Viton®) **-V**
EPDM **-E**
- * Material Code Steel, zinc/nickel-plated **-W3**

Please contact STAUFF for alternative materials and surface finishings.

- * Assembling / Kitting Fitting body supplied with swivel nut and O-ring **-DKO**
Fitting body supplied with cutting ring and union nut **-MS**
Fitting body supplied with soft-sealing cutting ring and union nut **-MSV**

Connecting Parts

-  Cutting Ring Type **FI-DS** Page 26
-  Soft-Sealing Cutting Ring Type **FI-WDDS** Page 27
-  Support Sleeve Type **FI-VH** Page 28
-  STAUFF Form Ring Type **FI-AR** Page 30
-  Union Nut Type **FI-M** Page 31
-  37° Flared Tube Fitting Set Type **FI-AB** Page 35

Spare Parts / Accessories

-  O-Ring Type **O-RING** Page 207



Adjustable Elbow (90°) with 24° Taper / O-Ring
Type FI-EWD ▪ Series L / S

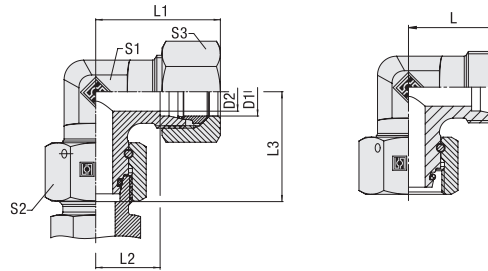

Ordering Codes

***FI-EWD*-10*L*-B*-W3*-DKO*-MS**

- * Adjustable Elbow (90°) with 24° Taper / O-Ring (DKO) **FI-EWD**
 - * Outside Tube Diameter D1 (in mm) **-10**
 - * Series **L** (Light Series) **S** (Heavy Series)
 - * Seal Material **-B** (NBR (Buna-N®)) **-V** (FKM (Viton®)) **-E** (EPDM)
 - * Material Code **-W3** (Steel, zinc/nickel-plated)
 - * Assembling / Kitting **-DKO** (Fitting body supplied with swivel nut and O-ring) **-MS** (Fitting body supplied with cutting ring and union nut) **-MSV** (Fitting body supplied with soft-sealing cutting ring and union nut)
- Please contact STAUFF for alternative materials and surface finishings.

Connecting Parts

- Cutting Ring Type **FI-DS** Page 26
- Soft-Sealing Cutting Ring Type **FI-WDDS** Page 27
- Support Sleeve Type **FI-VH** Page 28
- STAUFF Form Ring Type **FI-AR** Page 30
- Union Nut Type **FI-M** Page 31
- 37° Flared Tube Fitting Set Type **FI-AB** Page 35

Spare Parts / Accessories

- O-Ring Type **O-RING** Page 207

Series	Tube OD	PN	Dimensions							Weight (% _{ms}) ca. per 100 ²	Ordering Codes ³	
	(mm/in) D1		(bar/psi)	(mm/in) D2	L	L1 ¹	L2	L3	S1			S2
L	6	500	4	19	27	12	26	12	14	14	4,00	FI-EWD-06L-B-W3-DKO
	.24	7250	.16	.75	1.06	.47	1.02	.47	.55	.55	8.81	FI-EWD-08L-B-W3-DKO
	8	500	6	21	29	14	27,5	12	17	17	4,03	FI-EWD-08L-B-W3-DKO
	.31	7250	.24	.83	1.14	.55	1.08	.47	.67	.67	8.86	FI-EWD-10L-B-W3-DKO
	10	500	8	22	30	15	29	14	19	19	5,36	FI-EWD-10L-B-W3-DKO
	.39	7250	.31	.87	1.18	.59	1.14	.55	.75	.75	11.78	FI-EWD-12L-B-W3-DKO
	12	400	10	24	32	17	29,5	17	22	22	7,60	FI-EWD-12L-B-W3-DKO
	.47	5800	.39	1.24	1.26	.67	1.16	.67	.87	.87	16.72	FI-EWD-15L-B-W3-DKO
	15	400	12	28	36	21	32,5	19	27	27	12,50	FI-EWD-15L-B-W3-DKO
	.59	5800	.47	1.10	1.42	.83	1.28	.75	1.06	1.06	27.50	FI-EWD-18L-B-W3-DKO
	18	400	15	31	40	23,5	35,5	24	32	32	18,23	FI-EWD-18L-B-W3-DKO
	.71	5800	.59	1.22	1.57	.93	1.40	.94	1.26	1.26	40.11	FI-EWD-22L-B-W3-DKO
	22	400	19	35	44	27,5	38,5	27	36	36	24,57	FI-EWD-22L-B-W3-DKO
	.87	5800	.75	1.38	1.73	1.08	1.52	1.06	1.42	1.42	54.05	FI-EWD-28L-B-W3-DKO
	28	250	24	38	47	30,5	41,5	36	41	41	34,95	FI-EWD-28L-B-W3-DKO
	1.10	3625	.94	1.50	1.85	1.20	1.63	1.42	1.61	1.61	76.89	FI-EWD-35L-B-W3-DKO
	35	250	30	45	56	34,5	51	41	50	50	56,50	FI-EWD-35L-B-W3-DKO
	1.38	3625	1.18	1.77	2.20	1.36	2.01	1.61	1.97	1.97	124.30	FI-EWD-42L-B-W3-DKO
42	250	36	51	63	40	56	50	60	60	85,10	FI-EWD-42L-B-W3-DKO	
1.65	3625	1.42	2.01	2.48	1.57	2.20	1.97	2.36	2.36	187.22	FI-EWD-06S-B-W3-DKO	
S	6	800	4	23	31	16	27	12	17	17	4,67	FI-EWD-06S-B-W3-DKO
	.24	11600	.16	.91	1.22	.63	1.06	.47	.67	.67	10.27	FI-EWD-08S-B-W3-DKO
	8	800	5	24	32	17	27,5	14	19	19	6,29	FI-EWD-08S-B-W3-DKO
	.31	11600	.20	.94	1.26	.67	1.08	.55	.75	.75	13.84	FI-EWD-10S-B-W3-DKO
	10	800	7	25	34	17,5	30	17	22	22	8,58	FI-EWD-10S-B-W3-DKO
	.39	11600	.28	.98	1.34	.69	1.18	.67	.87	.87	18.87	FI-EWD-12S-B-W3-DKO
	12	630	8	29	38	21,5	31	17	24	24	11,02	FI-EWD-12S-B-W3-DKO
	.47	9135	.31	1.14	1.50	.85	1.22	.67	.94	.94	24.24	FI-EWD-14S-B-W3-DKO
	14	630	10	30	40	22	35	19	27	27	14,34	FI-EWD-14S-B-W3-DKO
	.55	9135	.39	1.18	1.57	.87	1.38	.75	1.06	1.06	31.54	FI-EWD-16S-B-W3-DKO
	16	630	12	33	43	24,5	36,5	24	30	30	19,26	FI-EWD-16S-B-W3-DKO
	.63	9135	.47	1.30	1.69	.96	1.44	.94	1.18	1.18	42.38	FI-EWD-20S-B-W3-DKO
	20	400	16	37	48	26,5	44,5	27	36	36	29,86	FI-EWD-20S-B-W3-DKO
	.79	5800	.63	1.46	1.89	1.04	1.75	1.06	1.42	1.42	65.70	FI-EWD-25S-B-W3-DKO
	25	400	20	42	54	30	50	36	46	46	53,20	FI-EWD-25S-B-W3-DKO
	.98	5800	.79	1.65	2.13	1.18	1.97	1.42	1.81	1.81	117.04	FI-EWD-30S-B-W3-DKO
	30	400	25	49	62	35,5	55	41	50	50	72,50	FI-EWD-30S-B-W3-DKO
	1.18	5800	.98	1.93	2.44	1.40	2.17	1.61	1.97	1.97	159.50	FI-EWD-38S-B-W3-DKO
38	400	32	57	72	41	63	50	60	60	109,40	FI-EWD-38S-B-W3-DKO	
1.50	5800	1.26	2.24	2.83	1.61	2.48	1.97	2.36	2.36	240.68		

¹ Approximate dimension in assembled condition.
² Weight excluding cutting ring and union nut.
³ Standard scope of delivery: Fitting body only.



Typical application with a Straight Male Stud Fitting FI-GE-...

Standard seal material is NBR (Buna-N®).

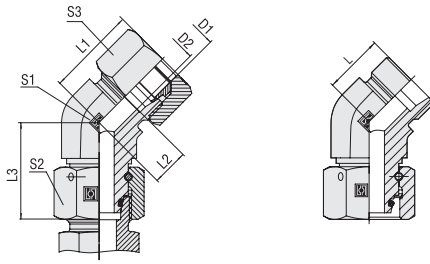

**Adjustable Elbow (45°) with 24° Taper / O-Ring
Type FI-EVD • Series L / S**

Series	Tube OD	PN	Dimensions									Weight (*9/105) ca. per 100 ²	Ordering Codes ³
	(mm/in)		(mm/in)	L	L ¹	L ²	L ³	S1	S2	S3			
L	6	500	4	16	24	9	26	14	14	14	4,63	FI-EVD-06L-B-W3-DKO	
	.24	7250	.16	.63	.94	.35	1.02	.55	.55	.55	10.19		
	8	500	6	19	27	12	27,5	14	17	17	4,72	FI-EVD-08L-B-W3-DKO	
	.31	7250	.24	.75	1.06	.47	1.08	.55	.67	.67	10.37		
	10	500	8	19	27	12	29	19	19	19	7,56	FI-EVD-10L-B-W3-DKO	
	.39	7250	.31	.75	1.06	.47	1.14	.75	.75	.75	16.63		
	12	400	10	21	29	14	29,5	19	22	22	8,66	FI-EVD-12L-B-W3-DKO	
	.47	5800	.39	.83	1.14	.55	1.16	.75	.87	.87	19.06		
	15	400	12	24	32	17	32,5	22	27	27	12,96	FI-EVD-15L-B-W3-DKO	
	.59	5800	.47	.94	1.26	.67	1.28	.87	1.06	1.06	28.52		
	18	400	15	24	33	17	35,5	27	32	32	20,64	FI-EVD-18L-B-W3-DKO	
	.71	5800	.59	.94	1.30	.67	1.40	1.06	1.26	1.26	45.42		
	22	400	19	26	35	19	38,5	30	36	36	26,41	FI-EVD-22L-B-W3-DKO	
	.87	5800	.75	1.02	1.38	.75	1.52	1.18	1.42	1.42	58.11		
	28	250	24	30,5	40	23	41,5	36	41	41	34,69	FI-EVD-28L-B-W3-DKO	
	1.10	3625	.94	1.20	1.57	.91	1.63	1.42	1.61	1.61	76.32		
	35	250	30	37	48	27	51	50	50	50	79,60	FI-EVD-35L-B-W3-DKO	
	1.38	3625	1.18	1.46	1.89	1.06	2.01	1.97	1.97	1.97	175.12		
42	250	36	37	49	26	56	50	60	60	83,20	FI-EVD-42L-B-W3-DKO		
1.65	3625	1.42	1.46	1.93	1.02	2.20	1.97	2.36	2.36	183.04			
S	6	800	4	16	24	9	27	14	17	17	4,90	FI-EVD-06S-B-W3-DKO	
	.24	11600	.16	.63	.94	.35	1.06	.55	.67	.67	10.77		
	8	800	5	19	27	12	27,5	19	19	19	5,17	FI-EVD-08S-B-W3-DKO	
	.31	11600	.20	.75	1.06	.47	1.08	.75	.75	.75	11.37		
	10	800	7	21	30	13	30	19	22	22	9,44	FI-EVD-10S-B-W3-DKO	
	.39	11600	.28	.83	1.18	.51	1.18	.75	.87	.87	20.76		
	12	630	8	24	33	17	31	19	24	24	12,90	FI-EVD-12S-B-W3-DKO	
	.47	9135	.31	.94	1.30	.67	1.22	.75	.94	.94	28.38		
	16	630	12	24	34	16	36,5	19	30	30	16,76	FI-EVD-16S-B-W3-DKO	
	.63	9135	.47	.94	1.34	.63	1.44	.75	1.18	1.18	36.87		
	20	400	16	26,5	37,5	16	44,5	27	36	36	30,72	FI-EVD-20S-B-W3-DKO	
	.79	5800	.63	1.04	1.48	.63	1.75	1.06	1.42	1.42	67.58		
	25	400	20	30,5	42,5	19	50	36	46	46	50,10	FI-EVD-25S-B-W3-DKO	
	.98	5800	.79	1.20	1.67	.75	1.97	1.42	1.81	1.81	110.22		
	30	400	25	37	50	24	55	50	50	50	92,90	FI-EVD-30S-B-W3-DKO	
1.18	5800	.98	1.46	1.97	.94	2.17	1.97	1.97	1.97	204.38			
38	400	32	37	52	21	63	50	60	60	98,50	FI-EVD-38S-B-W3-DKO		
1.50	5800	1.26	1.46	2.05	.83	2.48	1.97	2.36	2.36	216.70			

Ordering Codes
***FI-EVD*-10*L*-B*-W3*-DKO*-MS**

- * Adjustable Elbow (45°) with 24° Taper / O-Ring (DKO) FI-EVD
 - * Outside Tube Diameter D1 (in mm) -10
 - * Series L
S
 - Light Series
 - Heavy Series
 - * Seal Material -B
-V
-E
 - NBR (Buna-N®)
 - FKM (Viton®)
 - EPDM
 - * Material Code -W3
 - Steel, zinc/nickel-plated
- Please contact STAUFF for alternative materials and surface finishings.
- * Assembling / Kitting -DKO
-MS
-MSV
 - Fitting body supplied with swivel nut and O-ring
 - Fitting body supplied with cutting ring and union nut
 - Fitting body supplied with soft-sealing cutting ring and union nut

Connecting Parts

-  Cutting Ring
Type **FI-DS** Page 26
-  Soft-Sealing Cutting Ring
Type **FI-WDDS** Page 27
-  Support Sleeve
Type **FI-VH** Page 28
-  STAUFF Form Ring
Type **FI-AR** Page 30
-  Union Nut
Type **FI-M** Page 31
-  37° Flared Tube Fitting Set
Type **FI-AB** Page 35

Spare Parts / Accessories

-  O-Ring
Type **O-RING** Page 207

¹ Approximate dimension in assembled condition.
² Weight excluding cutting ring and union nut.
³ Standard scope of delivery: Fitting body only.



Typical application with a Straight Male Stud Fitting FI-GE-...

Standard seal material is NBR (Buna-N®).



Adjustable Branch Tee with 24° Taper / O-Ring (DKO)
Type FI-ETD ▪ Series L / S

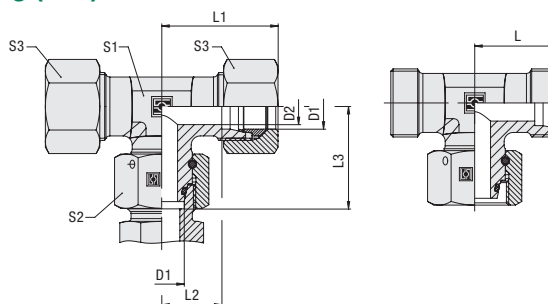

Ordering Codes

***FI-ETD*-10*L*-B*-W3*-DKO*-MS**

- * Adjustable Branch Tee with 24° Taper / O-Ring (DKO) **FI-ETD**
 - * Outside Tube Diameter D1 (in mm) **-10**
 - * Series **L** (Light Series) **S** (Heavy Series)
 - * Seal Material **-B** (NBR (Buna-N®)) **-V** (FKM (Viton®)) **-E** (EPDM)
 - * Material Code **-W3** (Steel, zinc/nickel-plated)
- Please contact STAUFF for alternative materials and surface finishings.
- * Assembling / Kitting **-DKO** (Fitting body supplied with swivel nut and O-ring)
 - MS** (Fitting body supplied with cutting ring and union nut)
 - MSV** (Fitting body supplied with soft-sealing cutting ring and union nut)

Connecting Parts

- Cutting Ring Type **FI-DS** Page 26
- Soft-Sealing Cutting Ring Type **FI-WDDS** Page 27
- Support Sleeve Type **FI-VH** Page 28
- STAUFF Form Ring Type **FI-AR** Page 30
- Union Nut Type **FI-M** Page 31
- 37° Flared Tube Fitting Set Type **FI-AB** Page 35

Spare Parts / Accessories

- O-Ring Type **O-RING** Page 207

Series	Tube OD	PN	Dimensions							Weight (^{kg} / _{lbs}) ca. per 100 ²	Ordering Codes ³	
	(^{mm} / _{in}) D1		(^{bar} / _{psi})	(^{mm} / _{in}) D2	L	L1 ¹	L2	L3	S1			S2
L	6	500	4	19	27	12	26	12	14	14	3,02	FI-ETD-06L-B-W3-DKO
	.24	7250	.16	.75	1.06	.47	1.02	.47	.55	.55	6,64	
	8	500	6	21	29	14	27,5	12	17	17	4,82	FI-ETD-08L-B-W3-DKO
	.31	7250	.24	.83	1.14	.55	1.08	.47	.67	.67	10,61	
	10	500	8	22	30	15	29	14	19	19	6,27	FI-ETD-10L-B-W3-DKO
	.39	7250	.31	.87	1.18	.59	1.14	.55	.75	.75	13,79	
	12	400	10	24	32	17	29,5	17	22	22	8,73	FI-ETD-12L-B-W3-DKO
	.47	5800	.39	.94	1.26	.67	1.16	.67	.87	.87	19,21	
	15	400	12	28	36	21	32,5	19	27	27	14,55	FI-ETD-15L-B-W3-DKO
	.59	5800	.47	1.10	1.42	.83	1.28	.75	1.06	1.06	32,01	
	18	400	15	31	40	23,5	35,5	24	32	32	20,89	FI-ETD-18L-B-W3-DKO
	.71	5800	.59	1.22	1.57	.93	1.40	.94	1.26	1.26	45,95	
	22	400	19	35	44	27,5	38,5	27	36	36	28,27	FI-ETD-22L-B-W3-DKO
	.87	5800	.75	1.38	1.73	1.08	1.52	1.06	1.42	1.42	62,20	
	28	250	24	38	47	30,5	41,5	36	41	41	39,85	FI-ETD-28L-B-W3-DKO
	1.10	3625	.94	1.50	1.85	1.20	1.63	1.42	1.61	1.61	87,67	
	35	250	30	45	56	34,5	51	41	50	50	64,20	FI-ETD-35L-B-W3-DKO
	1.38	3625	1.18	1.77	2.20	1.36	2.01	1.61	1.97	1.97	141,24	
42	250	36	51	63	40	56	50	60	60	94,90	FI-ETD-42L-B-W3-DKO	
1.65	3625	1.42	2.01	2.48	1.57	2.20	1.97	2.36	2.36	208,78		
S	6	800	4	23	31	16	27	12	17	17	5,99	FI-ETD-06S-B-W3-DKO
	.24	11600	.16	.91	1.22	.63	1.06	.47	.67	.67	13,18	
	8	800	5	24	32	17	27,5	14	19	19	7,80	FI-ETD-08S-B-W3-DKO
	.31	11600	.20	.94	1.26	.67	1.08	.55	.75	.75	17,15	
	10	800	7	25	34	17,5	30	17	22	22	10,60	FI-ETD-10S-B-W3-DKO
	.39	11600	.28	.98	1.34	.69	1.18	.67	.87	.87	23,32	
	12	630	8	29	38	21,5	31	17	24	24	13,63	FI-ETD-12S-B-W3-DKO
	.47	9135	.31	1.14	1.50	.85	1.22	.67	.94	.94	29,98	
	14	630	10	30	40	22	35	19	27	27	17,37	FI-ETD-14S-B-W3-DKO
	.55	9135	.39	1.18	1.57	.87	1.38	.75	1.06	1.06	38,21	
	16	630	12	33	43	24,5	36,5	24	30	30	22,95	FI-ETD-16S-B-W3-DKO
	.63	9135	.47	1.30	1.69	.96	1.44	.94	1.18	1.18	50,49	
	20	400	16	37	48	26,5	44,5	27	36	36	35,51	FI-ETD-20S-B-W3-DKO
	.79	5800	.63	1.46	1.89	1.04	1.75	1.06	1.42	1.42	78,13	
	25	400	20	42	54	30	50	36	46	46	62,40	FI-ETD-25S-B-W3-DKO
	.98	5800	.79	1.65	2.13	1.18	1.97	1.42	1.81	1.81	137,28	
	30	400	25	49	62	35,5	55	41	50	50	85,60	FI-ETD-30S-B-W3-DKO
	1.18	5800	.98	1.93	2.44	1.40	2.17	1.61	1.97	1.97	188,32	
38	400	32	57	72	41	63	50	60	60	128,10	FI-ETD-38S-B-W3-DKO	
1.50	5800	1.26	2.24	2.83	1.61	2.48	1.97	2.36	2.36	281,82		

¹ Approximate dimension in assembled condition.
² Weight excluding cutting ring and union nut.
³ Standard scope of delivery: Fitting body only.



Typical application with a Straight Male Stud Fitting FI-GE-...

Standard seal material is NBR (Buna-N®).



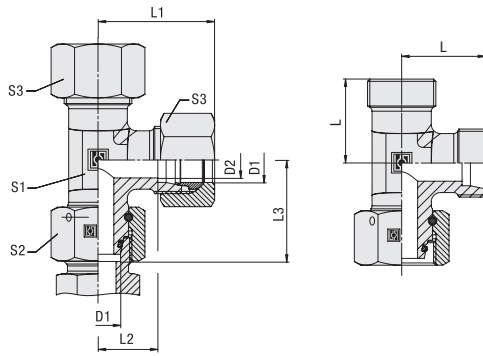

Adjustable Barrel Tee with 24° Taper / O-Ring (DKO)
Type FI-ELD • Series L / S



Series	Tube OD	PN (bar/PSI)	Dimensions (mm/in)									Weight (^{kg} /lbs) ca. per 100 ²	Ordering Codes ³
	D1		D2	L	L ¹	L ²	L ³	S1	S2	S3			
L	6	500	4	19	27	12	26	12	14	14	4,79	FI-ELD-06L-B-W3-DKO	
	.24	7250	.16	.75	1.06	.47	1.02	.47	.55	.55	10.53	FI-ELD-08L-B-W3-DKO	
	8	500	6	21	29	14	27,5	12	17	17	4,88		
	.31	7250	.24	.83	1.14	.55	1.08	.47	.67	.67	10.74	FI-ELD-10L-B-W3-DKO	
	10	500	8	22	30	15	29	14	19	19	6,45		
	.39	7250	.31	.87	1.18	.59	1.14	.55	.75	.75	14.19	FI-ELD-12L-B-W3-DKO	
	12	400	10	24	32	17	29,5	17	22	22	8,58		
	.47	5800	.39	.94	1.26	.67	1.16	.67	.87	.87	18.88	FI-ELD-15L-B-W3-DKO	
	15	400	12	28	36	21	32,5	19	27	27	14,60		
	.59	5800	.47	1.10	1.42	.83	1.28	.75	1.06	1.06	32.12	FI-ELD-18L-B-W3-DKO	
	18	400	15	31	40	23,5	35,5	24	32	32	20,83		
	.71	5800	.59	1.22	1.57	.93	1.40	.94	1.26	1.26	45.82	FI-ELD-22L-B-W3-DKO	
	22	400	19	35	44	27,5	38,5	27	36	36	28,02		
	.87	5800	.75	1.38	1.73	1.08	1.52	1.06	1.42	1.42	61.64	FI-ELD-28L-B-W3-DKO	
	28	250	24	38	47	30,5	41,5	36	41	41	39,66		
	1.10	3625	.94	1.50	1.85	1.20	1.63	1.42	1.61	1.61	87.25	FI-ELD-35L-B-W3-DKO	
	35	250	30	45	56	34,5	51	41	50	50	64,60		
	1.38	3625	1.18	1.77	2.20	1.36	2.01	1.61	1.97	1.97	142.12	FI-ELD-42L-B-W3-DKO	
42	250	36	51	63	40	56	50	60	60	94,70			
1.65	3625	1.42	2.01	2.48	1.57	2.20	1.97	2.36	2.36	208.34	FI-ELD-06S-B-W3-DKO		
S	6	800	4	23	31	16	27	12	17	17	6,04	FI-ELD-08S-B-W3-DKO	
	.24	11600	.16	.91	1.22	.63	1.06	.47	.67	.67	13.30	FI-ELD-10S-B-W3-DKO	
	8	800	5	24	32	17	27,5	14	19	19	8,14		
	.31	11600	.20	.94	1.26	.67	1.08	.55	.75	.75	17.90	FI-ELD-12S-B-W3-DKO	
	10	800	7	25	34	17,5	30	17	22	22	10,53		
	.39	11600	.28	.98	1.34	.69	1.18	.67	.87	.87	23.16	FI-ELD-14S-B-W3-DKO	
	12	630	8	29	38	21,5	31	17	24	24	13,80		
	.47	9135	.31	1.14	1.50	.85	1.22	.67	.94	.94	30.36	FI-ELD-16S-B-W3-DKO	
	14	630	10	30	40	22	35	19	27	27	20,27		
	.55	9135	.39	1.18	1.57	.87	1.38	.75	1.06	1.06	44.59	FI-ELD-20S-B-W3-DKO	
	16	630	12	33	43	24,5	36,5	24	30	30	23,13		
	.63	9135	.47	1.30	1.69	.96	1.44	.94	1.18	1.18	50.88	FI-ELD-25S-B-W3-DKO	
	20	400	16	37	48	26,5	44,5	27	36	36	35,53		
	.79	5800	.63	1.46	1.89	1.04	1.75	1.06	1.42	1.42	78.17	FI-ELD-30S-B-W3-DKO	
	25	400	20	42	54	30	50	36	46	46	61,90		
	.98	5800	.79	1.65	2.13	1.18	1.97	1.42	1.81	1.81	136.18	FI-ELD-38S-B-W3-DKO	
	30	400	25	49	62	35,5	55	41	50	50	85,10		
	1.18	5800	.98	1.93	2.44	1.40	2.17	1.61	1.97	1.97	187.22	FI-ELD-38S-B-W3-DKO	
38	400	32	57	72	41	63	50	60	60	128,00			
1.50	5800	1.26	2.24	2.83	1.61	2.48	1.97	2.36	2.36	281.60			

¹ Approximate dimension in assembled condition.
² Weight excluding cutting ring and union nut.
³ Standard scope of delivery: Fitting body only.



Typical application with a Straight Male Stud Fitting FI-GE...

Standard seal material is NBR (Buna-N®).

Ordering Codes

FI-ELD-10*L*-B*-W3*-DKO*-MS

- * Adjustable Barrel Tee with 24° Taper / O-Ring (DKO) FI-ELD
 - * Outside Tube Diameter D1 (in mm) -10
 - * Series L
S
 - Light Series
 - Heavy Series
 - * Seal Material -B
-V
-E
 - NBR (Buna-N®)
 - FKM (Viton®)
 - EPDM
 - * Material Code -W3
 - Steel, zinc/nickel-plated
- Please contact STAUFF for alternative materials and surface finishings.
- * Assembling / Kitting -DKO
-MS
-MSV
 - Fitting body supplied with swivel nut and O-ring
 - Fitting body supplied with cutting ring and union nut
 - Fitting body supplied with soft-sealing cutting ring and union nut

Connecting Parts







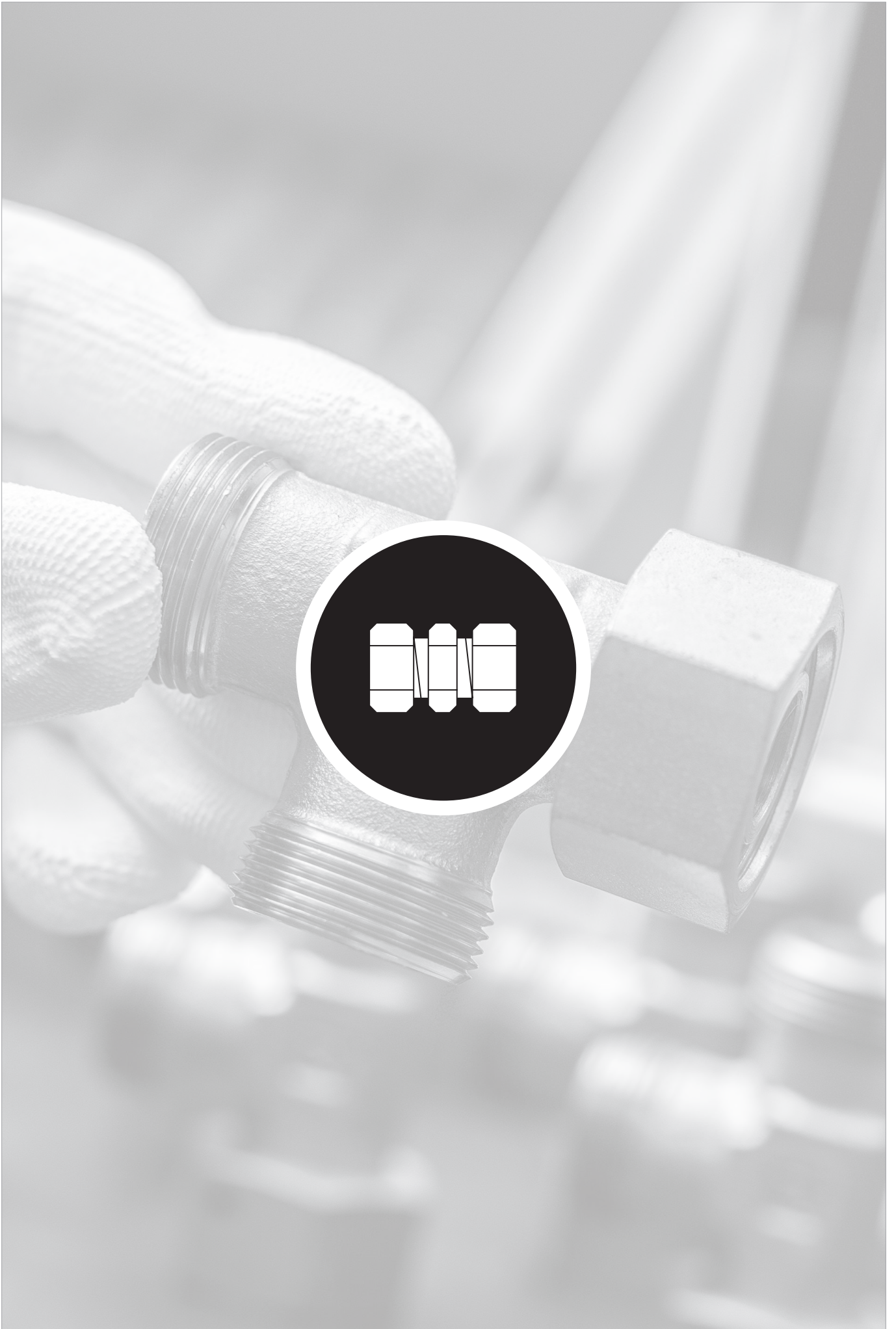

-  Cutting Ring
Type FI-DS Page 26
-  Soft-Sealing Cutting Ring
Type FI-WDDS Page 27
-  Support Sleeve
Type FI-VH Page 28
-  STAUFF Form Ring
Type FI-AR Page 30
-  Union Nut
Type FI-M Page 31
-  37° Flared Tube Fitting Set
Type FI-AB Page 35

Spare Parts / Accessories

-  O-Ring
Type O-RING Page 207





	Straight Male Stud Standpipe Fitting	132-136
	FI-EGE	
	Whitworth Parallel Pipe Thread (BSPP) / Metallic Sealing Edge	132
	FI-EGE-...-R	
	Metric Parallel Thread / Metallic Sealing Edge	133
	FI-EGE-...-M	
	Whitworth Parallel Pipe Thread (BSPP) / Profile Sealing Ring	134
	FI-EGE-...-R-WD	
	Metric Parallel Thread / Profile Sealing Ring	135
	FI-EGE-...-M-WD	
	NPT Thread	136
	FI-EGE-...-N	
	Straight Standpipe Reducer	138
	FI-REDS	
	Adjustable Standpipe Elbow	142
	FI-EW	
	Adjustable Standpipe Branch Tee	143
	FI-ET	
	Adjustable Standpipe Barrel Tee	144
	FI-EL	



Straight Male Stud Standpipe Fitting
Type FI-EGE-...-R • Series L / S

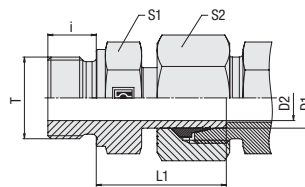

Ordering Codes

***FI-EGE*-10*L*R*-W3*-SV**

- * Straight Male Stud Standpipe Fitting **FI-EGE**
- * Outside Tube Diameter D1 (in mm) **-10**
- * Series **L**
 Light Series
S
 Heavy Series
- * Thread Type **R**
 Whitworth Parallel
 Pipe Thread (BSPP)
- If required, please indicate special sizes, e.g. R1/8!
- * Material Code **-W3**
 Steel, zinc/nickel-plated
- Please contact STAUFF for alternative materials and surface finishings.
- * Assembling / Kitting **-SV**
 Fitting body assembled with cutting ring and union nut on the standpipe

Whitworth Parallel Pipe Thread (BSPP)

Metallic Sealing Edge

Series	Tube OD (mm/in)	PN (PB) (bar/psi)	Dimensions (mm/in)						Torque (N·m/ft·lb)	Weight (kg/lbs) ca. per 100 ¹	Ordering Codes ²
			Thread T	D2	L1	i	S1	S2			
L	6	315	G 1/8	3,5	24,5	8	14	14	18	2,50	FI-EGE-06LR-W3-SV
	.24	4568		.14	.96	.31	.55	.55	13.3	5.50	
	8	315	G 1/4	4,5	29,5	12	19	17	35	5,53	FI-EGE-08LR-W3-SV
	.31	4568		.18	1.16	.47	.75	.67	25.9	12.17	
	10	315	G 1/4	7	27,5	12	19	19	35	5,11	FI-EGE-10LR-W3-SV
	.39	4568		.28	1.08	.47	.75	.75	25.9	11.23	
	12	315	G 3/8	7,5	34	12	22	22	70	8,25	FI-EGE-12LR-W3-SV
	.47	4568		.30	1.34	.47	.87	.87	51.8	18.15	
	15	315	G 1/2	11	32	14	27	27	110	13,02	FI-EGE-15LR-W3-SV
	.59	4568		.43	1.26	.55	1.06	1.06	81.4	28.65	
	18	315	G 1/2	14	31,5	14	27	32	110	13,86	FI-EGE-18LR-W3-SV
	.71	4568		.55	1.24	.55	1.06	1.26	81.4	30.48	
	22	160	G 3/4	18	32,5	16	32	36	180	19,98	FI-EGE-22LR-W3-SV
	.87	2320		.71	1.28	.63	1.26	1.42	133.2	43.96	
	28	160	G 1	23	35	18	41	41	330	27,39	FI-EGE-28LR-W3-SV
1.10	2320	.91		1.38	.71	1.61	1.61	244.2	60.26		
35	160	G 1 1/4	29,5	42,5	20	50	50	540	47,03	FI-EGE-35LR-W3-SV	
1.38	2320		1.16	1.67	.79	1.97	1.97	399.6	103.47		
42	160	G 1 1/2	35,5	46,5	22	55	60	630	72,00	FI-EGE-42LR-W3-SV	
1.65	2320		1.40	1.83	.87	2.17	2.36	466.2	158.40		
S	6	PB630	G 1/4	3,5	27	12	19	17	55	4,98	FI-EGE-06SR-W3-SV
	.24	PB9135		.14	1.06	.47	.75	.67	40.7	10.96	
	8	PB630	G 1/4	4,5	29,5	12	19	19	55	5,98	FI-EGE-08SR-W3-SV
	.31	PB9135		.18	1.16	.47	.75	.75	40.7	13.16	
	10	PB630	G 3/8	6,5	32	12	22	22	90	8,81	FI-EGE-10SR-W3-SV
	.39	PB9135		.26	1.26	.47	.87	.87	66.6	19.39	
	12	PB630	G 3/8	7,5	34	12	22	24	90	10,01	FI-EGE-12SR-W3-SV
	.47	PB9135		.30	1.34	.47	.87	.94	66.6	22.01	
	14	PB630	G 1/2	9,5	36,5	14	27	27	130	13,95	FI-EGE-14SR-W3-SV
	.55	PB9135		.37	1.44	.55	1.06	1.06	96.2	30.69	
	16	PB400	G 1/2	11,5	37	14	27	30	130	16,94	FI-EGE-16SR-W3-SV
	.63	PB5800		.45	1.46	.55	1.06	1.18	96.2	37.28	
	20	PB400	G 3/4	15,5	43	16	32	36	270	26,98	FI-EGE-20SR-W3-SV
	.79	PB5800		.61	1.69	.63	1.26	1.42	199.8	59.36	
	25	PB400	G 1	18	48	18	41	46	340	49,03	FI-EGE-25SR-W3-SV
.98	PB5800	.71		1.89	.71	1.61	1.81	251.6	107.87		
30	PB400	G 1 1/4	23,5	51	20	50	50	540	69,13	FI-EGE-30SR-W3-SV	
1.18	PB5800		.93	2.01	.79	1.97	1.97	399.6	152.08		
38	PB315	G 1 1/2	29	60	22	55	60	700	98,20	FI-EGE-38SR-W3-SV	
1.50	PB4568		1.14	2.36	.87	2.17	2.36	518.0	216.04		

¹Weight including cutting ring and union nut on the standpipe.

²Standard scope of delivery: Fitting body assembled with cutting ring and union nut on the standpipe.

Male stud acc. to DIN 3852-2 (Form B) / ISO 1179-4 (Type B)
 Port acc. to DIN 3852-2 (Form X) / ISO 1179-1

Torque recommendations for Steel mating material.

Please note: Standpipes are always factory-assembled with cutting rings and union nuts.

The union nut assembled on the standpipe has to be tightened by only 1/12 a turn (equivalent to 30°) beyond the fixed point.

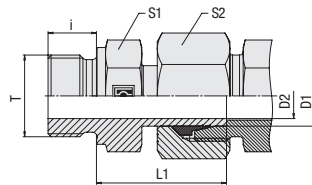

**Straight Male Stud Standpipe Fitting
Type FI-EGE-...-M • Series L / S**

Metallic Sealing Edge
Metric Parallel Thread

Series	Tube OD		PN (PB) Dimensions (mm/in)	Dimensions						Torque (N·m / ft·lb)	Weight (kg / lbs) ca. per 100 ¹	Ordering Codes ²
	(mm/in)	(bar/PSI)		Thread T	D2	L1	i	S1	S2			
L	6	315	M 10 x 1	3,5	24,5	8	14	14	18	2,54	FI-EGE-06LM-W3-SV	
	.24	4568		.14	.96	.31	.55	.55	13.3	5.59		
	8	315	M 12 x 1,5	5,5	26,5	12	17	17	30	4,34	FI-EGE-08LM-W3-SV	
	.31	4568		.22	1.04	.47	.67	.67	22.2	9.55		
	10	315	M 14 x 1,5	7	27,5	12	19	19	45	5,29	FI-EGE-10LM-W3-SV	
	.39	4568		.28	1.08	.47	.75	.75	33.3	11.63		
	12	315	M 16 x 1,5	9	30,5	12	22	22	65	7,95	FI-EGE-12LM-W3-SV	
	.47	4568		.35	1.24	.47	.87	.87	48.1	17.48		
	15	315	M 18 x 1,5	11	31,5	12	24	27	80	10,25	FI-EGE-15LM-W3-SV	
	.59	4568		.43	1.24	.47	.94	1.06	59.2	22.55		
	18	315	M 22 x 1,5	14	31,5	14	27	32	140	14,82	FI-EGE-18LM-W3-SV	
	.71	4568		.55	1.24	.55	1.06	1.26	103.6	32.60		
	22	160	M 26 x 1,5	18	32,5	16	32	36	190	19,57	FI-EGE-22LM-W3-SV	
	.87	2320		.71	1.28	.63	1.26	1.42	140.6	43.06		
	28	160	M 33 x 2	23	35	18	41	41	340	28,94	FI-EGE-28LM-W3-SV	
	1.10	2320		.91	1.38	.71	1.61	1.61	251.6	63.67		
	35	160	M 42 x 2	29,5	42,5	20	50	50	500	47,56	FI-EGE-35LM-W3-SV	
	1.38	2320		1.16	1.67	.79	1.97	1.97	370.0	104.63		
	42	160	M 48 x 2	35,5	46,5	22	55	60	630	67,00	FI-EGE-42LM-W3-SV	
	1.65	2320		1.40	1.83	.87	2.17	2.36	466.2	147.40		
S	6	PB630	M 12 x 1,5	3,5	27	12	17	17	35	4,51	FI-EGE-06SM-W3-SV	
	.24	PB9135		.14	1.06	.47	.67	.67	25.9	9.92		
	8	PB630	M 14 x 1,5	4,5	29,5	12	19	19	55	6,30	FI-EGE-08SM-W3-SV	
	.31	PB9135		.18	1.16	.47	.75	.75	40.7	13.85		
	10	PB630	M 16 x 1,5	6,5	32	12	22	22	70	8,79	FI-EGE-10SM-W3-SV	
	.39	PB9135		.26	1.26	.47	.87	.87	51.8	19.33		
	12	PB630	M 18 x 1,5	7,5	34	12	24	24	110	11,24	FI-EGE-12SM-W3-SV	
	.47	PB9135		.30	1.34	.47	.94	.94	81.4	24.73		
	14	PB630	M 20 x 1,5	9,5	36,5	14	27	27	150	15,53	FI-EGE-14SM-W3-SV	
	.55	PB9135		.37	1.44	.55	1.06	1.06	111.0	34.17		
	16	PB400	M 22 x 1,5	11,5	37	14	27	30	170	17,47	FI-EGE-16SM-W3-SV	
	.63	PB5800		.45	1.46	.55	1.06	1.18	125.8	38.43		
	20	PB400	M 27 x 2	15,5	43	16	32	36	270	27,28	FI-EGE-20SM-W3-SV	
	.79	PB5800		.61	1.69	.63	1.26	1.42	199.8	60.02		
	25	PB400	M 33 x 2	18	48	18	41	46	410	51,00	FI-EGE-25SM-W3-SV	
	.98	PB5800		.71	1.89	.71	1.61	1.81	303.4	112.20		
	30	PB400	M 42 x 2	23,5	51	20	50	50	540	69,54	FI-EGE-30SM-W3-SV	
	1.18	PB5800		.93	2.01	.79	1.97	1.97	399.6	152.98		
	38	PB315	M 48 x 2	29	60	22	55	60	700	99,38	FI-EGE-38SM-W3-SV	
	1.50	PB4568		1.14	2.36	.87	2.17	2.36	518.0	218.64		

Ordering Codes
***FI-EGE*-10*L*M*-W3*-SV**

- * Straight Male Stud Standpipe Fitting **FI-EGE**
- * Outside Tube Diameter D1 (in mm) **-10**
- * Series **L**
Light Series **L**
Heavy Series **S**
- * Thread Type **M**
Metric Parallel Thread **M**
- If required, please indicate special sizes, e.g. M12x1.5!
- * Material Code **-W3**
Steel, zinc/nickel-plated **-W3**
- Please contact STAUFF for alternative materials and surface finishings.
- * Assembling / Kitting **-SV**
Fitting body assembled with cutting ring and union nut on the standpipe **-SV**

¹ Weight including cutting ring and union nut on the standpipe.

Male stud acc. to DIN 3852-1 (Form B) / ISO 9974-3 (Type B)
Port acc. to DIN 3852-1 (Form X) / ISO 9974-1

² Standard scope of delivery: Fitting body assembled with cutting ring and union nut on the standpipe.

Torque recommendations for Steel mating material.

Please note: Standpipes are always factory-assembled with cutting rings and union nuts.



The union nut assembled on the standpipe has to be tightened by only 1/12 a turn (equivalent to 30°) beyond the fixed point.



Straight Male Stud Standpipe Fitting
Type FI-EGE-...-R-WD • Series L / S

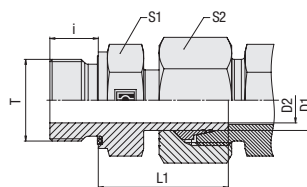

Whitworth Parallel Pipe Thread (BSPP)

Profile Sealing Ring

Ordering Codes

***FI-EGE*-10*L*R*-WD*-B*-W3*-SV**

- * Straight Male Stud Standpipe Fitting **FI-EGE**
- * Outside Tube Diameter D1 (in mm) **-10**
- * Series **L**
 Light Series
 Heavy Series **S**
- * Thread Type **R**
 Whitworth Parallel
 Pipe Thread (BSPP)
- If required, please indicate special sizes, e.g. R1/8!
- * Seal Type **-WD**
 Profile Sealing Ring
- * Seal Material **-B**
 NBR (Buna-N®)
-V
 FKM (Viton®)
-E
 EPDM
- * Material Code **-W3**
 Steel, zinc/nickel-plated
- Please contact STAUFF for alternative materials and surface finishings.
- * Assembling / Kitting **-SV**
 Fitting body assembled with
 cutting ring and union nut
 on the standpipe

Spare Parts / Accessories



Profile Sealing Ring
 Type **WDG**

Page 206

Series	Tube OD (mm/in)	PN (bar/psi)	Dimensions (mm/in)						Torque (N-m/ft-lb)	Weight (kg/lbs) ca. per 100 ¹	Ordering Codes ²
			Thread T	D2	L1	i	S1	S2			
L	6	315	G 1/8	3,5	24,5	8	14	14	18	2,29	FI-EGE-06LR-WD-B-W3-SV
	.24	4568		.14	.96	.31	.55	.55	13.3	5.04	
	8	315	G 1/4	4,5	29,5	12	19	17	35	4,43	FI-EGE-08LR-WD-B-W3-SV
	.31	4568		.18	1.16	.47	.75	.67	25.9	9.75	
	10	315	G 1/4	7	27,5	12	19	19	35	5,04	FI-EGE-10LR-WD-B-W3-SV
	.39	4568		.28	1.08	.47	.75	.75	25.9	11.09	
	12	315	G 3/8	7,5	34	12	22	22	70	9,23	FI-EGE-12LR-WD-B-W3-SV
	.47	4568		.30	1.34	.47	.87	.87	51.8	20.31	
	15	315	G 1/2	11	32	14	27	27	90	13,01	FI-EGE-15LR-WD-B-W3-SV
	.59	4568		.43	1.26	.55	1.06	1.06	66.6	28.62	
	18	315	G 1/2	14	31,5	14	27	27	90	13,89	FI-EGE-18LR-WD-B-W3-SV
	.71	4568		.55	1.24	.55	1.06	1.06	66.6	30.55	
	22	160	G 3/4	18	32,5	16	32	36	180	19,63	FI-EGE-22LR-WD-B-W3-SV
	.87	2320		.71	1.28	.63	1.26	1.42	133.2	43.19	
	28	160	G 1	23	35	18	41	41	310	28,64	FI-EGE-28LR-WD-B-W3-SV
	1.10	2320		.91	1.38	.71	1.61	1.61	229.4	63.02	
	35	160	G 1 1/4	29,5	42,5	20	50	50	450	46,03	FI-EGE-35LR-WD-B-W3-SV
	1.38	2320		1.16	1.67	.79	1.97	1.97	333.0	101.26	
42	160	G 1 1/2	35,5	46,5	22	55	60	540	69,40	FI-EGE-42LR-WD-B-W3-SV	
1.65	2320		1.40	1.83	.87	2.17	2.36	399.6	152.68		
S	6	630	G 1/4	3,5	27	12	19	17	55	4,95	FI-EGE-06SR-WD-B-W3-SV
	.24	9135		.14	1.06	.47	.75	.67	40.7	10.89	
	8	630	G 1/4	4,5	29,5	12	19	19	55	5,95	FI-EGE-08SR-WD-B-W3-SV
	.31	9135		.18	1.16	.47	.75	.75	40.7	13.09	
	10	630	G 3/8	6,5	32	12	22	22	80	8,71	FI-EGE-10SR-WD-B-W3-SV
	.39	9135		.26	1.26	.47	.87	.87	59.2	19.15	
	12	630	G 3/8	7,5	34	12	22	24	80	10,02	FI-EGE-12SR-WD-B-W3-SV
	.47	9135		.30	1.34	.47	.87	.94	59.2	22.05	
	14	630	G 1/2	9,5	36,5	14	27	27	115	15,40	FI-EGE-14SR-WD-B-W3-SV
	.55	9135		.37	1.44	.55	1.06	1.06	85.1	33.88	
	16	400	G 1/2	11,5	37	14	27	30	115	16,88	FI-EGE-16SR-WD-B-W3-SV
	.63	5800		.45	1.46	.55	1.06	1.18	85.1	37.13	
	20	400	G 3/4	15,5	43	16	32	36	180	26,88	FI-EGE-20SR-WD-B-W3-SV
	.79	5800		.61	1.69	.63	1.26	1.42	133.2	59.14	
	25	400	G 1	18	48	18	41	46	310	48,81	FI-EGE-25SR-WD-B-W3-SV
	.98	5800		.71	1.89	.71	1.61	1.81	229.4	107.38	
	30	400	G 1 1/4	23,5	51	20	50	50	450	62,10	FI-EGE-30SR-WD-B-W3-SV
	1.18	5800		.93	2.01	.79	1.97	1.97	333.0	202.62	
38	315	G 1 1/2	29	60	22	55	60	540	97,70	FI-EGE-38SR-WD-B-W3-SV	
1.50	4568		1.14	2.36	.87	2.17	2.36	399.6	214.94		

¹Weight including cutting ring and union nut on the standpipe.

²Standard scope of delivery: Fitting body assembled with cutting ring and union nut on the standpipe.

Male stud acc. to ISO 1179-2 (Type E)
 Port acc. to ISO 1179-1

Torque recommendations for Steel mating material.

Please note: Standpipes are always factory-assembled with cutting rings and union nuts.

The union nut assembled on the standpipe has to be tightened by only 1/12 a turn (equivalent to 30°) beyond the fixed point.



**Straight Male Stud Standpipe Fitting
Type FI-EGE-...-M-WD • Series L / S**

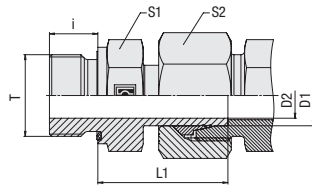

Profile Sealing Ring

Metric Parallel Thread

Series	Tube OD (mm/in)	PN (bar/PSI)	Dimensions (mm/in) Thread T	D2	L1	i	S1	S2	Torque (N·m/ft·lb) Thread T	Weight (kg/lbs) Ca. per 100 ¹	Ordering Codes ²
L	6	315	M 10 x 1	3,5	24,5	8	14	14	18	2,30	FI-EGE-06LM-WD-B-W3-SV
	.24	4568		.14	.96	.31	.55	.55	13.3	5,06	
	8	315	M 12 x 1,5	5,5	26,5	12	17	17	25	3,90	FI-EGE-08LM-WD-B-W3-SV
	.31	4568		.22	1.04	.47	.67	.67	18.5	8.58	
	10	315	M 14 x 1,5	7	27,5	12	19	19	45	4,99	FI-EGE-10LM-WD-B-W3-SV
	.39	4568		.28	1.08	.47	.75	.75	33.3	10.97	
	12	315	M 16 x 1,5	9	30,5	12	22	22	55	7,18	FI-EGE-12LM-WD-B-W3-SV
	.47	4568		.35	1.20	.47	.87	.87	40.7	15.79	
	15	315	M 18 x 1,5	11	31,5	12	24	27	70	10,25	FI-EGE-15LM-WD-B-W3-SV
	.59	4568		.43	1.24	.47	.94	1.06	51.8	22.55	
	18	315	M 22 x 1,5	14	31,5	14	27	32	125	13,62	FI-EGE-18LM-WD-B-W3-SV
	.71	4568		.55	1.24	.55	1.06	1.26	92.5	29.97	
	22	160	M 26 x 1,5	18	32,5	16	32	36	180	10,60	FI-EGE-22LM-WD-B-W3-SV
	.87	2320		.71	1.28	.63	1.26	1.42	133.2	23.32	
	28	160	M 33 x 2	23	35	18	41	41	310	30,26	FI-EGE-28LM-WD-B-W3-SV
	1.10	2320		.91	1.38	.71	1.61	1.61	229.4	66.57	
	35	160	M 42 x 2	29,5	42,5	20	50	50	450	47,17	FI-EGE-35LM-WD-B-W3-SV
	1.38	2320		1.16	1.67	.79	1.97	1.97	333.0	103.77	
	42	160	M 48 x 2	35,5	46,5	22	55	60	540	77,85	FI-EGE-42LM-WD-B-W3-SV
	1.65	2320		1.40	1.83	.87	2.17	2.36	399.6	171.26	
S	6	630	M 12 x 1,5	3,5	27	12	17	17	35	4,34	FI-EGE-06SM-WD-B-W3-SV
	.24	9135		.14	1.06	.47	.67	.67	25.9	9.54	
	8	630	M 14 x 1,5	4,5	29,5	12	19	19	55	5,90	FI-EGE-08SM-WD-B-W3-SV
	.31	9135		.18	1.16	.47	.75	.75	40.7	12.98	
	10	630	M 16 x 1,5	6,5	32	12	22	22	70	8,20	FI-EGE-10SM-WD-B-W3-SV
	.39	9135		.26	1.26	.47	.87	.87	51.8	18.04	
	12	630	M 18 x 1,5	7,5	34	12	24	24	90	10,97	FI-EGE-12SM-WD-B-W3-SV
	.47	9135		.30	1.34	.47	.94	.94	66.6	24.14	
	14	630	M 20 x 1,5	9,5	36,5	14	27	27	125	15,57	FI-EGE-14SM-WD-B-W3-SV
	.55	9135		.37	1.44	.55	1.06	1.06	92.5	34.25	
	16	630	M 22 x 1,5	11,5	37	14	27	30	135	16,20	FI-EGE-16SM-WD-B-W3-SV
	.63	9135		.45	1.46	.55	1.06	1.18	99.9	35.64	
	20	400	M 27 x 2	15,5	43	16	32	36	180	27,06	FI-EGE-20SM-WD-B-W3-SV
	.79	5800		.61	1.69	.63	1.26	1.42	133.2	59.54	
	25	400	M 33 x 2	18	48	18	41	46	310	48,60	FI-EGE-25SM-WD-B-W3-SV
	.98	5800		.71	1.89	.71	1.61	1.81	229.4	106.92	
	30	400	M 42 x 2	23,5	51	20	50	50	450	69,15	FI-EGE-30SM-WD-B-W3-SV
	1.18	5800		.93	2.01	.79	1.97	1.97	333.0	152.13	
	38	315	M 48 x 2	29	60	22	55	60	540	110,29	FI-EGE-38SM-WD-B-W3-SV
	1.50	4568		1.14	2.36	.87	2.17	2.36	399.6	242.65	

Ordering Codes

***FI-EGE*-10*L*M*-WD*-B*-W3*-SV**

- * Straight Male Stud Standpipe Fitting **FI-EGE**
- * Outside Tube Diameter D1 (in mm) **-10**
- * Series Light Series **L**
Heavy Series **S**
- * Thread Type Metric Parallel Thread **M**

If required, please indicate special sizes, e.g. M12x1.5!

- * Seal Type Profile Sealing Ring **-WD**
- * Seal Material NBR (Buna-N®) **-B**
FKM (Viton®) **-V**
EPDM **-E**
- * Material Code Steel, zinc/nickel-plated **-W3**

Please contact STAUFF for alternative materials and surface finishings.

- * Assembling / Kitting Fitting body assembled with cutting ring and union nut on the standpipe **-SV**

Spare Parts / Accessories

Profile Sealing Ring Type **WDG** Page 206

¹ Weight including cutting ring and union nut on the standpipe.

Male stud acc. to ISO 9974-2 (Type E)
Port acc. to ISO 9974-1

² Standard scope of delivery: Fitting body assembled with cutting ring and union nut on the standpipe.

Torque recommendations for Steel mating material.

Please note: Standpipes are always factory-assembled with cutting rings and union nuts.

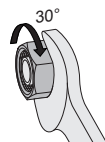

The union nut assembled on the standpipe has to be tightened by only 1/12 a turn (equivalent to 30°) beyond the fixed point.



Straight Male Stud Standpipe Fitting
Type FI-EGE-...-N • Series L / S

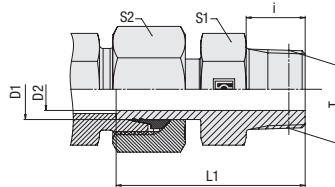

NPT Thread

Ordering Codes

***FI-EGE*-10*L*1/4*N*-W3*-SV**

- * Straight Male Stud Standpipe Fitting **FI-EGE**
- * Outside Tube Diameter D1 (in mm) **-10**
- * Series **L** Light Series
S Heavy Series
- * Thread Size **1/4** acc. to dimension table
Please always indicate thread sizes, e.g. 1/4!
- * Thread Type **N** NPT Thread
- * Material Code **-W3** Steel, zinc/nickel-plated
Please contact STAUFF for alternative materials and surface finishings.
- * Assembling / Kitting **-SV** Fitting body assembled with cutting ring and union nut on the standpipe

Series	Tube OD (mm/in) D1	PN (bar/psi) 4567,5	Dimensions (mm/in)						Weight (kg/lbs) ca. per 100 ¹	Ordering Codes ²
			Thread T	D2	L1	i	S1	S2		
L	6	315	1/8 NPT	3,3	33	10	11	14	2,27	FI-EGE-06L1/8N-W3-SV
	.24	4567,5		.13	1.30	.39	.43	.55	4.99	
	8	315	1/4 NPT	4	40	15,5	14	17	3,93	FI-EGE-08L1/4N-W3-SV
	.31	4567,5		.16	1.57	.61	.55	.67	8.64	
	10	315	1/4 NPT	6,5	41	15,5	14	19	4,46	FI-EGE-10L1/4N-W3-SV
	.39	4567,5		.26	1.61	.61	.55	.75	9.81	
	12	315	3/8 NPT	7	42	15,5	19	22	6,80	FI-EGE-12L3/8N-W3-SV
	.47	4567,5		.28	1.65	.61	.75	.87	14.97	
	15	315	1/2 NPT	10	46,5	20	22	27	10,48	FI-EGE-15L1/2N-W3-SV
	.59	4567,5		.39	1.83	.79	.87	1.06	23.05	
	18	315	1/2 NPT	13	49,5	20	22	32	13,44	FI-EGE-18L1/2N-W3-SV
	.71	4567,5		.51	1.95	.79	.87	1.26	29.56	
	22	160	3/4 NPT	16,5	49	20	27	36	18,41	FI-EGE-22L3/4N-W3-SV
	.87	2320		.65	1.93	.79	1.06	1.42	40.51	
	28	160	1 NPT	22	55,5	25	36	41	25,80	FI-EGE-28L1N-W3-SV
	1.10	2320		.87	2.19	.98	1.42	1.61	56.76	
	35	160	1 1/4 NPT	28	74,1	25,6	46	50	42,40	FI-EGE-35L1-1/4N-W3-SV
	1.38	2320		1.10	2.92	1.01	1.81	1.97	93.28	
42	160	1 1/2 NPT	34	78,5	26	50	60	62,33	FI-EGE-42L1-1/2N-W3-SV	
1.65	2320		1.34	3.09	1.02	1.97	2.36	137.13		
S	6	630	1/4 NPT	3	45,1	15,1	14	17	1,92	FI-EGE-06S1/4N-W3-SV
	.24	9135		.12	1.78	.59	.55	.67	4.23	
	8	630	1/4 NPT	4,3	40	15,5	14	19	4,45	FI-EGE-08S1/4N-W3-SV
	.31	9135		.17	1.57	.61	.55	.75	9.78	
	10	630	3/8 NPT	6	44,5	15,5	19	22	7,29	FI-EGE-10S3/8N-W3-SV
	.39	9135		.24	1.75	.61	.75	.87	16.04	
	12	630	3/8 NPT	7,3	46,5	15,5	19	24	8,49	FI-EGE-12S3/8N-W3-SV
	.47	9135		.29	1.83	.61	.75	.94	18.67	
	14	630	1/2 NPT	10,5	53,5	20	22	27	12,81	FI-EGE-14S1/2N-W3-SV
	.55	9135		.41	2.11	.79	.87	1.06	28.19	
	16	630	1/2 NPT	13,5	58	20	22	30	16,52	FI-EGE-16S1/2N-W3-SV
	.63	9135		.53	2.28	.79	.87	1.18	36.34	
	20	400	3/4 NPT	17,5	68	25	27	36	24,50	FI-EGE-20S3/4N-W3-SV
	.79	5800		.69	2.68	.98	1.06	1.42	53.90	
	25	400	1 NPT	17,5	68	25	36	46	41,13	FI-EGE-25S1N-W3-SV
	.98	5800		.69	2.68	.98	1.42	1.81	90.49	
	30	400	1 1/4 NPT	22	70,5	26	46	50	52,80	FI-EGE-30S1-1/4N-W3-SV
	1.18	5800		.87	2.78	1.02	1.81	1.97	116.16	
38	400	1 1/2 NPT	29	92	26	50	60	83,60	FI-EGE-38S1-1/2N-W3-SV	
1.50	5800		1.14	3.62	1.02	1.97	2.36	183.92		

¹ Weight including cutting ring and union nut on the standpipe.

² Standard scope of delivery: Fitting body assembled with cutting ring and union nut on the standpipe.

Male stud acc. to ANSI/ASME B1.20.1-1983
 Port acc. to ANSI/ASME B1.20.1-1983

Suitable liquid / plastic sealant required.

Please note: Standpipes are always factory-assembled with cutting rings and union nuts.

The union nut assembled on the standpipe has to be tightened by only 1/12 a turn (equivalent to 30°) beyond the fixed point.



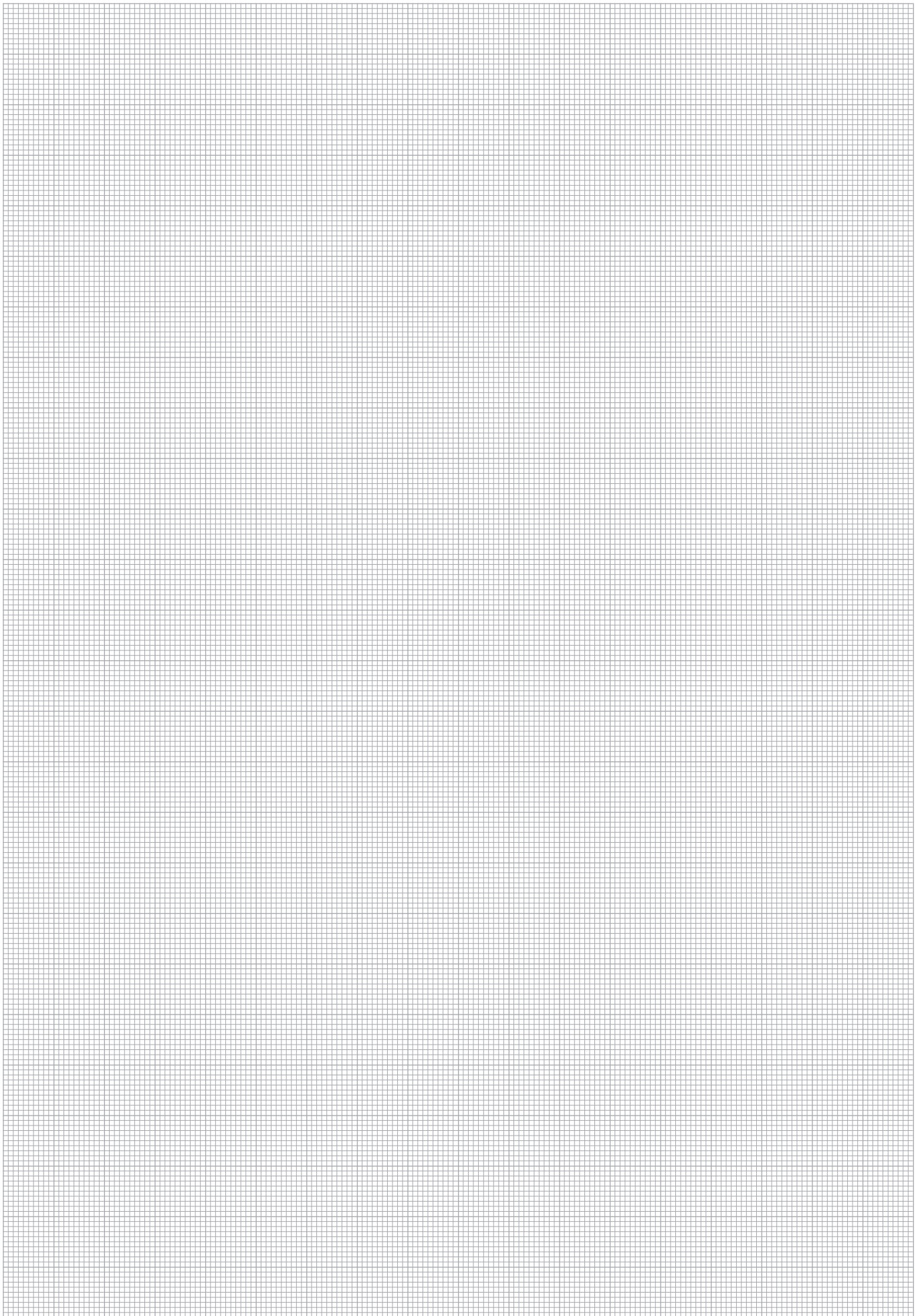

I



Straight Standpipe Reducer Type FI-REDS • Series L

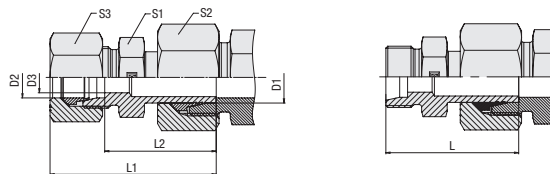

Ordering Codes

***FI-REDS*-10/*08*L*-W3*-SV-MS**

- * Straight Standpipe Reducer **FI-REDS**
 - * Outside Tube Diameter D1 (in mm) **-10**
 - * Outside Tube Diameter D2 (in mm) **08**
 - * Series **L**
S Light Series (pages 138/139)
S Heavy Series (pages 140/141)
 - * Material Code **-W3**
-SV Steel, zinc/nickel-plated
- Please contact STAUFF for alternative materials and surface finishings.
- * Assembling / Kitting **-SV**
-SV-MS Fitting body assembled with cutting ring and union nut on the standpipe
-SV-MS Fitting body assembled with cutting rings and union nuts on all ends

Connecting Parts

-  Cutting Ring
Type **FI-DS** Page 26
-  Soft-Sealing Cutting Ring
Type **FI-WDDS** Page 27
-  Support Sleeve
Type **FI-VH** Page 28
-  STAUFF Form Ring
Type **FI-AR** Page 30
-  Union Nut
Type **FI-M** Page 31
-  37° Flared Tube Fitting Set
Type **FI-AB** Page 35

Series	Tube OD (mm/in)		PN (bar/psi)	Dimensions (mm/in)							Weight (kg/lbs) ca. per 100 ²	Ordering Codes ³
	D1	D2		D3	L	L1 ¹	L2	S1	S2	S3		
L	8	6	500	4	33	40,5	27,5	12	17	14	3,15	FI-REDS-08/06L-W3-SV
	.31	.24	7250	.16	1.30	1.59	1.08	.47	.67	.55	6.93	
	10	6	500	4	34	41,5	28,5	12	19	14	4,00	FI-REDS-10/06L-W3-SV
	.39	.24	7250	.16	1.34	1.63	1.12	.47	.75	.55	8.79	
	10	8	500	6	35	42,5	28,5	14	19	17	3,97	FI-REDS-10/08L-W3-SV
	.39	.31	7250	.24	1.38	1.67	1.12	.55	.75	.67	8.74	
	12	6	400	4	37	44,5	28	14	22	14	4,75	FI-REDS-12/06L-W3-SV
	.47	.24	5800	.16	1.46	1.75	1.10	.55	.87	.55	10.44	
	12	8	400	6	36	44,5	29	14	22	17	5,35	FI-REDS-12/08L-W3-SV
	.47	.31	5800	.24	1.42	1.75	1.14	.55	.87	.67	11.78	
	12	10	400	8	37	45,5	30	17	22	19	5,48	FI-REDS-12/10L-W3-SV
	.47	.39	5800	.31	1.46	1.79	1.18	.67	.87	.75	12.05	
	15	6	400	4	38	46	28	17	27	14	7,53	FI-REDS-15/06L-W3-SV
	.59	.24	5800	.16	1.50	1.81	1.10	.67	1.06	.55	16.57	
	15	8	400	6	38	46	29	17	27	17	7,73	FI-REDS-15/08L-W3-SV
	.59	.31	5800	.24	1.50	1.81	1.14	.67	1.06	.67	17.01	
	15	10	400	8	37	47	30	17	27	19	8,24	FI-REDS-15/10L-W3-SV
	.59	.39	5800	.31	1.46	1.85	1.18	.67	1.06	.75	18.12	
	15	12	400	10	38	48	31	19	27	22	8,27	FI-REDS-15/12L-W3-SV
	.59	.47	5800	.39	1.50	1.89	1.22	.75	1.06	.87	18.19	
	18	6	400	4	37,5	45,5	30	19	32	14	10,36	FI-REDS-18/06L-W3-SV
	.71	.24	5800	.16	1.48	1.79	1.18	.75	1.26	.55	22.80	
	18	8	400	6	37,5	45,5	31	19	32	17	10,84	FI-REDS-18/08L-W3-SV
	.71	.31	5800	.24	1.48	1.79	1.22	.75	1.26	.67	23.85	
18	10	400	8	39	46,5	32	19	32	19	10,98	FI-REDS-18/10L-W3-SV	
.71	.39	5800	.31	1.54	1.83	1.26	.75	1.26	.75	24.16		
18	12	400	10	40,5	46,5	33,5	19	32	22	12,01	FI-REDS-18/12L-W3-SV	
.71	.47	5800	.39	1.59	1.83	1.32	.75	1.26	.87	26.43		
18	15	400	12	41	47,5	34	24	32	27	12,76	FI-REDS-18/15L-W3-SV	
.71	.59	5800	.47	1.61	1.87	1.34	.94	1.26	1.06	28.07		
22	6	250	4	39,5	47	32	24	36	14	13,75	FI-REDS-22/06L-W3-SV	
.87	.24	3625	.16	1.56	1.85	1.26	.94	1.42	.55	30.25		
22	8	250	6	43	46,5	34	24	36	17	19,87	FI-REDS-22/08L-W3-SV	
.87	.31	3625	.24	1.69	1.83	1.34	.94	1.42	.67	43.72		
22	10	250	8	41	47,5	34	24	36	19	15,17	FI-REDS-22/10L-W3-SV	
.87	.39	3625	.31	1.61	1.87	1.34	.94	1.42	.75	33.37		
22	12	250	10	39,5	47,5	34,5	24	36	22	15,45	FI-REDS-22/12L-W3-SV	
.87	.47	3625	.39	1.56	1.87	1.36	.94	1.42	.87	34.00		
22	15	250	12	40,5	48,5	36	24	36	27	16,02	FI-REDS-22/15L-W3-SV	
.87	.59	3625	.47	1.59	1.91	1.42	.94	1.42	1.06	35.24		
22	18	250	15	44	50,5	36,5	27	36	32	17,93	FI-REDS-22/18L-W3-SV	
.87	.71	3625	.59	1.73	1.99	1.44	1.06	1.42	1.26	39.45		

¹ Approximate dimension in assembled condition.

² Weight including cutting ring and union nut on the standpipe.

³ Standard scope of delivery: Fitting body assembled with cutting ring and union nut on the standpipe.

Please note: Standpipes are always factory-assembled with cutting rings and union nuts.

The union nut assembled on the standpipe has to be tightened by only 1/12 a turn (equivalent to 30°) beyond the fixed point.



Straight Standpipe Reducer
Type FI-REDS ■ Series L

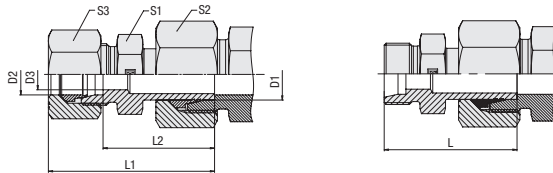

Series	Tube OD (mm/in)		PN (bar/psi)	Dimensions (mm/in)							Weight (^{kg} /lbs) ca. per 100 ²	Ordering Codes ³
	D1	D2		D3	L	L1 ¹	L2	S1	S2	S3		
L	28	6	250	4	41	49	34,5	30	41	14	18,12	FI-REDS-28/06L-W3-SV
	1.10	.24	3625	.16	1.61	1.93	1.36	1.18	1.61	.55	39.85	
L	28	8	250	6	42	50	34,5	30	41	17	18,24	FI-REDS-28/08L-W3-SV
	1.10	.31	3625	.24	1.65	1.97	1.36	1.18	1.61	.67	40.12	
L	28	10	250	8	41	49	35,5	30	41	19	18,45	FI-REDS-28/10L-W3-SV
	1.10	.39	3625	.31	1.61	1.93	1.40	1.18	1.61	.75	40.58	
L	28	12	250	10	41	49	35,5	30	41	22	19,79	FI-REDS-28/12L-W3-SV
	1.10	.47	3625	.39	1.61	1.93	1.40	1.18	1.61	.87	43.54	
L	28	15	250	12	42	50	36,5	30	41	27	20,30	FI-REDS-28/15L-W3-SV
	1.10	.59	3625	.47	1.65	1.97	1.44	1.18	1.61	1.06	44.66	
L	28	18	250	15	43,5	52	36	30	41	32	20,48	FI-REDS-28/18L-W3-SV
	1.10	.71	3625	.59	1.71	2.05	1.42	1.18	1.61	1.26	45.05	
L	28	22	250	19	45,5	54	38	32	41	36	23,25	FI-REDS-28/22L-W3-SV
	1.10	.87	3625	.75	1.79	2.13	1.50	1.26	1.61	1.42	51.14	
L	35	6	250	4	48	56	40,5	36	50	14	29,53	FI-REDS-35/06L-W3-SV
	1.38	.24	3625	.16	1.89	2.20	1.59	1.42	1.97	.55	64.97	
L	35	8	250	6	48	56	40,5	36	50	17	28,78	FI-REDS-35/08L-W3-SV
	1.38	.31	3625	.24	1.89	2.20	1.59	1.42	1.97	.67	63.32	
L	35	10	250	8	49	57	41,5	36	50	19	31,70	FI-REDS-35/10L-W3-SV
	1.38	.39	3625	.31	1.93	2.24	1.63	1.42	1.97	.75	69.74	
L	35	12	250	10	47	55	41,5	36	50	22	32,26	FI-REDS-35/12L-W3-SV
	1.38	.47	3625	.39	1.85	2.17	1.63	1.42	1.97	.87	70.97	
L	35	15	250	12	48,5	56,5	42,5	36	50	27	28,97	FI-REDS-35/15L-W3-SV
	1.38	.59	3625	.47	1.91	2.22	1.67	1.42	1.97	1.06	63.73	
L	35	18	250	15	49,5	58,5	42	36	50	32	32,20	FI-REDS-35/18L-W3-SV
	1.38	.71	3625	.59	1.95	2.30	1.65	1.42	1.97	1.26	70.83	
L	35	22	250	19	51,5	60,5	44	36	50	36	32,94	FI-REDS-35/22L-W3-SV
	1.38	.87	3625	.75	2.03	2.38	1.73	1.42	1.97	1.42	72.47	
L	35	28	250	24	52,5	61,5	44	41	50	41	34,18	FI-REDS-35/28L-W3-SV
	1.38	1.10	3625	.94	2.07	2.42	1.73	1.61	1.97	1.61	75.19	
L	42	10	250	8	51	59	45	46	60	19	45,84	FI-REDS-42/10L-W3-SV
	1.65	.39	3625	.31	2.01	2.32	1.77	1.81	2.36	.75	100.85	
L	42	12	250	10	52	60	45	46	60	22	56,37	FI-REDS-42/12L-W3-SV
	1.65	.47	3625	.39	2.05	2.36	1.77	1.81	2.36	.87	124.01	
L	42	15	250	12	52	60	46	46	60	27	58,28	FI-REDS-42/15L-W3-SV
	1.65	.59	3625	.47	2.05	2.36	1.81	1.81	2.36	1.06	115.06	
L	42	18	250	15	53	61	45,5	46	60	32	51,80	FI-REDS-42/18L-W3-SV
	1.65	.71	3625	.59	2.09	2.40	1.79	1.81	2.36	1.26	113.96	
L	42	22	250	19	54	63	47,5	46	60	36	58,28	FI-REDS-42/22L-W3-SV
	1.65	.87	3625	.75	2.13	2.48	1.87	1.81	2.36	1.42	128.22	
L	42	28	250	24	55	64	47,5	46	60	41	52,40	FI-REDS-42/28L-W3-SV
	1.65	1.10	3625	.94	2.17	2.52	1.87	1.81	2.36	1.61	115.28	
L	42	35	250	30	57	69	46,5	46	60	50	53,30	FI-REDS-42/35L-W3-SV
	1.65	1.38	3625	1.18	2.24	2.72	1.83	1.81	2.36	1.97	117.26	

Ordering Codes

FI-REDS-10/*08*L*-W3*-SV-MS

- * Straight Standpipe Reducer **FI-REDS**
- * Outside Tube Diameter D1 (in mm) **-10**
- * Outside Tube Diameter D2 (in mm) **08**
- * Series Light Series (pages 138/139) **L**
Heavy Series (pages 140/141) **S**
- * Material Code Steel, zinc/nickel-plated **-W3**

Please contact STAUFF for alternative materials and surface finishings.

- * Assembling / Kitting Fitting body assembled with cutting ring and union nut on the standpipe **-SV**
- Fitting body assembled with cutting rings and union nuts on all ends **-SV-MS**

Connecting Parts

- Cutting Ring Type **FI-DS** Page 26
- Soft-Sealing Cutting Ring Type **FI-WDDS** Page 27
- Support Sleeve Type **FI-VH** Page 28
- STAUFF Form Ring Type **FI-AR** Page 30
- Union Nut Type **FI-M** Page 31
- 37° Flared Tube Fitting Set Type **FI-AB** Page 35

¹ Approximate dimension in assembled condition.
² Weight including cutting ring and union nut on the standpipe.
³ Standard scope of delivery: Fitting body assembled with cutting ring and union nut on the standpipe.

Please note: Standpipes are always factory-assembled with cutting rings and union nuts.

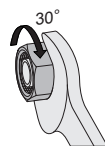

The union nut assembled on the standpipe has to be tightened by only 1/12 a turn (equivalent to 30°) beyond the fixed point.



Straight Standpipe Reducer Type FI-REDS • Series S

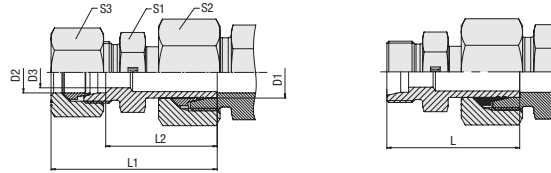

Ordering Codes

***FI-REDS*-10/*08*L*-W3*-SV-MS**

- * Straight Standpipe Reducer **FI-REDS**
- * Outside Tube Diameter D1 (in mm) **-10**
- * Outside Tube Diameter D2 (in mm) **08**
- * Series **L**
Light Series (pages 138/139)
S
Heavy Series (pages 140/141)
- * Material Code **-W3**
Steel, zinc/nickel-plated
- Please contact STAUFF for alternative materials and surface finishings.
- * Assembling / Kitting **-SV**
Fitting body assembled with cutting ring and union nut on the standpipe
- SV-MS**
Fitting body assembled with cutting rings and union nuts on all ends

Connecting Parts

-  Cutting Ring
Type **FI-DS** Page 26
-  Soft-Sealing Cutting Ring
Type **FI-WDDS** Page 27
-  Support Sleeve
Type **FI-VH** Page 28
-  STAUFF Form Ring
Type **FI-AR** Page 30
-  Union Nut
Type **FI-M** Page 31
-  37° Flared Tube Fitting Set
Type **FI-AB** Page 35

Series	Tube OD (mm/in)		PN (bar/psi)	Dimensions (mm/in)							Weight (kg/lbs) ca. per 100 ²	Ordering Codes ³
	D1	D2		D3	L	L1 ¹	L2	S1	S2	S3		
S	8	6	800	4	37	45	30	14	19	17	4,42	FI-REDS-08/06S-W3-SV
	.31	.24	11600	.16	1.46	1.77	1.18	.55	.75	.67	9.73	FI-REDS-10/06S-W3-SV
	10	6	800	4	39	47	34	14	22	17	6,26	FI-REDS-10/08S-W3-SV
	.39	.24	11600	.16	1.54	1.85	1.34	.55	.87	.67	13.78	FI-REDS-10/08S-W3-SV
	10	8	800	5	41	49	34	17	22	19	6,81	FI-REDS-12/06S-W3-SV
	.39	.31	11600	.20	1.61	1.93	1.34	.67	.87	.75	14.98	FI-REDS-12/06S-W3-SV
	12	6	630	4	39	47	36	14	24	17	6,70	FI-REDS-12/08S-W3-SV
	.47	.24	9135	.16	1.54	1.85	1.42	.55	.94	.67	14.74	FI-REDS-12/08S-W3-SV
	12	8	630	5	41	49	31,5	17	24	19	7,46	FI-REDS-12/10S-W3-SV
	.47	.31	9135	.20	1.61	1.93	1.24	.67	.94	.75	16.41	FI-REDS-12/10S-W3-SV
	12	10	630	7	41	50	36	19	24	22	7,80	FI-REDS-14/06S-W3-SV
	.47	.39	9135	.28	1.61	1.97	1.42	.75	.94	.87	17.16	FI-REDS-14/06S-W3-SV
	14	6	630	4	42	50	37	17	27	17	9,61	FI-REDS-14/08S-W3-SV
	.55	.24	9135	.16	1.65	1.97	1.46	.67	1.06	.67	21.15	FI-REDS-14/08S-W3-SV
	14	8	630	5	44	52	37	17	27	19	10,19	FI-REDS-14/10S-W3-SV
	.55	.31	9135	.20	1.73	2.05	1.46	.67	1.06	.75	22.42	FI-REDS-14/10S-W3-SV
	14	10	630	7	44	53	36,5	19	27	22	11,24	FI-REDS-14/12S-W3-SV
	.55	.39	9135	.28	1.73	2.09	1.44	.75	1.06	.87	24.72	FI-REDS-14/12S-W3-SV
	14	12	630	8	44	55	36,5	22	27	24	11,98	FI-REDS-16/06S-W3-SV
	.55	.47	9135	.31	1.73	2.17	1.44	.87	1.06	.94	26.36	FI-REDS-16/06S-W3-SV
	16	6	630	4	45,5	50	38,5	17	30	17	12,14	FI-REDS-16/08S-W3-SV
	.63	.24	9135	.16	1.79	1.97	1.52	.67	1.18	.67	26.71	FI-REDS-16/08S-W3-SV
	16	8	630	5	44	52	38,5	17	30	19	12,29	FI-REDS-16/10S-W3-SV
	.63	.31	9135	.20	1.73	2.05	1.52	.67	1.18	.75	27.03	FI-REDS-16/10S-W3-SV
16	10	630	7	44	53	38	19	30	22	12,78	FI-REDS-16/12S-W3-SV	
.63	.39	9135	.28	1.73	2.09	1.50	.75	1.18	.87	28.12	FI-REDS-16/12S-W3-SV	
16	12	630	8	46	55	38	22	30	24	14,39	FI-REDS-16/14S-W3-SV	
.63	.47	9135	.31	1.81	2.17	1.50	.87	1.18	.94	31.66	FI-REDS-16/14S-W3-SV	
16	14	630	10	47,5	58	39,5	24	30	27	14,70	FI-REDS-20/06S-W3-SV	
.63	.55	9135	.39	1.87	2.28	1.56	.94	1.18	1.06	32.34	FI-REDS-20/06S-W3-SV	
20	6	400	4	47	55	46,5	22	36	17	20,15	FI-REDS-20/08S-W3-SV	
.79	.24	5800	.16	1.85	2.17	1.83	.87	1.42	.67	44.33	FI-REDS-20/08S-W3-SV	
20	8	400	5	48	56	46,5	22	36	19	17,67	FI-REDS-20/10S-W3-SV	
.79	.31	5800	.20	1.89	2.20	1.83	.87	1.42	.75	38.88	FI-REDS-20/10S-W3-SV	
20	10	400	7	53,5	57	46	22	36	22	16,90	FI-REDS-20/12S-W3-SV	
.79	.39	5800	.28	2.11	2.24	1.81	.87	1.42	.87	37.18	FI-REDS-20/12S-W3-SV	
20	12	400	8	50	59	46	22	36	24	18,10	FI-REDS-20/14S-W3-SV	
.79	.47	5800	.31	1.97	2.32	1.81	.87	1.42	.94	39.82	FI-REDS-20/14S-W3-SV	
20	14	400	10	52	62	47,5	24	36	27	19,20	FI-REDS-20/16S-W3-SV	
.79	.55	5800	.39	2.05	2.44	1.87	.94	1.42	1.06	42.24	FI-REDS-20/16S-W3-SV	
20	16	400	12	55,5	62	47	27	36	30	23,31		
.79	.63	5800	.47	2.19	2.44	1.85	1.06	1.42	1.18	51.27		

¹ Approximate dimension in assembled condition.

² Weight including cutting ring and union nut on the standpipe.

³ Standard scope of delivery: Fitting body assembled with cutting ring and union nut on the standpipe.

Please note: Standpipes are always factory-assembled with cutting rings and union nuts.

The union nut assembled on the standpipe has to be tightened by only 1/12 a turn (equivalent to 30°) beyond the fixed point.



Straight Standpipe Reducer
Type FI-REDS ■ Series S

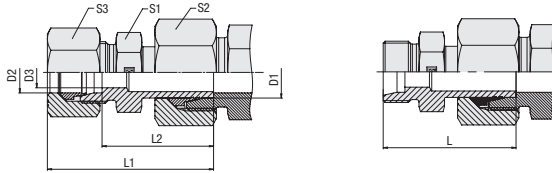

Series	Tube OD (mm/in)		PN (bar/psi)	Dimensions (mm/in)							Weight (kg/lbs) ca. per 100 ²	Ordering Codes ³
	D1	D2		D3	L	L1 ¹	L2	S1	S2	S3		
S	25	6	400	4	50	58	51	27	46	17	31,38	FI-REDS-25/06S-W3-SV
	.98	.24	5800	.16	1.97	2.28	2.01	1.06	1.81	.67	69.04	
25	8	400	5	51	59	51	27	46	19	31,65	FI-REDS-25/08S-W3-SV	
	.98	.31	5800	.20	2.01	2.32	2.01	1.06	1.81	.75		69.62
25	10	400	7	58	60	50,5	27	46	22	35,51	FI-REDS-25/10S-W3-SV	
	.98	.39	5800	.28	2.28	2.36	1.99	1.06	1.81	.87		78.12
25	12	400	8	53	62	50,5	27	46	24	38,88	FI-REDS-25/12S-W3-SV	
	.98	.47	5800	.31	2.09	2.44	1.99	1.06	1.81	.94		85.54
25	14	400	10	60	65	52	27	46	27	41,86	FI-REDS-25/14S-W3-SV	
	.98	.55	5800	.39	2.36	2.56	2.05	1.06	1.81	1.06		92.10
25	16	400	12	60	65	51,5	27	46	30	35,70	FI-REDS-25/16S-W3-SV	
	.98	.63	5800	.47	2.36	2.56	2.03	1.06	1.81	1.18		78.54
25	20	400	16	62	70	51,5	32	46	36	39,99	FI-REDS-25/20S-W3-SV	
	.98	.79	5800	.63	2.44	2.76	2.03	1.26	1.81	1.42		87.97
30	6	400	4	53	61	52,5	32	50	17	42,88	FI-REDS-30/06S-W3-SV	
	1.18	.24	5800	.16	2.09	2.40	2.07	1.26	1.97	.67		94.33
30	8	400	5	53	61	52,5	32	50	19	38,19	FI-REDS-30/08S-W3-SV	
	1.18	.31	5800	.20	2.09	2.40	2.07	1.26	1.97	.75		84.01
30	10	400	7	53	62	52	32	50	22	43,13	FI-REDS-30/10S-W3-SV	
	1.18	.39	5800	.28	2.09	2.44	2.05	1.26	1.97	.87		94.88
30	12	400	8	59,5	65	52	32	50	24	38,53	FI-REDS-30/12S-W3-SV	
	1.18	.47	5800	.31	2.34	2.56	2.05	1.26	1.97	.94		84.76
30	14	400	10	61,5	68	53,5	32	50	27	39,19	FI-REDS-30/14S-W3-SV	
	1.18	.55	5800	.39	2.42	2.68	2.11	1.26	1.97	1.06		86.23
30	16	400	12	61,5	68	53	32	50	30	43,00	FI-REDS-30/16S-W3-SV	
	1.18	.63	5800	.47	2.42	2.68	2.09	1.26	1.97	1.18		94.59
30	20	400	16	62	73	53	32	50	36	55,33	FI-REDS-30/20S-W3-SV	
	1.18	.79	5800	.63	2.44	2.87	2.09	1.26	1.97	1.42		121.72
30	25	400	20	66	78	53,5	41	50	46	52,60	FI-REDS-30/25S-W3-SV	
	1.18	.98	5800	.79	2.60	3.07	2.11	1.61	1.97	1.81		115.72
38	6	315	4	60	68	56	41	60	17	64,17	FI-REDS-38/06S-W3-SV	
	1.50	.24	4568	.16	2.36	2.68	2.20	1.61	2.36	.67		141.16
38	8	315	5	60	68	56	41	60	19	64,88	FI-REDS-38/08S-W3-SV	
	1.50	.31	4568	.20	2.36	2.68	2.20	1.61	2.36	.75		142.73
38	10	315	7	62	71	55,5	41	60	22	63,89	FI-REDS-38/10S-W3-SV	
	1.50	.39	4568	.28	2.44	2.80	2.19	1.61	2.36	.87		140.55
38	12	315	8	62	69	55,5	41	60	24	64,80	FI-REDS-38/12S-W3-SV	
	1.50	.47	4568	.31	2.44	2.72	2.19	1.61	2.36	.94		142.56
38	14	315	10	65	75	57	41	60	27	67,79	FI-REDS-38/14S-W3-SV	
	1.50	.55	4568	.39	2.56	2.95	2.24	1.61	2.36	1.06		149.14
38	16	315	12	65	74	56,5	41	60	30	64,60	FI-REDS-38/16S-W3-SV	
	1.50	.63	4568	.47	2.56	2.91	2.22	1.61	2.36	1.18		142.12
38	20	315	16	68	79	56,5	41	60	36	72,99	FI-REDS-38/20S-W3-SV	
	1.50	.79	4568	.63	2.68	3.11	2.22	1.61	2.36	1.42		160.57
38	25	315	20	69	84	57	41	60	46	66,80	FI-REDS-38/25S-W3-SV	
	1.50	.98	4568	.79	2.72	3.31	2.24	1.61	2.36	1.81		146.96
38	30	315	25	74	87	57,5	46	60	50	71,80	FI-REDS-38/30S-W3-SV	
	1.50	1.18	4568	.98	2.91	3.43	2.26	1.81	2.36	1.97		157.96

Ordering Codes

FI-REDS-10/*08*L*-W3*-SV-MS

- * Straight Standpipe Reducer **FI-REDS**
- * Outside Tube Diameter D1 (in mm) **-10**
- * Outside Tube Diameter D2 (in mm) **08**
- * Series Light Series (pages 138/139) **L**
Heavy Series (pages 140/141) **S**
- * Material Code Steel, zinc/nickel-plated **-W3**

Please contact STAUFF for alternative materials and surface finishings.

- * Assembling / Kitting Fitting body assembled with cutting ring and union nut on the standpipe **-SV**
- Fitting body assembled with cutting rings and union nuts on all ends **-SV-MS**

Connecting Parts

- Cutting Ring Type **FI-DS** Page 26
- Soft-Sealing Cutting Ring Type **FI-WDDS** Page 27
- Support Sleeve Type **FI-VH** Page 28
- STAUFF Form Ring Type **FI-AR** Page 30
- Union Nut Type **FI-M** Page 31
- 37° Flared Tube Fitting Set Type **FI-AB** Page 35

¹ Approximate dimension in assembled condition.
² Weight including cutting ring and union nut on the standpipe.
³ Standard scope of delivery: Fitting body assembled with cutting ring and union nut on the standpipe.

Please note: Standpipes are always factory-assembled with cutting rings and union nuts.

The union nut assembled on the standpipe has to be tightened by only 1/12 a turn (equivalent to 30°) beyond the fixed point.

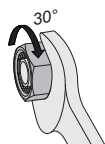

Adjustable Standpipe Elbow
Type FI-EW ▪ Series L / S

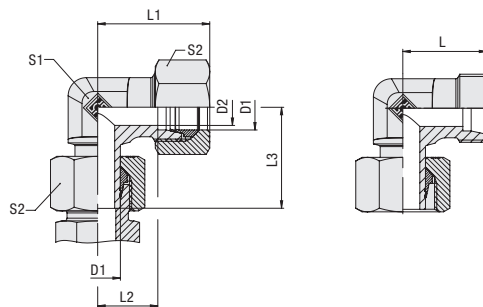

Ordering Codes

***FI-EW*-10*L*-W3*-SV-MS**

- * Adjustable Standpipe Elbow **FI-EW**
- * Outside Tube Diameter D1 (in mm) **-10**
- * Series **L**
Light Series
S
Heavy Series
- * Material Code **-W3**
Steel, zinc/nickel-plated
- Please contact STAUFF for alternative materials and surface finishings.
- * Assembling / Kitting **-SV**
Fitting body assembled with cutting ring and union nut on the standpipe
- SV-MS**
Fitting body assembled with cutting rings and union nuts on all ends

Connecting Parts

- Cutting Ring
Type **FI-DS** Page 26
- Soft-Sealing Cutting Ring
Type **FI-WDDS** Page 27
- Support Sleeve
Type **FI-VH** Page 28
- STAUFF Form Ring
Type **FI-AR** Page 30
- Union Nut
Type **FI-M** Page 31
- 37° Flared Tube Fitting Set
Type **FI-AB** Page 35

Series	Tube OD	PN	Dimensions							Weight (kg/lbs) ca. per 100 ²	Ordering Codes ³
	(mm/in) D1		(bar/psi)	(mm/in) D2	L	L1 ¹	L2	L3	S1		
L	6	315	4	19	27	12	26	12	14	2,89	FI-EW-06L-W3-SV
	.24	4568	.16	.75	1.06	.47	1.02	.47	.55	6,39	
	8	315	6	21	29	14	27,5	12	17	3,89	FI-EW-08L-W3-SV
	.31	4568	.24	.83	1.14	.55	1.08	.47	.67	8,56	
	10	315	8	22	30	15	29	14	19	5,20	FI-EW-10L-W3-SV
	.39	4568	.31	.87	1.18	.59	1.14	.55	.75	11,44	
	12	315	10	24	32	17	29,5	17	22	7,20	FI-EW-12L-W3-SV
	.47	4568	.39	.94	1.26	.67	1.16	.67	.87	15,84	
	15	315	12	28	36	21	32,5	19	27	17,20	FI-EW-15L-W3-SV
	.59	4568	.47	1.10	1.42	.83	1.28	.75	1.06	37,84	
	18	315	15	31	40	23,5	35,5	24	32	17,70	FI-EW-18L-W3-SV
	.71	4568	.59	1.22	1.57	.93	1.40	.94	1.26	38,94	
	22	160	19	35	44	27,5	38,5	27	36	24,00	FI-EW-22L-W3-SV
	.87	2320	.75	1.38	1.73	1.08	1.52	1.06	1.42	52,80	
	28	160	24	38	47	30,5	41,5	36	41	35,70	FI-EW-28L-W3-SV
	1.10	2320	.94	1.50	1.85	1.20	1.63	1.42	1.61	78,54	
	35	160	30	45	56	34,5	51	41	50	58,10	FI-EW-35L-W3-SV
	1.38	2320	1.18	1.77	2.20	1.36	2.01	1.61	1.97	127,82	
42	160	36	51	63	40	56	50	60	87,00	FI-EW-42L-W3-SV	
1.65	2320	1.42	2.01	2.48	1.57	2.20	1.97	2.36	191,40		
S	6	630	4	23	31	16	27	12	17	4,60	FI-EW-06S-W3-SV
	.24	9135	.16	.91	1.22	.63	1.06	.47	.67	10,12	
	8	630	5	24	32	17	27,5	14	19	6,20	FI-EW-08S-W3-SV
	.31	9135	.20	.94	1.26	.67	1.08	.55	.75	13,64	
	10	630	7	25	34	17,5	30	17	22	8,80	FI-EW-10S-W3-SV
	.39	9135	.28	.98	1.34	.69	1.18	.67	.87	19,36	
	12	630	8	29	38	21,5	31	17	24	10,90	FI-EW-12S-W3-SV
	.47	9135	.31	1.14	1.50	.85	1.22	.67	.94	23,98	
	14	400	10	30	40	22	35	19	27	14,90	FI-EW-14S-W3-SV
	.55	5800	.39	1.18	1.57	.87	1.38	.75	1.06	32,78	
	16	400	12	33	43	24,5	36,5	24	30	20,10	FI-EW-16S-W3-SV
	.63	5800	.47	1.30	1.69	.96	1.44	.94	1.18	44,22	
	20	400	16	37	48	26,5	44,5	27	36	30,60	FI-EW-20S-W3-SV
	.79	5800	.63	1.46	1.89	1.04	1.75	1.06	1.42	67,32	
	25	400	20	42	54	30	50	36	46	55,40	FI-EW-25S-W3-SV
	.98	5800	.79	1.65	2.13	1.18	1.97	1.42	1.81	121,88	
	30	400	25	49	62	35,5	55	41	50	79,80	FI-EW-30S-W3-SV
	1.18	5800	.98	1.93	2.44	1.40	2.17	1.61	1.97	175,56	
38	315	32	57	72	41	63	50	60	110,30	FI-EW-38S-W3-SV	
1.50	4568	1.26	2.24	2.83	1.61	2.48	1.97	2.36	242,66		

¹ Approximate dimension in assembled condition.

² Weight including cutting ring and union nut on the standpipe.

³ Standard scope of delivery: Fitting body assembled with cutting ring and union nut on the standpipe.



Typical application with a Straight Male Stud Fitting FI-GE-...

Please note: Standpipes are always factory-assembled with cutting rings and union nuts.



The union nut assembled on the standpipe has to be tightened by only 1/12 a turn (equivalent to 30°) beyond the fixed point.



Adjustable Standpipe Branch Tee Type FI-ET ■ Series L / S

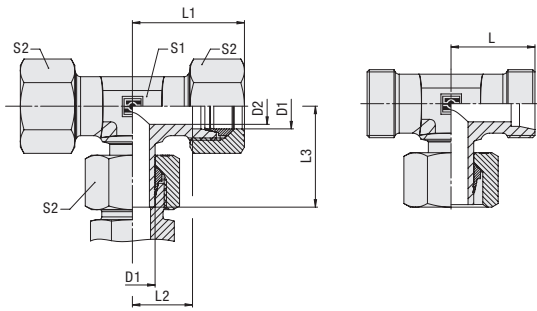

Series	Tube OD		Dimensions							Weight (^{kg} / _{lbs}) ca. per 100 ²	Ordering Codes ³
	(mm/in)	PN (bar/PSI)	D1	D2	L	L1 ¹	L2	L3	S1		
L	6	315	4	19	27	12	26	12	14	3,60	FI-ET-06L-W3-SV
	.24	4568	.16	.75	1.06	.47	1.02	.47	.55	7.92	
	8	315	6	21	29	14	27,5	12	17	4,70	FI-ET-08L-W3-SV
	.31	4568	.24	.83	1.14	.55	1.08	.47	.67	10.34	
	10	315	8	22	30	15	29	14	19	6,10	FI-ET-10L-W3-SV
	.39	4568	.31	.87	1.18	.59	1.14	.55	.75	13.42	
	12	315	10	24	32	17	29,5	17	22	8,30	FI-ET-12L-W3-SV
	.47	4568	.39	.94	1.26	.67	1.16	.67	.87	18.26	
	15	315	12	28	36	21	32,5	19	27	14,40	FI-ET-15L-W3-SV
	.59	4568	.47	1.10	1.42	.83	1.28	.75	1.06	31.68	
	18	315	15	31	40	23,5	35,5	24	32	20,70	FI-ET-18L-W3-SV
	.71	4568	.59	1.22	1.57	.93	1.40	.94	1.26	45.45	
	22	160	19	35	44	27,5	38,5	27	36	29,30	FI-ET-22L-W3-SV
	.87	2320	.75	1.38	1.73	1.08	1.52	1.06	1.42	64.46	
	28	160	24	38	47	30,5	41,5	36	41	40,80	FI-ET-28L-W3-SV
	1.10	2320	.94	1.50	1.85	1.20	1.63	1.42	1.61	89.76	
	35	160	30	45	56	34,5	51	41	50	65,00	FI-ET-35L-W3-SV
	1.38	2320	1.18	1.77	2.20	1.36	2.01	1.61	1.97	143.00	
42	160	36	51	63	40	56	50	60	87,90	FI-ET-42L-W3-SV	
1.65	2320	1.42	2.01	2.48	1.57	2.20	1.97	2.36	193.38		
S	6	630	4	23	31	16	27	12	17	5,80	FI-ET-06S-W3-SV
	.24	9135	.16	.91	1.22	.63	1.06	.47	.67	12.76	
	8	630	5	24	32	17	27,5	14	19	7,80	FI-ET-08S-W3-SV
	.31	9135	.20	.94	1.26	.67	1.08	.55	.75	17.16	
	10	630	7	25	34	17,5	30	17	22	10,20	FI-ET-10S-W3-SV
	.39	9135	.28	.98	1.34	.69	1.18	.67	.87	22.44	
	12	630	8	29	38	21,5	31	17	24	13,50	FI-ET-12S-W3-SV
	.47	9135	.31	1.14	1.50	.85	1.22	.67	.94	29.70	
	14	400	10	30	40	22	35	19	27	17,70	FI-ET-14S-W3-SV
	.55	5800	.39	1.18	1.57	.87	1.38	.75	1.06	38.94	
	16	400	12	33	43	24,5	36,5	24	30	23,70	FI-ET-16S-W3-SV
	.63	5800	.47	1.30	1.69	.96	1.44	.94	1.18	52.14	
	20	400	16	37	48	26,5	44,5	27	36	36,50	FI-ET-20S-W3-SV
	.79	5800	.63	1.46	1.89	1.04	1.75	1.06	1.42	80.30	
	25	400	20	42	54	30	50	36	46	63,70	FI-ET-25S-W3-SV
	.98	5800	.79	1.65	2.13	1.18	1.97	1.42	1.81	140.14	
	30	400	25	49	62	35,5	55	41	50	88,90	FI-ET-30S-W3-SV
	1.18	5800	.98	1.93	2.44	1.40	2.17	1.61	1.97	195.58	
38	315	32	57	72	41	63	50	60	135,80	FI-ET-38S-W3-SV	
1.50	4568	1.26	2.24	2.83	1.61	2.48	1.97	2.36	298.76		

Ordering Codes

***FI-ET*-10*L*-W3*-SV-MS**

- * Adjustable Standpipe Branch Tee **FI-ET**
- * Outside Tube Diameter D1 (in mm) **-10**
- * Series **L**
Light Series
S
Heavy Series
- * Material Code **-W3**
Steel, zinc/nickel-plated
- Please contact STAUFF for alternative materials and surface finishings.
- * Assembling / Kitting **-SV**
Fitting body assembled with cutting ring and union nut on the standpipe
- SV-MS**
Fitting body assembled with cutting rings and union nuts on all ends

Connecting Parts

- Cutting Ring
Type **FI-DS** Page 26
- Soft-Sealing Cutting Ring
Type **FI-WDDS** Page 27
- Support Sleeve
Type **FI-VH** Page 28
- STAUFF Form Ring
Type **FI-AR** Page 30
- Union Nut
Type **FI-M** Page 31
- 37° Flared Tube Fitting Set
Type **FI-AB** Page 35

¹ Approximate dimension in assembled condition.

² Weight including cutting ring and union nut on the standpipe.

³ Standard scope of delivery: Fitting body assembled with cutting ring and union nut on the standpipe.



Typical application with a Straight Male Stud Fitting FI-GE-...

Please note: Standpipes are always factory-assembled with cutting rings and union nuts.

The union nut assembled on the standpipe has to be tightened by only 1/12 a turn (equivalent to 30°) beyond the fixed point.



Adjustable Standpipe Barrel Tee Type FI-EL ▪ Series L / S

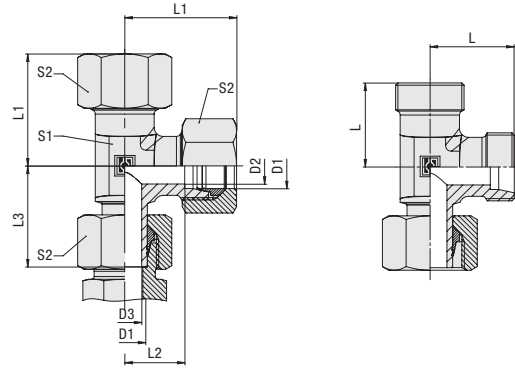

Ordering Codes

***FI-EL*-10*L*-W3*-SV-MS**

- * Adjustable Standpipe Barrel Tee **FI-EL**
- * Outside Tube Diameter D1 (in mm) **-10**
- * Series Light Series **L**
Heavy Series **S**
- * Material Code Steel, zinc/nickel-plated **-W3**
- Please contact STAUFF for alternative materials and surface finishings.
- * Assembling / Kitting Fitting body assembled with cutting ring and union nut on the standpipe **-SV**
Fitting body assembled with cutting rings and union nuts on all ends **-SV-MS**

Connecting Parts

-  Cutting Ring Type **FI-DS** Page 26
-  Soft-Sealing Cutting Ring Type **FI-WDDS** Page 27
-  Support Sleeve Type **FI-VH** Page 28
-  STAUFF Form Ring Type **FI-AR** Page 30
-  Union Nut Type **FI-M** Page 31
-  37° Flared Tube Fitting Set Type **FI-AB** Page 35

Series	Tube OD	PN	Dimensions								Weight (kg/lbs) ca. per 100 ²	Ordering Codes ³
	(mm/in) D1		(bar/psi)	(mm/in) D2	L	L1 ¹	L2	L3	S1	S2		
L	6	315	4	L	L11	L2	L3	S1	S2	3,60	FI-EL-06L-W3-SV	
	.24	4568	.16	19	27	12	26	12	14	7,92		
	8	315	6	.75	1.06	.47	1.02	.47	.55	4,70	FI-EL-08L-W3-SV	
	.31	4568	.24	21	29	14	27,5	12	17	10,34		
	10	315	8	.83	1.14	.55	1.08	.47	.67	6,10	FI-EL-10L-W3-SV	
	.39	4568	.31	22	30	15	29	14	19	13,42		
	12	315	10	.87	1.18	.59	1.14	.55	.75	8,30	FI-EL-12L-W3-SV	
	.47	4568	.39	24	32	17	29,5	17	22	18,26		
	15	315	12	.94	1.26	.67	1.16	.67	.87	14,40	FI-EL-15L-W3-SV	
	.59	4568	.47	28	36	21	32,5	19	27	31,68		
	18	315	15	1.10	1.42	.83	1.28	.75	1.06	20,70	FI-EL-18L-W3-SV	
	.71	4568	.59	31	40	23,5	35,5	24	32	45,45		
	22	160	19	1.22	1.57	.93	1.40	.94	1.26	29,30	FI-EL-22L-W3-SV	
	.87	2320	.75	35	44	27,5	38,5	27	36	64,46		
	28	160	24	1.38	1.73	1.08	1.52	1.06	1.42	40,80	FI-EL-28L-W3-SV	
	1.10	2320	.94	38	47	30,5	41,5	36	41	89,76		
	35	160	30	1.50	1.85	1.20	1.63	1.42	1.61	65,00	FI-EL-35L-W3-SV	
	1.38	2320	1.18	45	56	34,5	51	41	50	143,00		
42	160	36	1.77	2.20	1.36	2.01	1.61	1.97	87,90	FI-EL-42L-W3-SV		
1.65	2320	1.42	51	63	40	56	50	60	193,38			
S	6	630	4	2.01	2.48	1.57	2.20	1.97	2.36	5,80	FI-EL-06S-W3-SV	
	.24	9135	.16	23	31	16	27	12	17	12,76		
	8	630	5	.91	1.22	.63	1.06	.47	.67	7,80	FI-EL-08S-W3-SV	
	.31	9135	.20	24	32	17	27,5	14	19	17,16		
	10	630	7	.94	1.26	.67	1.08	.55	.75	10,20	FI-EL-10S-W3-SV	
	.39	9135	.28	25	34	17,5	30	17	22	22,44		
	12	630	8	.98	1.34	.69	1.18	.67	.87	13,50	FI-EL-12S-W3-SV	
	.47	9135	.31	29	38	21,5	31	17	24	29,70		
	14	400	10	1.14	1.50	.85	1.22	.67	.94	17,70	FI-EL-14S-W3-SV	
	.55	5800	.39	30	40	22	35	19	27	38,94		
	16	400	12	1.18	1.57	.87	1.38	.75	1.06	23,70	FI-EL-16S-W3-SV	
	.63	5800	.47	33	43	24,5	36,5	24	30	52,14		
	20	400	16	1.30	1.69	.96	1.44	.94	1.18	36,50	FI-EL-20S-W3-SV	
	.79	5800	.63	37	48	26,5	44,5	27	36	80,30		
	25	400	20	1.46	1.89	1.04	1.75	1.06	1.42	63,70	FI-EL-25S-W3-SV	
	.98	5800	.79	42	54	30	50	36	46	140,14		
	30	400	25	1.65	2.13	1.18	1.97	1.42	1.81	88,90	FI-EL-30S-W3-SV	
	1.18	5800	.98	49	62	35,5	55	41	50	195,58		
38	315	32	1.93	2.44	1.40	2.17	1.61	1.97	135,80	FI-EL-38S-W3-SV		
1.50	4568	1.26	57	72	41	63	50	60	298,76			

¹ Approximate dimension in assembled condition.

² Weight including cutting ring and union nut on the standpipe.

³ Standard scope of delivery: Fitting body assembled with cutting ring and union nut on the standpipe.



Typical application with a Straight Male Stud Fitting FI-GE-...

Please note: Standpipes are always factory-assembled with cutting rings and union nuts.



The union nut assembled on the standpipe has to be tightened by only 1/12 a turn (equivalent to 30°) beyond the fixed point.



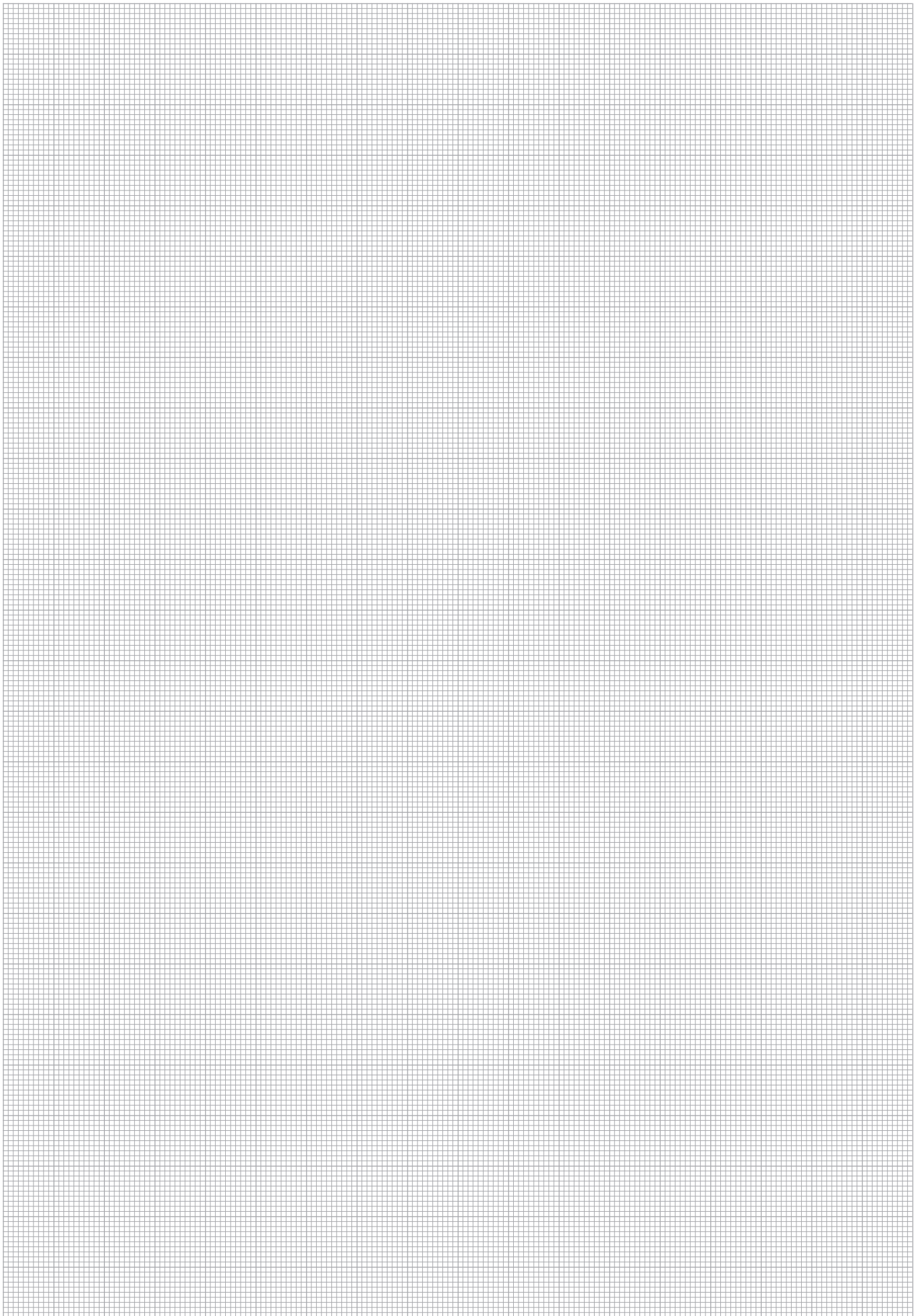

I





Adjustable Male Stud Elbow (90°) with Lock Nut

FI-WEE

**Whitworth Parallel Pipe Thread (BSPP) /
O-Ring and Retaining Ring (Small)**
FI-WEE-...-R-OK

148

**Metric Parallel Thread /
O-Ring and Retaining Ring (Small)**
FI-WEE-...-M-OK

150

**Metric Parallel Thread /
O-Ring**
FI-WEE-...-M-OR

152

**UN/UNF Thread /
O-Ring**
FI-WEE-...-U-OR

154

Adjustable Male Stud Elbow (45°) with Lock Nut

FI-VEE

**Whitworth Parallel Pipe Thread (BSPP) /
O-Ring and Retaining Ring (Small)**
FI-VEE-...-R-OK

149

**Metric Parallel Thread /
O-Ring and Retaining Ring (Small)**
FI-VEE-...-M-OK

151

**Metric Parallel Thread /
O-Ring**
FI-VEE-...-M-OR

153

**UN/UNF Thread /
O-Ring**
FI-VEE-...-U-OR

155

Adjustable Male Stud Branch Tee with Lock Nut

FI-TEE

**Whitworth Parallel Pipe Thread (BSPP) /
O-Ring and Retaining Ring (Small)**
FI-TEE-...-R-OK

149

**Metric Parallel Thread /
O-Ring and Retaining Ring (Small)**
FI-TEE-...-M-OK

151

**Metric Parallel Thread /
O-Ring**
FI-TEE-...-M-OR

153

**UN/UNF Thread /
O-Ring**
FI-TEE-...-U-OR

155

Adjustable Male Stud Barrel Tee with Lock Nut

FI-LEE

**Whitworth Parallel Pipe Thread (BSPP) /
O-Ring and Retaining Ring (Small)**
FI-LEE-...-R-OK

149

**Metric Parallel Thread /
O-Ring and Retaining Ring (Small)**
FI-LEE-...-M-OK

151

**Metric Parallel Thread /
O-Ring**
FI-LEE-...-M-OR

153

**UN/UNF Thread /
O-Ring**
FI-LEE-...-U-OR

155

J

Adjustable Male Stud Elbow (90°) with Lock Nut
Type FI-WEE-...-R-OK • Series L / S

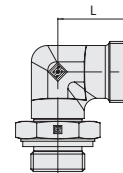
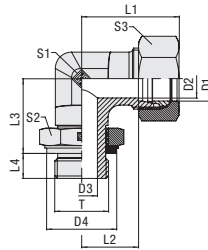

Whitworth Parallel Pipe Thread (BSP)

O-Ring and Retaining Ring (Small)

Series	Tube OD (mm/in)	PN (bar/PSI)	Dimensions (mm/in)													Torque (Nm/ft-lb)	Weight (kg/lbs) ca.	Ordering Codes ³
			Thread T	D2	D3	D4	L	L1 ¹	L2	L3	L4	S1	S2	S3	Thread T			
L	6	315	G 1/8	4	4	14,8	21	29	14	20	7	14	14	14	25	4,06	FI-WEE-06LR-OK-B-W3	
	.24	4568		.16	.16	.58	.83	1.14	.55	.79	.28	.55	.55	.55	18.5	8.94		
	8	315	G 1/4	6	5	19,8	23	31	16	25	9	14	19	17	50	6,34	FI-WEE-08LR-OK-B-W3	
	.31	4568		.24	.20	.78	.91	1.22	.63	.98	.35	.55	.75	.67	37.0	13.95		
	10	315	G 1/4	8	5	19,8	24	32	17	27	9	19	19	19	50	9,17	FI-WEE-10LR-OK-B-W3	
	.39	4568		.31	.20	.78	.94	1.26	.67	1.06	.35	.75	.75	.75	37.0	20.18		
	12	250	G 3/8	10	8	22,8	26	34	19	28	9	19	22	22	80	10,39	FI-WEE-12LR-OK-B-W3	
	.47	3625		.39	.31	.90	1.02	1.34	.75	1.10	.35	.75	.87	.87	59.2	22.87		
	15	250	G 1/2	12	12	27,8	28	36	21	29	13	22	27	27	105	15,73	FI-WEE-15LR-OK-B-W3	
	.59	3625		.47	.47	1.09	1.10	1.42	.83	1.14	.51	.87	1.06	1.06	77.7	34.61		
	18	250	G 1/2	15	12	27,8	31	40	23,5	33	13	27	27	32	105	22,29	FI-WEE-18LR-OK-B-W3	
	.71	3625		.59	.47	1.09	1.22	1.57	.93	1.30	.51	1.06	1.06	1.26	77.7	49.04		
	22	160	G 3/4	19	16	32,8	35	44	27,5	38	13	30	36	36	220	33,01	FI-WEE-22LR-OK-B-W3	
	.87	2320		.75	.63	1.29	1.38	1.73	1.08	1.50	.51	1.18	1.42	1.42	162.8	72.63		
28	160	G 1	24	20	40,8	38	47	30,5	44	15	36	41	41	370	50,60	FI-WEE-28LR-OK-B-W3		
1.10	2320		.94	.79	1.61	1.50	1.85	1.20	1.73	.59	1.42	1.61	1.61	273.8	111.32			
35	160	G 1 1/4	30	25	50,8	48	59	37,5	55	15	50	50	50	500	115,30	FI-WEE-35LR-OK-B-W3		
1.38	2320		1.18	.98	2.00	1.89	2.32	1.48	2.17	.59	1.97	1.97	1.97	370.0	253.66			
42	160	G 1 1/2	36	32	55,8	49	61	38	59	15	50	55	60	600	112,50	FI-WEE-42LR-OK-B-W3		
1.65	2320		1.42	1.26	2.20	1.93	2.40	1.50	2.32	.59	1.97	2.17	2.36	444.0	247.50			
S	6	315	G 1/4	4	5	19,8	22	30	15	25	9	14	19	17	50	6,62	FI-WEE-06SR-OK-B-W3	
	.24	4568		.16	.20	.78	.87	1.18	.59	.98	.35	.55	.75	.67	37.0	14.56		
	8	315	G 1/4	5	5	19,8	24	32	17	27	9	19	19	19	50	9,70	FI-WEE-08SR-OK-B-W3	
	.31	4568		.20	.20	.78	.94	1.26	.67	1.06	.35	.75	.75	.75	37.0	21.34		
	10	250	G 3/8	7	8	22,8	25	34	17,5	28	9	19	22	22	80	10,96	FI-WEE-10SR-OK-B-W3	
	.39	3625		.28	.31	.90	.98	1.34	.69	1.10	.35	.75	.87	.87	59.2	24.12		
	12	250	G 3/8	8	8	22,8	29	38	21,5	31	9	22	22	24	80	14,98	FI-WEE-12SR-OK-B-W3	
	.47	3625		.31	.31	.90	1.14	1.50	.85	1.22	.35	.87	.87	.94	59.2	32.95		
	16	250	G 1/2	12	12	27,8	33	43	24,5	33	13	27	27	30	105	23,56	FI-WEE-16SR-OK-B-W3	
	.63	3625		.47	.47	1.09	1.30	1.69	.96	1.30	.51	1.06	1.06	1.18	77.7	51.84		
	20	250	G 3/4	16	16	32,8	38	49	27,5	39	12	30	36	36	220	36,41	FI-WEE-20SR-OK-B-W3	
	.79	3625		.63	.63	1.29	1.50	1.93	1.08	1.54	.47	1.18	1.42	1.42	162.8	80.09		
	25	250	G 1	20	20	40,8	42	54	30	45	14	36	41	46	370	56,20	FI-WEE-25SR-OK-B-W3	
	.98	3625		.79	.79	1.61	1.65	2.13	1.18	1.77	.55	1.42	1.61	1.81	273.8	123.64		
30	160	G 1 1/4	25	25	50,8	49	62	35,5	55	15	50	50	50	500	120,20	FI-WEE-30SR-OK-B-W3		
1.18	2320		.98	.98	2.00	1.93	2.44	1.40	2.17	.59	1.97	1.97	1.97	370.0	264.44			
38	160	G 1 1/2	32	32	55,8	50	65	34	59	15	50	55	60	600	120,30	FI-WEE-38SR-OK-B-W3		
1.50	2320		1.26	1.26	2.20	1.97	2.56	1.34	2.32	.59	1.97	2.17	2.36	444.0	264.66			

¹ Approximate dimension in assembled condition.

² Weight excluding cutting ring and union nut.

³ Standard scope of delivery: Fitting body only.

Male stud acc. to ISO 1179-3 (Type H)

Port acc. to ISO 1179-1

Torque recommendations for Steel mating material.

Standard seal material is NBR (Buna-N®).

Ordering Codes

***FI-WEE*-10*L*R*-OK*-B*-W3*-MS**

- * Adjustable Male Stud Elbow (90°) with Lock Nut **FI-WEE**
- * Outside Tube Diameter (in mm) **-10**
- * Series **L** Light Series
S Heavy Series
- * Thread Type **R** Whitworth Parallel Pipe Thread (BSP)

- * Seal Type **-OK** O-Ring and Retaining Ring (Small)
- * Seal Material **-B** NBR (Buna-N®)
-V FKM (Viton®)
-E EPDM
- * Material Code **-W3** Steel, zinc/nickel-plated

- * Assembling / Kitting **---** Fitting body only
- MS** Fitting body supplied with cutting ring and union nut
- MSV** Fitting body supplied with soft-sealing cutting ring and union nut

If required, please indicate special sizes, e.g. R1/8!

Please contact STAUFF for alternative materials and surface finishings.



**Adjustable Male Stud Elbow (45°) with Lock Nut
Type FI-VEE-...-R-OK • Series L / S**
**Adjustable Male Stud Branch Tee with Lock Nut
Type FI-TEE-...-R-OK • Series L / S**
**Adjustable Male Stud Barrel Tee with Lock Nut
Type FI-LEE-...-R-OK • Series L / S**
Type FI-VEE-...-R-OK

Whitworth Parallel Pipe Thread (BSPP)
O-Ring and Retaining Ring (Small)

Male stud acc. to ISO 1179-3 (Type H)
Port acc. to ISO 1179-1

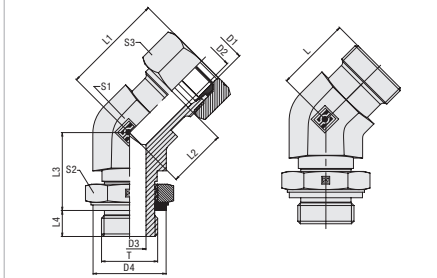

Dimensions L, L1, L2 and L3 deviating from the dimension table on the left.

Type FI-TEE-...-R-OK

Whitworth Parallel Pipe Thread (BSPP)
O-Ring and Retaining Ring (Small)

Male stud acc. to ISO 1179-3 (Type H)
Port acc. to ISO 1179-1

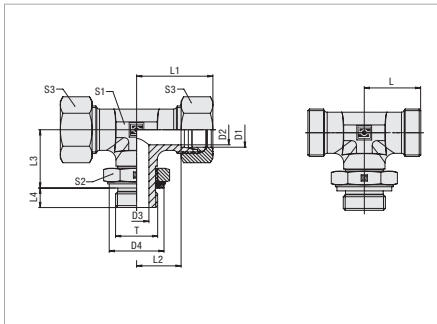
Type FI-LEE-...-R-OK

Whitworth Parallel Pipe Thread (BSPP)
O-Ring and Retaining Ring (Small)

Male stud acc. to ISO 1179-3 (Type H)
Port acc. to ISO 1179-1

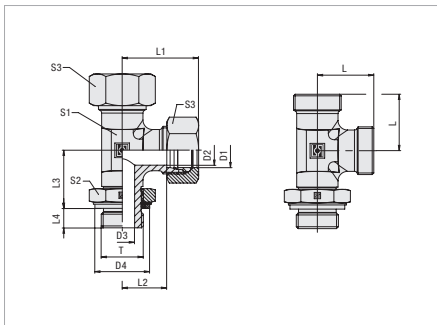
Connecting Parts

Cutting Ring
Type **FI-DS** Page 26



Soft-Sealing Cutting Ring
Type **FI-WDDS** Page 27



Support Sleeve
Type **FI-VH** Page 28



STAUFF Form Ring
Type **FI-AR** Page 30



Union Nut
Type **FI-M** Page 31



37° Flared Tube Fitting Set
Type **FI-AB** Page 35

Spare Parts / Accessories



O-Ring
Type **O-RING** Page 207



Retaining Ring (Small)
Type **FI-KR** Page 215

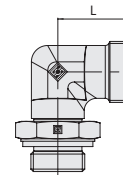
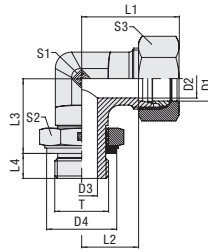

Adjustable Male Stud Elbow (90°) with Lock Nut
Type FI-WEE-...-M-OK • Series L / S



Metric Parallel Thread

O-Ring and Retaining Ring (Small)

Series	Tube OD		PN (bar/PSI)	Dimensions (mm/in)											Torque (Nm/ft-lb)	Weight (kg/lbs) ca. per 100 ²	Ordering Codes ³	
	D1	D2		Thread	T	D2	D3	D4	L	L1 ¹	L2	L3	L4	S1				S2
L	6	315	M 10 x 1	4	4	14,8	21	29	14	20	7	14	14	14	14	18	4,42	FI-WEE-06LM-OK-B-W3
	.24	4568		.16	.16	.58	.83	1.14	.55	.79	.28	.55	.55	.55	.55	13.3	9.72	
	8	315	M 12 x 1,5	6	4	17,8	23	31	16	23,5	10	14	17	17	35	5,14	FI-WEE-08LM-OK-B-W3	
	.31	4568		.24	.16	.70	.91	1.22	.63	.93	.39	.55	.67	.67	.67	25.9		11.31
	10	315	M 14 x 1,5	8	5	19,8	24	32	17	27	10	19	19	19	55	8,60	FI-WEE-10LM-OK-B-W3	
	.39	4568		.31	.20	.78	.94	1.26	.67	1.06	.39	.75	.75	.75	40.7	18.92		
	12	315	M 16 x 1,5	10	7	22,8	26	34	19	27	10	19	22	22	80	10,44	FI-WEE-12LM-OK-B-W3	
	.47	4568		.39	.28	.90	1.02	1.34	.75	1.06	.39	.75	.87	.87	59.2	22.96		
	15	315	M 18 x 1,5	12	8	24,8	28	36	21	29	11	22	24	27	105	14,89	FI-WEE-15LM-OK-B-W3	
	.59	4568		.47	.31	.98	1.10	1.42	.83	1.14	.43	.87	.94	1.06	77.7	32.75		
	18	250	M 22 x 1,5	15	12	27,8	31	40	23,5	36	12	27	27	32	125	23,93	FI-WEE-18LM-OK-B-W3	
	.71	3625		.59	.47	1.09	1.22	1.57	.93	1.42	.47	1.06	1.06	1.26	92.5	52.65		
	22	160	M 27 x 2	19	16	32,8	35	44	27,5	38	14	30	32	36	220	30,36	FI-WEE-22LM-OK-B-W3	
	.87	2320		.75	.63	1.29	1.38	1.73	1.08	1.50	.55	1.18	1.26	1.42	162.8	66.79		
	28	160	M 33 x 2	24	20	40,8	38	47	30,5	47	14	36	41	41	370	51,70	FI-WEE-28LM-OK-B-W3	
	1.10	2320		.94	.79	1.61	1.50	1.85	1.20	1.85	.55	1.42	1.61	1.61	273.8	113.74		
	35	160	M 42 x 2	30	25	50,8	48	59	37,5	58	14	50	50	50	500	106,10	FI-WEE-35LM-OK-B-W3	
	1.38	2320		1.18	.98	2.00	1.89	2.32	1.48	2.28	.55	1.97	1.97	1.97	370.0	233.42		
42	160	M 48 x 2	36	32	55,8	49	61	38	58,5	16	50	55	60	600	101,60	FI-WEE-42LM-OK-B-W3		
1.65	2320		1.42	1.26	2.20	1.93	2.40	1.50	2.30	.63	1.97	2.17	2.36	444.0	223.52			
S	6	315	M 12 x 1,5	4	4	17,8	22	30	15	23,5	10	14	17	17	35	6,43	FI-WEE-06SM-OK-B-W3	
	.24	4568		.16	.16	.70	.87	1.18	.59	.93	.39	.55	.67	.67	25.9	14.14		
	8	315	M 14 x 1,5	5	5	19,8	24	32	17	27	10	19	19	55	9,06	FI-WEE-08SM-OK-B-W3		
	.31	4568		.20	.20	.78	.94	1.26	.67	1.06	.39	.75	.75	.75	40.7		19.94	
	10	315	M 16 x 1,5	7	7	22,8	25	34	17,5	26	11	19	22	80	11,02	FI-WEE-10SM-OK-B-W3		
	.39	4568		.28	.28	.90	.98	1.34	.69	1.02	.43	.75	.87	.87	59.2		24.24	
	12	315	M 18 x 1,5	8	8	24,8	29	38	21,5	28	12	22	24	24	105	15,90	FI-WEE-12SM-OK-B-W3	
	.47	4568		.31	.31	.98	1.14	1.50	.85	1.10	.47	.87	.94	.94	77.7	34.98		
	16	250	M 22 x 1,5	12	12	27,8	33	43	24,5	34	14	27	27	30	125	25,14	FI-WEE-16SM-OK-B-W3	
	.63	3625		.47	.47	1.09	1.30	1.69	.96	1.34	.55	1.06	1.06	1.18	92.5	55.31		
	20	250	M 27 x 2	16	16	32,8	38	49	27,5	36	16	30	32	36	220	38,45	FI-WEE-20SM-OK-B-W3	
	.79	3625		.63	.63	1.29	1.50	1.93	1.08	1.42	.63	1.18	1.26	1.42	162.8	84.59		
	25	160	M 33 x 2	20	20	40,8	42	54	30	45	16	36	41	46	370	53,82	FI-WEE-25SM-OK-B-W3	
	.98	2320		.79	.79	1.61	1.65	2.13	1.18	1.77	.63	1.42	1.61	1.81	273.8	118.40		
	30	160	M 42 x 2	25	25	50,8	49	62	35,5	55	17	50	50	50	500	110,10	FI-WEE-30SM-OK-B-W3	
1.18	2320	.98		.98	2.00	1.93	2.44	1.40	2.17	.67	1.97	1.97	1.97	370.0	242.22			
38	160	M 48 x 2	32	32	55,8	50	65	34	55,5	19	50	55	60	600	109,30	FI-WEE-38SM-OK-B-W3		
1.50	2320		1.26	1.26	2.20	1.97	2.56	1.34	2.19	.75	1.97	2.17	2.36	444.0	240.46			

¹ Approximate dimension in assembled condition.

² Weight excluding cutting ring and union nut.

³ Standard scope of delivery: Fitting body only.

Port acc. to ISO 9974-1

Torque recommendations for Steel mating material.

Standard seal material is NBR (Buna-N®).

Ordering Codes

***FI-WEE*-10*L*M*-OK*-B*-W3*-MS**

- * Adjustable Male Stud Elbow (90°) with Lock Nut **FI-WEE**
- * Outside Tube Diameter (in mm) **-10**
- * Series Light Series **L**
Heavy Series **S**
- * Thread Type Metric Parallel Thread **M**

If required, please indicate special sizes, e.g. M26x1.5!

- * Seal Type O-Ring and Retaining Ring (Small) **-OK**
- * Seal Material NBR (Buna-N®) **-B**
FKM (Viton®) **-V**
EPDM **-E**
- * Material Code Steel, zinc/nickel-plated **-W3**

Please contact STAUFF for alternative materials and surface finishings.

- * Assembling / Kitting Fitting body only **—**
- Fitting body supplied with cutting ring and union nut **-MS**
- Fitting body supplied with soft-sealing cutting ring and union nut **-MSV**



**Adjustable Male Stud Elbow (45°) with Lock Nut
Type FI-VEE-...-M-OK • Series L / S**
**Adjustable Male Stud Branch Tee with Lock Nut
Type FI-TEE-...-M-OK • Series L / S**
**Adjustable Male Stud Barrel Tee with Lock Nut
Type FI-LEE-...-M-OK • Series L / S**
Type FI-VEE-...-M-OK

Metric Parallel Thread
O-Ring and Retaining Ring (Small)

Port acc. to ISO 9974-1

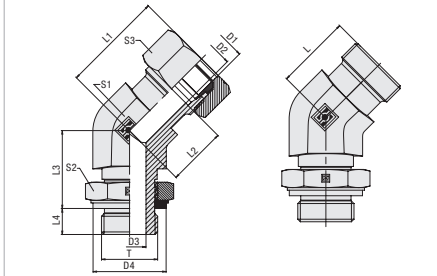

Dimensions L, L1, L2 and L3 deviating from the dimension table on the left.

Type FI-TEE-...-M-OK

Metric Parallel Thread
O-Ring and Retaining Ring (Small)

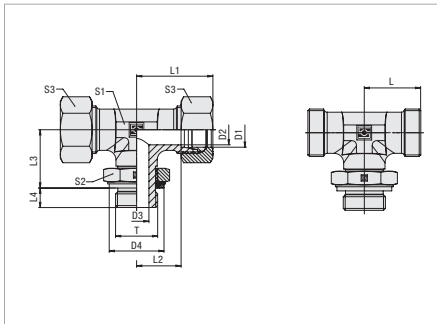

Port acc. to ISO 9974-1



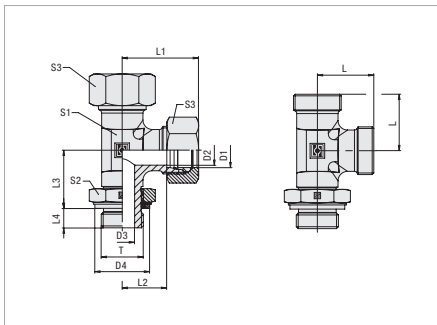

Type FI-LEE-...-M-OK

Metric Parallel Thread
O-Ring and Retaining Ring (Small)

Port acc. to ISO 9974-1

Connecting Parts

-  Cutting Ring
Type **FI-DS** Page 26
-  Soft-Sealing Cutting Ring
Type **FI-WDDS** Page 27
-  Support Sleeve
Type **FI-VH** Page 28

-  STAUFF Form Ring
Type **FI-AR** Page 30
-  Union Nut
Type **FI-M** Page 31
-  37° Flared Tube Fitting Set
Type **FI-AB** Page 35

Spare Parts / Accessories

-  O-Ring
Type **O-RING** Page 207
-  Retaining Ring (Small)
Type **FI-KR** Page 215



Adjustable Male Stud Elbow (90°) with Lock Nut
Type FI-WEE-...-M-OR • Series L / S

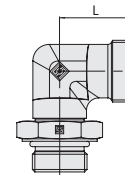
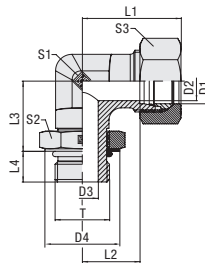

Metric Parallel Thread

O-Ring

Series	Tube OD (mm/in)	PN (bar/PSI)	Dimensions (mm/in)	Dimensions											Torque (Nm/ft-lb)	Weight (kg/lbs) ca.	Ordering Codes ³	
				Thread T	D2	D3	D4	L	L1 ¹	L2	L3	L4	S1	S2				S3
L	6	315	M 10 x 1	4	4	14,5	21	29	14	20	7	14	14	14	15	5,16	FI-WEE-06LM-OR-B-W3-MS	
	.24	4568		.16	.16	.57	.83	1.14	.55	.79	.28	.55	.55	.55	11.1	11.35		
	8	315		6	4	17,5	23	31	16	23,5	10	14	17	17	25	5,44		
	L	.31	4568	M 12 x 1,5	.24	.16	.69	.91	1.22	.63	.93	.39	.55	.67	.67	18.5	11.96	FI-WEE-08LM-OR-B-W3-MS
		10	315		8	5	19,5	24	32	17	27	10	19	19	19	35	9,00	
		.39	4568		.31	.20	.77	.94	1.26	.67	1.06	.39	.75	.75	.75	25.9	19.80	
	L	12	315	M 14 x 1,5	10	7	22,5	26	34	19	27	10	19	22	22	40	10,23	FI-WEE-10LM-OR-B-W3-MS
		.47	4568		.39	.28	.89	1.02	1.34	.75	1.06	.39	.75	.87	.87	29.6	22.51	
		15	315		12	8	24,5	28	36	21	29	11	22	24	27	45	14,59	
	L	.59	4568	M 18 x 1,5	.47	.31	.96	1.10	1.42	.83	1.14	.43	.87	.94	1.06	33.3	32.11	FI-WEE-15LM-OR-B-W3-MS
		18	250		15	12	27,5	31	40	23,5	36	12	27	27	32	60	23,09	
		.71	3625		.59	.47	1.08	1.22	1.57	.93	1.42	.47	1.06	1.06	1.26	44.4	50.80	
	L	22	160	M 22 x 1,5	19	16	32,5	35	44	27,5	38	14	30	32	36	100	39,11	FI-WEE-18LM-OR-B-W3-MS
		.87	2320		.75	.63	1.28	1.38	1.73	1.08	1.50	.55	1.18	1.26	1.42	74.0	86.04	
		28	160		24	20	41,5	38	47	30,5	47	14	36	41	41	160	61,54	
L	1.10	2320	M 27 x 2	.94	.79	1.63	1.50	1.85	1.20	1.85	.55	1.42	1.61	1.61	118.4	135.38	FI-WEE-22LM-OR-B-W3-MS	
	35	160		30	25	50,5	48	59	37,5	58	14	50	50	50	210	131,90		
	1.38	2320		1.18	.98	1.99	1.89	2.32	1.48	2.28	.55	1.97	1.97	1.97	155.4	290.18		
L	42	160	M 33 x 2	36	32	55,5	49	61	38	58,5	16	50	55	60	260	136,43	FI-WEE-28LM-OR-B-W3-MS	
	1.65	2320		1.42	1.26	2.19	1.93	2.40	1.50	2.30	.63	1.97	2.17	2.36	192.4	300.15		
	S	6		315	M 42 x 2	4	4	17,5	22	30	15	23,5	10	14	17	17		35
.24		4568	.16	.16		.69	.87	1.18	.59	.93	.39	.55	.67	.67	25.9	16.77		
8		315	5	5		19,5	24	32	17	27	10	19	19	19	45	11,98		
S		.31	4568	M 48 x 2	.20	.20	.77	.94	1.26	.67	1.06	.39	.75	.75	.75	33.3	26.35	FI-WEE-08SM-OR-B-W3-MS
		10	315		7	7	22,5	25	34	17,5	26	11	19	22	22	55	10,81	
		.39	4568		.28	.28	.89	.98	1.34	.69	1.02	.43	.75	.87	.87	40.7	23.79	
S		12	315	M 12 x 1,5	8	8	24,5	29	38	21,5	28	12	22	24	24	70	15,60	FI-WEE-10SM-OR-B-W3-MS
		.47	4568		.31	.31	.96	1.14	1.50	.85	1.10	.47	.87	.94	.94	51.8	34.32	
		16	250		12	12	27,5	33	43	24,5	34	14	27	27	30	100	24,52	
S		.63	3625	M 18 x 1,5	.47	.47	1.08	1.30	1.69	.96	1.34	.55	1.06	1.06	1.18	74.0	53.94	FI-WEE-12SM-OR-B-W3-MS
		20	250		16	16	32,5	38	49	27,5	36	16	30	32	36	170	33,16	
		.79	3625		.63	.63	1.28	1.50	1.93	1.08	1.42	.63	1.18	1.26	1.42	125.8	72.96	
S		25	160	M 22 x 1,5	20	20	41,5	42	54	30	45	16	36	41	46	310	56,70	FI-WEE-16SM-OR-B-W3-MS
		.98	2320		.79	.79	1.63	1.65	2.13	1.18	1.77	.63	1.42	1.61	1.81	229.4	124.74	
		30	160		25	25	50,5	49	62	35,5	55	17	50	50	330	144,57		
S	1.18	2320	M 27 x 2	.98	.98	1.99	1.93	2.44	1.40	2.17	.67	1.97	1.97	1.97	244.2	318.05	FI-WEE-20SM-OR-B-W3-MS	
	38	160		32	32	55,5	50	65	34	55,5	19	50	55	60	420	152,80		
	1.50	2320		1.26	1.26	2.19	1.97	2.56	1.34	2.19	.75	1.97	2.17	2.36	310.8	336.17		

¹ Approximate dimension in assembled condition.

² Weight excluding cutting ring and union nut.

³ Standard scope of delivery: Fitting body only.

Standard seal material is NBR (Buna-N®).

Male stud according to ISO 6149-2/-3

Port according to ISO 6149-1

Torque recommendations for Steel mating material.

Ordering Codes

***FI-WEE*-10*L*M*-OR*-B*-W3*-MS**

- * Adjustable Male Stud Elbow (90°) with Lock Nut **FI-WEE**
- * Outside Tube Diameter (in mm) **-10**
- * Series **L**
Light Series
S
Heavy Series
- * Thread Type **M**
Metric Parallel Thread

If required, please indicate special sizes, e.g. M26x1.5!

- * Seal Type **O-Ring** **-OR**
- * Seal Material **NBR (Buna-N®)** **-B**
FKM (Viton®) **-V**
EPDM **-E**
- * Material Code **Steel, zinc/nickel-plated** **-W3**

Please contact STAUFF for alternative materials and surface finishings.

- * Assembling / Kitting **Fitting body only** **—**
- Fitting body supplied with cutting ring and union nut** **-MS**
- Fitting body supplied with soft-sealing cutting ring and union nut** **-MSV**



**Adjustable Male Stud Elbow (45°) with Lock Nut
Type FI-VEE-...-M-OR • Series L / S**
**Adjustable Male Stud Branch Tee with Lock Nut
Type FI-TEE-...-M-OR • Series L / S**
**Adjustable Male Stud Barrel Tee with Lock Nut
Type FI-LEE-...-M-OR • Series L / S**
Type FI-VEE-...-M-OR

Metric Parallel Thread
O-Ring

Male stud according to ISO 6149-2/-3
Port according to ISO 6149-1

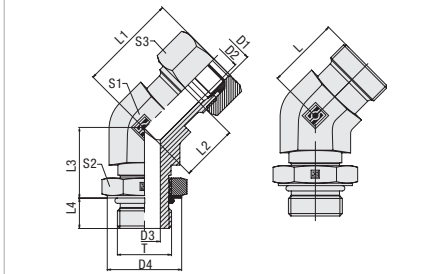

Dimensions L, L1, L2 and L3 deviating from the dimension table on the left.

Type FI-TEE-...-M-OR

Metric Parallel Thread
O-Ring

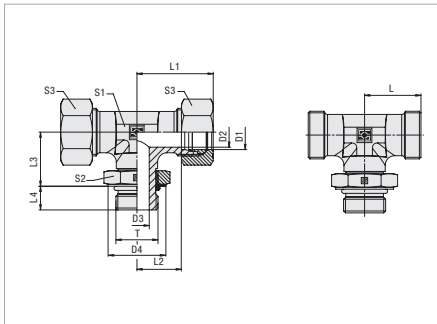

Male stud according to ISO 6149-2/-3
Port according to ISO 6149-1



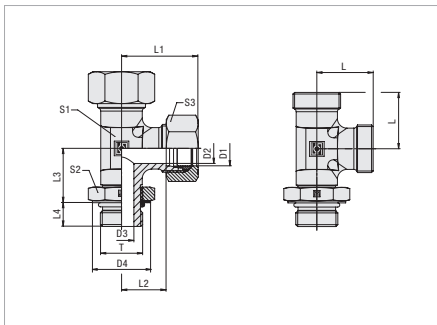

Type FI-LEE-...-M-OR

Metric Parallel Thread
O-Ring

Male stud according to ISO 6149-2/-3
Port according to ISO 6149-1

Connecting Parts

-  Cutting Ring
Type **FI-DS** Page 26
-  Soft-Sealing Cutting Ring
Type **FI-WDDS** Page 27
-  Support Sleeve
Type **FI-VH** Page 28

-  STAUFF Form Ring
Type **FI-AR** Page 30
-  Union Nut
Type **FI-M** Page 31
-  37° Flared Tube Fitting Set
Type **FI-AB** Page 35

Spare Parts / Accessories

-  O-Ring
Type **O-RING** Page 207



Adjustable Male Stud Elbow (90°) with Lock Nut
Type FI-WEE-...-U • Series L / S

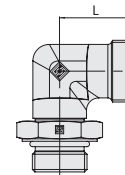
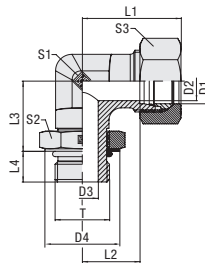

UN/UNF Thread

O-Ring

Series	Tube OD (mm/in)	PN (bar/PSI)	Dimensions (mm/in)													Torque (Nm/ft-lb)	Weight (kg/lbs) ca. per 100 ²	Ordering Codes ³
			Thread T	D2	D3	D4	L	L1 ¹	L2	L3	L4	S1	S2	S3	Thread T			
L	6	315	7/16-20 UNF	4	4,5	16,5	21	29	14	21	11	14	17	14	20	5,02	FI-WEE-06L7/16U-OR-B-W3	
	.24	4568		.16	.18	.65	.83	1.14	.55	.83	.43	.55	.67	.55	14.8	11.04		
	8	315		6	4,5	16,5	23	31	16	21	11	14	17	17	20	5,16		
		.31	4568	7/16-20 UNF	.24	.18	.65	.91	1.22	.63	.83	.43	.55	.67	.67	14.8	11.36	FI-WEE-08L7/16U-OR-B-W3
		10	315		8	7,5	20,2	24	32	17	25	12	19	19	19	18	14,99	
		.39	4568		.31	.30	.80	.94	1.26	.67	.98	.47	.75	.75	.75	13.3	32.97	
		12	315	9/16-18 UNF	10	7,5	20,2	26	34	19	25,5	12	19	19	22	18	15,29	FI-WEE-12L9/16U-OR-B-W3
		.47	4568		.39	.30	.80	1.02	1.34	.75	1.00	.47	.75	.75	.87	13.3	33.63	
		15	315		12	10	25,7	28	36	21	30	14	22	24	27	16	15,03	
		.59	4568	3/4-16 UNF	.47	.39	1.01	1.10	1.42	.83	1.18	.55	.87	.94	1.06	11.8	33.07	FI-WEE-15L3/4U-OR-B-W3
		18	250		15	12,5	29,3	31	40	23,5	35	16	27	27	32	14	24,03	
		.71	3625		.59	.49	1.15	1.22	1.57	.93	1.38	.63	1.06	1.06	1.26	10.4	52.87	
		22	160	1 1/16-12 UN	19	15,5	36,7	35	44	27,5	39	18	30	36	36	12	35,96	FI-WEE-22L1-1/16U-OR-B-W3
		.87	2320		.75	.61	1.44	1.38	1.73	1.08	1.54	.71	1.18	1.42	1.42	8.9	79.11	
		28	160		24	21,5	44	38	47	30,5	43	18	36	41	41	12	49,38	
	1.10	2320	1 5/16-12 UN	.94	.85	1.73	1.50	1.85	1.20	1.69	.71	1.42	1.61	1.61	8.9	108.64	FI-WEE-28L1-5/16U-OR-B-W3	
	35	160		30	27,5	55	48	59	37,5	50	18	50	50	50	12	106,22		
	1.38	2320		1.18	1.08	2.17	1.89	2.32	1.48	1.97	.71	1.97	1.97	1.97	8.9	233.69		
	42	160	1 7/8-12 UN	36	33,5	62,3	49	61	37,89	52	18	50	55	60	12	101,73	FI-WEE-42L1-7/8U-OR-B-W3	
	1.65	2320		1.42	1.32	2.45	1.93	2.40	1.49	2.05	.71	1.97	2.17	2.36	8.9	223.81		
	S	6		315	7/16-20 UNF	4	4,5	16,5	22	30	15	21	11	14	17	17		20
.24		4568	.16	.18		.65	.87	1.18	.59	.83	.43	.55	.67	.67	14.8	13.03		
8		315	5	7,5		20,2	24	32	17	25	12	19	19	19	18	9,45		
		.31	4568	9/16-18 UNF	.20	.30	.80	.94	1.26	.67	.98	.47	.75	.75	.75	13.3	20.79	FI-WEE-08S9/16U-OR-B-W3
		10	315		7	7,5	20,2	25	34	17,5	25,5	12	19	19	22	18	9,80	
		.39	4568		.28	.30	.80	.98	1.34	.69	1.00	.47	.75	.75	.87	13.3	21.56	
		12	315	3/4-16 UNF	8	10	25,7	29	38	21,5	30	14	22	24	24	16	16,06	FI-WEE-12S3/4U-OR-B-W3
		.47	4568		.31	.39	1.01	1.14	1.50	.85	1.18	.55	.87	.94	.94	11.8	35.34	
		16	250		12	12,5	29,3	33	43	24,5	35	16	27	27	30	14	25,18	
		.63	3625	7/8-14 UNF	.47	.49	1.15	1.30	1.69	.96	1.38	.63	1.06	1.06	1.18	10.4	55.40	FI-WEE-16S7/8U-OR-B-W3
		20	250		16	15,5	36,7	38	49	27,5	39	18	30	36	36	12	38,53	
		.79	3625		.63	.61	1.44	1.50	1.93	1.08	1.54	.71	1.18	1.42	1.42	8.9	84.76	
		25	160	1 1/16-12 UN	20	15,5	36,7	42	54	30	43	18	36	36	46	12	53,90	FI-WEE-20S1-1/16U-OR-B-W3
		.98	2320		.79	.61	1.44	1.65	2.13	1.18	1.69	.71	1.42	1.42	1.81	8.9	118.58	
		30	160		25	27,5	55	49	62	35,5	50	18	50	50	50	12	110,22	
	1.18	2320	1 5/8-12 UN	.98	1.08	2.17	1.93	2.44	1.40	1.97	.71	1.97	1.97	1.97	8.9	242.49	FI-WEE-30S1-5/8U-OR-B-W3	
	38	160		32	33,5	62,3	50	65	33,9	52	18	50	55	60	12	109,43		
	1.50	2320		1.26	1.32	2.45	1.97	2.56	1.33	2.05	.71	1.97	2.17	2.36	8.9	240.75		

¹ Approximate dimension in assembled condition.

² Weight excluding cutting ring and union nut.

³ Standard scope of delivery: Fitting body only.

Standard seal material is NBR (Buna-N®).

Male stud acc. to ISO 11926-2/-3

Port acc. to ISO 11926-1

Torque recommendations for Steel mating material.

Ordering Codes

***FI-WEE*-10*L*9/16*U*-OR*-B*-W3*-MS**

- * Adjustable Male Stud Elbow (90°) with Lock Nut **FI-WEE**
- * Outside Tube Diameter (in mm) **-10**
- * Series Light Series **L**
Heavy Series **S**
- * Thread Size acc. to dimension table **9/16**

Please always indicate thread sizes, e.g. 9/16!

- * Thread Type UN/UNF Thread with O-Ring **U**
- * Seal Material NBR (Buna-N®) **-B**
FKM (Viton®) **-V**
EPDM **-E**
- * Material Code Steel, zinc/nickel-plated **-W3**

Please contact STAUFF for alternative materials and surface finishings.

- * Assembling / Kitting Fitting body only **—**
- Fitting body supplied with cutting ring and union nut **-MS**
- Fitting body supplied with soft-sealing cutting ring and union nut **-MSV**



**Adjustable Male Stud Elbow (45°) with Lock Nut
Type FI-VEE-...-U • Series L / S**
**Adjustable Male Stud Branch Tee with Lock Nut
Type FI-TEE-...-U • Series L / S**
**Adjustable Male Stud Barrel Tee with Lock Nut
Type FI-LEE-...-U • Series L / S**
Type FI-VEE-...-U

UN/UNF Thread
O-Ring

Male stud according to ISO 6149-2/-3
Port according to ISO 6149-1

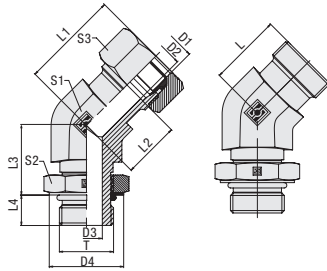

Dimensions L, L1, L2 and L3 deviating from the dimension table on the left.

Type FI-TEE-...-U

UN/UNF Thread
O-Ring

Male stud according to ISO 6149-2/-3
Port according to ISO 6149-1

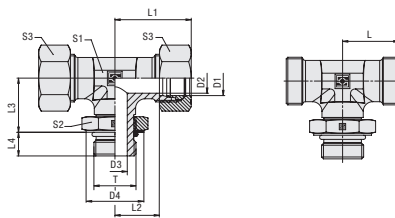
Type FI-LEE-...-U

UN/UNF Thread
O-Ring

Male stud according to ISO 6149-2/-3
Port according to ISO 6149-1

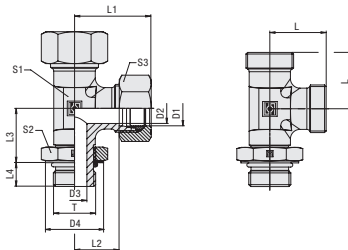
Connecting Parts

Cutting Ring
Type **FI-DS** Page 26



Soft-Sealing Cutting Ring
Type **FI-WDDS** Page 27



Support Sleeve
Type **FI-VH** Page 28



STAUFF Form Ring
Type **FI-AR** Page 30



Union Nut
Type **FI-M** Page 31



37° Flared Tube Fitting Set
Type **FI-AB** Page 35

Spare Parts / Accessories

O-Ring
Type **O-RING** Page 207





Banjo Elbow (Medium-Pressure Version)
 FI-RSWND 158-161

**Whitworth Parallel Pipe Thread (BSPP) /
 External Metallic Sealing Ring**
 FI-RSWND-...-R-DK 158

**Metric Parallel Thread /
 External Metallic Sealing Ring**
 FI-RSWND-...-M-DK 159

**Whitworth Parallel Pipe Thread (BSPP) /
 Retaining Ring with Captive Seal**
 FI-RSWND-...-R-WD 160

**Metric Parallel Thread /
 Retaining Ring with Captive Seal**
 FI-RSWND-...-M-WD 161

Banjo Elbow (High-Pressure Version)
 FI-RSW 162-165

**Whitworth Parallel Pipe Thread (BSPP) /
 External Metallic Sealing Ring**
 FI-RSW-...-R-DK 162

**Metric Parallel Thread /
 External Metallic Sealing Ring**
 FI-RSW-...-M-DK 163

**Whitworth Parallel Pipe Thread (BSPP) /
 Retaining Ring with Captive Seal**
 FI-RSW-...-R-WD 164

**Metric Parallel Thread /
 Retaining Ring with Captive Seal**
 FI-RSW-...-M-WD 165

Banjo Tee (High-Pressure Version)
 FI-RST 166-169

**Whitworth Parallel Pipe Thread (BSPP) /
 External Metallic Sealing Ring**
 FI-RST-...-R-DK 166

**Metric Parallel Thread /
 External Metallic Sealing Ring**
 FI-RST-...-M-DK 167

**Whitworth Parallel Pipe Thread (BSPP) /
 Retaining Ring with Captive Seal**
 FI-RST-...-R-WD 168

**Metric Parallel Thread /
 Retaining Ring with Captive Seal**
 FI-RST-...-M-WD 169

K

Banjo Elbow (Medium-Pressure Version)
Type FI-RSWND-...-R-DK • Series LL / L / S

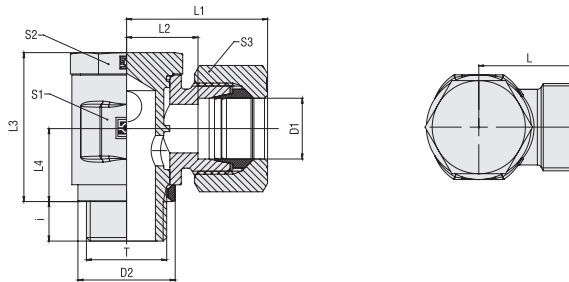

Whitworth Parallel Pipe Thread (BSPP)

External Metallic Sealing Ring

Ordering Codes

***FI-RSWND*-10*L*R*-DK*-W3*-MS**

* Banjo Elbow (Medium-Pressure Version) **FI-RSWND**

* Outside Tube Diameter D1 (in mm) **-10**

* Series Extra-Light Series **LL**
 Light Series **L**
 Heavy Series **S**

* Thread Type Whitworth Parallel Pipe Thread (BSPP) **R**

If required, please indicate special sizes, e.g. R1/8!

* Seal Type External Metallic Sealing Ring **-DK**

* Material Code Steel, zinc/nickel-plated **-W3**

Please contact STAUFF for alternative materials and surface finishings.

* Assembling / Kitting Fitting body only **—**

Fitting body supplied with cutting ring and union nut **-MS**

Fitting body supplied with soft-sealing cutting ring and union nut **-MSV**

Series	Tube OD (mm/in)	PB (bar/psi)	Dimensions (mm/in)										Weight (kg/lbs) ca. per 100 ²	Ordering Codes ³		
			D1	Thread	T	D2	L	L1 ¹	L2	L3	L4	i			S1	S2
LL	4	100	G 1/8	13	15,5	21	11,5	21	10	6	14	14	10	2,85	FI-RSWND-04LLR-DK-W3	
	.16	1450		.51	.61	.83	.45	.83	.39	.24	.55	.55	.39	6.27		
	6	100	G 1/8	13	15,5	21	10	21	10	6	14	14	12	2,85	FI-RSWND-06LLR-DK-W3	
	.24	1450		.51	.61	.83	.39	.83	.39	.24	.55	.55	.47	6.27		
	8	100	G 1/8	13	16,5	23	11	21	10	6	14	14	14	2,93	FI-RSWND-08LLR-DK-W3	
	.31	1450		.51	.65	.91	.43	.83	.39	.24	.55	.55	.55	6.45		
L	6	250	G 1/8	13	18,5	25	11,5	21	10	6	14	14	14	3,15	FI-RSWND-06LR-DK-W3	
	.24	3625		.51	.73	.98	.45	.83	.39	.24	.55	.55	.55	6.93		
	8	250	G 1/4	17,7	20	26	13	26	12	10	17	19	17	5,85	FI-RSWND-08LR-DK-W3	
	.31	3625		.70	.79	1.02	.51	1.02	.47	.39	.67	.75	.67	12.88		
	10	250	G 1/4	17,7	22	30	15	27	13	9	19	19	19	6,95	FI-RSWND-10LR-DK-W3	
	.39	3625		.70	.87	1.18	.59	1.06	.51	.35	.75	.75	.75	15.29		
	12	160	G 3/8	22	23	31	16	32	15	9	22	22	22	6,77	FI-RSWND-12LR-DK-W3	
	.47	2320		.87	.91	1.22	.63	1.26	.59	.35	.87	.87	.87	14.90		
	15	160	G 1/2	26	26,5	35	19,5	37,5	18	11	27	27	27	17,36	FI-RSWND-15LR-DK-W3	
	.59	2320		1.02	1.04	1.38	.77	1.48	.71	.43	1.06	1.06	1.06	38.18		
	18	160	G 1/2	26	27	36	19,5	44,5	21,5	11	30	27	32	21,47	FI-RSWND-18LR-DK-W3	
	.71	2320		1.02	1.06	1.42	.77	1.75	.85	.43	1.18	1.06	1.26	47.23		
	22	160	G 3/4	32	32	41	24,5	49	24	13	36	32	36	30,63	FI-RSWND-22LR-DK-W3	
	.87	2320		1.26	1.26	1.61	.96	1.93	.94	.51	1.42	1.26	1.42	67.38		
	S	6	250	G 1/4	17,7	21,5	29	14,5	26	12	10	17	19	17	6,23	FI-RSWND-06SR-DK-W3
		.24	3625		.70	.85	1.14	.57	1.02	.47	.39	.67	.75	.67	13.70	
		8	250	G 1/4	17,7	23	29	16	27	13	9	19	19	19	7,47	FI-RSWND-08SR-DK-W3
		.31	3625		.70	.91	1.14	.63	1.06	.51	.35	.75	.75	.75	16.43	
10		160	G 3/8	22	23,5	32	16	32	15	9	22	22	22	10,92	FI-RSWND-10SR-DK-W3	
.39		2320		.87	.93	1.26	.63	1.26	.59	.35	.87	.87	.87	24.03		
12		160	G 3/8	22	26	34	18,5	37	18	9	24	24	24	14,87	FI-RSWND-12SR-DK-W3	
.47		2320		.87	1.02	1.34	.73	1.46	.71	.35	.94	.94	.94	32.71		
14		160	G 1/2	26	28,5	39	20,5	37,5	18	11	27	27	27	18,58	FI-RSWND-14SR-DK-W3	
.55		2320		1.02	1.12	1.54	.81	1.48	.71	.43	1.06	1.06	1.06	40.88		
16		160	G 1/2	26	30	40	21,5	44,5	21,5	11	30	27	30	22,48	FI-RSWND-16SR-DK-W3	
.63		2320		1.02	1.18	1.57	.85	1.75	.85	.43	1.18	1.06	1.18	49.45		
20	160	G 3/4	32	34	45	23,5	49	24	13	36	32	36	32,20	FI-RSWND-20SR-DK-W3		
.79	2320		1.26	1.34	1.77	.93	1.93	.94	.51	1.42	1.26	1.42	70.84			

¹ Approximate dimension in assembled condition.

² Weight excluding cutting ring and union nut.

³ Standard scope of delivery: Fitting body only.

Port acc. to DIN 3852-2 (Form X) / ISO 1179-1

K

Connecting Parts

-  Cutting Ring Type **FI-DS** Page 26
-  Soft-Sealing Cutting Ring Type **FI-WDDS** Page 27
-  Support Sleeve Type **FI-VH** Page 28
-  STAUFF Form Ring Type **FI-AR** Page 30
-  Union Nut Type **FI-M** Page 31
-  37° Flared Tube Fitting Set Type **FI-AB** Page 35

Spare Parts / Accessories

-  External Metallic Sealing Ring Type **FI-DKR** Page 212

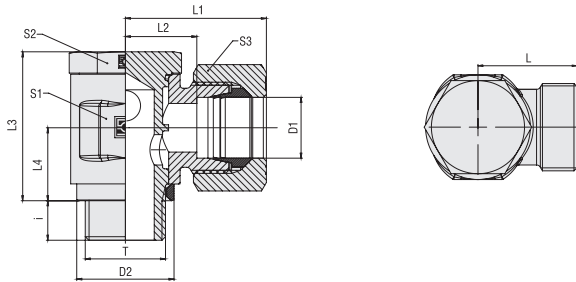

**Banjo Elbow (Medium-Pressure Version)
Type FI-RSWND-...-M-DK ■ Series LL / L / S**

External Metallic Sealing Ring
Metric Parallel Thread

Series	Tube OD		Dimensions (mm/in)	Dimensions											Weight (kg/lbs) ca. per 100 ²	Ordering Codes ³
	(mm/in)	PB (bar/psi)		Thread	T	D2	L	L1 ¹	L2	L3	L4	i	S1	S2		
LL	4	100	M 8 x 1	10,8	15,5	21	11,5	17	8	6	14	12	10	2,66	FI-RSWND-04LLM-DK-W3	
	.16	1450		.43	.61	.83	.45	.67	.31	.24	.55	.47	.39	5,85		
	6	100	M 10 x 1	13	15,5	21	10	21	10	6	14	14	12	2,86	FI-RSWND-06LLM-DK-W3	
	.24	1450		.51	.61	.83	.39	.83	.39	.24	.55	.55	.47	6,30		
	8	100	M 10 x 1	13	16,5	23	11	21	10	6	14	14	14	2,94	FI-RSWND-08LLM-DK-W3	
.31	1450	.51		.65	.91	.43	.83	.39	.24	.55	.55	.55	6,47			
L	6	250	M 10 x 1	13	18,5	26	11,5	21	10	6	14	14	14	3,16	FI-RSWND-06LM-DK-W3	
	.24	3625		.51	.73	1.02	.45	.83	.39	.24	.55	.55	.55	6,95		
	8	250	M 12 x 1,5	17,8	20	28	13	25	12	9	17	17	17	5,02	FI-RSWND-08LM-DK-W3	
	.31	3625		.70	.79	1.10	.51	.98	.47	.35	.67	.67	.67	11,04		
	10	250	M 14 x 1,5	17,8	22	30	15	27	13	9	19	19	19	7,02	FI-RSWND-10LM-DK-W3	
	.39	3625		.70	.87	1.18	.59	1.06	.51	.35	.75	.75	.75	15,44		
	12	160	M 16 x 1,5	21,5	23	31	16	32	15	9	22	22	22	6,63	FI-RSWND-12LM-DK-W3	
	.47	2320		.85	.91	1.22	.63	1.26	.59	.35	.87	.87	.87	14,58		
	15	160	M 18 x 1,5	23	25	33	18	37	18	9	24	24	27	13,44	FI-RSWND-15LM-DK-W3	
	.59	2320		.91	.98	1.30	.71	1.46	.71	.35	.94	.94	1.06	29,56		
	18	160	M 22 x 1,5	27	27	36	19,5	44,5	21,5	11	30	27	32	22,82	FI-RSWND-18LM-DK-W3	
	.71	2320		1.06	1.06	1.42	.77	1.75	.85	.43	1.18	1.06	1.26	50,20		
	22	160	M 26 x 1,5	31	32	41	24,5	49	24	13	36	32	36	30,46	FI-RSWND-22LM-DK-W3	
	.87	2320		1.22	1.26	1.61	.96	1.93	.94	.51	1.42	1.26	1.42	67,01		
	S	6	250	M 12 x 1,5	17,8	21,5	29	14,5	25	12	9	17	17	17	5,39	FI-RSWND-06SM-DK-W3
		.24	3625		.70	.85	1.14	.57	.98	.47	.35	.67	.67	.67	11,86	
		8	250	M 14 x 1,5	17,8	23	31	16	27	13	9	19	19	19	7,54	FI-RSWND-08SM-DK-W3
		.31	3625		.70	.91	1.22	.63	1.06	.51	.35	.75	.75	.75	16,58	
		10	160	M 16 x 1,5	21,5	23,5	32,5	16	32	15	9	22	22	22	10,78	FI-RSWND-10SM-DK-W3
.39		2320	.85		.93	1.28	.63	1.26	.59	.35	.87	.87	.87	23,71		
12		160	M 18 x 1,5	23	25	34	17,5	37	18	9	24	24	24	13,70	FI-RSWND-12SM-DK-W3	
.47		2320		.91	.98	1.34	.69	1.46	.71	.35	.94	.94	.94	30,14		
14		160	M 20 x 1,5	26	28,5	38,5	20,5	37	18	11	27	27	27	17,94	FI-RSWND-14SM-DK-W3	
.55		2320		1.02	1.12	1.52	.81	1.46	.71	.43	1.06	1.06	1.06	39,47		
16		160	M 22 x 1,5	27	30	40	21,5	44,5	21,5	11	30	27	30	23,83	FI-RSWND-16SM-DK-W3	
.63	2320	1.06		1.18	1.57	.85	1.75	.85	.43	1.18	1.06	1.18	52,42			
20	160	M 27 x 2	32	34	45	23,5	49	24	13	36	32	36	33,34	FI-RSWND-20SM-DK-W3		
.79	2320		1.26	1.34	1.77	.93	1.93	.94	.51	1.42	1.26	1.42	73,35			

¹ Approximate dimension in assembled condition.

Port acc. to DIN 3852-1 (Form X) / ISO 9974-1

² Weight excluding cutting ring and union nut.

³ Standard scope of delivery: Fitting body only.

Ordering Codes
***FI-RSWND*-10*L*R*-DK*-W3*-MS**

 * Banjo Elbow (Medium-Pressure Version) **FI-RSWND**

 * Outside Tube Diameter D1 (in mm) **-10**

 * Series Extra-Light Series **LL**
 Light Series **L**
 Heavy Series **S**

 * Thread Type Metric Parallel Thread **M**

If required, please indicate special sizes, e.g. M12x1.5!

 * Seal Type External Metallic Sealing Ring **-DK**

 * Material Code Steel, zinc/nickel-plated **-W3**

Please contact STAUFF for alternative materials and surface finishings.

 * Assembling / Kitting Fitting body only **—**

 Fitting body supplied with cutting ring and union nut **-MS**

 Fitting body supplied with soft-sealing cutting ring and union nut **-MSV**
Connecting Parts

	Cutting Ring Type FI-DS	Page 26
	Soft-Sealing Cutting Ring Type FI-WDDS	Page 27
	Support Sleeve Type FI-VH	Page 28
	STAUFF Form Ring Type FI-AR	Page 30
	Union Nut Type FI-M	Page 31
	37° Flared Tube Fitting Set Type FI-AB	Page 35

Spare Parts / Accessories

	External Metallic Sealing Ring Type FI-DKR	Page 212
--	--	----------



Banjo Elbow (Medium-Pressure Version)
Type FI-RSND-...-R-WD ▪ Series L / S

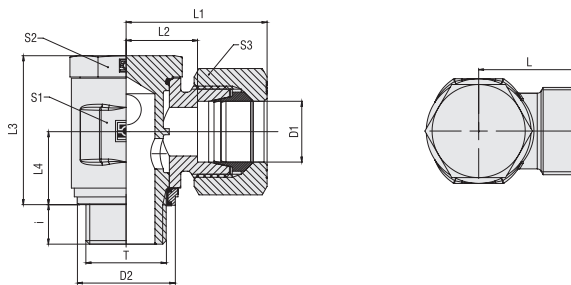

Whitworth Parallel Pipe Thread (BSPP)

Retaining Ring with Captive Seal

Ordering Codes

***FI-RSND*-10*L*R*-WD*-B*-W3*-MS**

* Banjo Elbow (Medium-Pressure Version) **FI-RSND**

* Outside Tube Diameter D1 (in mm) **-10**

* Series **LL** Extra-Light Series
L Light Series
S Heavy Series

* Thread Type **R** Whitworth Parallel Pipe Thread (BSPP)

If required, please indicate special sizes, e.g. R1/8!

* Seal Type **-WD** Retaining Ring with Captive Seal

* Seal Material **-B** NBR (Buna-N®)
-V FKM (Viton®)
-E EPDM

* Material Code **-W3** Steel, zinc/nickel-plated

Please contact STAUFF for alternative materials and surface finishings.

* Assembling / Kitting **—** Fitting body only
-MS Fitting body supplied with cutting ring and union nut
-MSV Fitting body supplied with soft-sealing cutting ring and union nut

Series	Tube OD (mm/in)	PB (mm/PSI)	Dimensions (mm/in)										Weight (kg/lbs) ca. per 100 ²	Ordering Codes ³	
			D1	Thread	T	D2	L	L1 ¹	L2	L3	L4	i			S1
L	6	250	G 1/8	15	18,5	25	11,5	21	10	6	14	14	14	3,07	FI-RSND-06LR-WD-B-W3
	.24	3625		.59	.73	.98	.45	.83	.39	.24	.55	.55	.55	6,75	
	8	250	G 1/4	18,8	20	26	13	26	12	10	17	19	17	5,97	FI-RSND-08LR-WD-B-W3
	.31	3625		.74	.79	1.02	.51	1.02	.47	.39	.67	.75	.67	13,14	
	10	250	G 1/4	18,8	22	30	15	27	13	9	19	19	19	7,60	FI-RSND-10LR-WD-B-W3
	.39	3625		.74	.87	1.18	.59	1.06	.51	.35	.75	.75	.75	16,71	
	12	160	G 3/8	22	23	31	16	32	15	9	22	22	22	10,45	FI-RSND-12LR-WD-B-W3
	.47	2320		.87	.91	1.22	.63	1.26	.59	.35	.87	.87	.87	22,99	
	15	160	G 1/2	28,8	26,5	35	19,5	37,5	18	11	27	27	27	18,00	FI-RSND-15LR-WD-B-W3
	.59	2320		1.13	1.04	1.38	.77	1.48	.71	.43	1.06	1.06	1.06	39,59	
	18	160	G 1/2	28,8	27	36	19,5	44,5	21,5	11	30	27	32	22,31	FI-RSND-18LR-WD-B-W3
	.71	2320		1.13	1.06	1.42	.77	1.75	.85	.43	1.18	1.06	1.26	49,08	
22	160	G 3/4	33	32	41	24,5	49	24	13	36	32	36	31,05	FI-RSND-22LR-WD-B-W3	
.87	2320		1.30	1.26	1.61	.96	1.93	.94	.51	1.42	1.26	1.42	68,30		
S	6	250	G 1/4	18,8	21,5	29	14,5	26	12	10	17	19	17	6,34	FI-RSND-06SR-WD-B-W3
	.24	3625		.74	.85	1.14	.57	1.02	.47	.39	.67	.75	.67	13,96	
	8	250	G 1/4	18,8	23	29	16	27	13	9	19	19	19	7,60	FI-RSND-08SR-WD-B-W3
	.31	3625		.74	.91	1.14	.63	1.06	.51	.35	.75	.75	.75	16,71	
	10	160	G 3/8	22	23,5	32	16	32	15	9	22	22	22	10,89	FI-RSND-10SR-WD-B-W3
	.39	2320		.87	.93	1.26	.63	1.26	.59	.35	.87	.87	.87	23,96	
	12	160	G 3/8	22	26	34	18,5	37	18	9	24	24	24	14,51	FI-RSND-12SR-WD-B-W3
	.47	2320		.87	1.02	1.34	.73	1.46	.71	.35	.94	.94	.94	31,92	
	14	160	G 1/2	28,8	28,5	39	20,5	37,5	18	11	27	27	27	18,77	FI-RSND-14SR-WD-B-W3
	.55	2320		1.13	1.12	1.54	.81	1.48	.71	.43	1.06	1.06	1.06	41,30	
	16	160	G 1/2	28,8	30	40	21,5	44,5	21,5	11	30	27	30	23,32	FI-RSND-16SR-WD-B-W3
	.63	2320		1.13	1.18	1.57	.85	1.75	.85	.43	1.18	1.06	1.18	51,29	
20	160	G 3/4	33	34	45	23,5	49	24	13	36	32	36	32,63	FI-RSND-20SR-WD-B-W3	
.79	2320		1.30	1.34	1.77	.93	1.93	.94	.51	1.42	1.26	1.42	71,79		

¹ Approximate dimension in assembled condition.

² Weight excluding cutting ring and union nut.

³ Standard scope of delivery: Fitting body only.

Port acc. to DIN 3852-2 (Form X) / ISO 1179-1

Standard seal material is NBR (Buna-N®).

Connecting Parts

- Cutting Ring Type **FI-DS** Page 26
- Soft-Sealing Cutting Ring Type **FI-WDDS** Page 27
- Support Sleeve Type **FI-VH** Page 28
- STAUFF Form Ring Type **FI-AR** Page 30
- Union Nut Type **FI-M** Page 31
- 37° Flared Tube Fitting Set Type **FI-AB** Page 35

Spare Parts / Accessories

- Retaining Ring with Captive Seal Type **FI-DIR** Page 213
- O-Ring Type **O-RING** Page 207

K

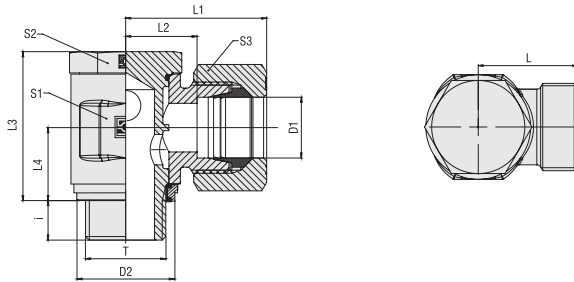

**Banjo Elbow (Medium-Pressure Version)
Type FI-RSWND-...-M-WD ■ Series L / S**

Retaining Ring with Captive Seal
Metric Parallel Thread

Series	Tube OD (mm/in)	PB (bar/psi)	Dimensions (mm/in)											Weight (kg/lbs) ca. per 100 ²	Ordering Codes ³
			Thread	T	D2	L	L ¹	L2	L3	L4	i	S1	S2		
L	6	250	M 10 x 1	15	18,5	26	11,5	21	10	6	14	14	14	3,10	FI-RSWND-06LM-WD-B-W3
	.24	3625		.59	.73	1.02	.45	.83	.39	.24	.55	.55	.55	6.83	
	8	250	M 12 x 1,5	17,8	20	28	13	25	12	9	17	17	17	5,20	FI-RSWND-08LM-WD-B-W3
	.31	3625		.70	.79	1.10	.51	.98	.47	.35	.67	.67	.67	11.44	
	10	250	M 14 x 1,5	20	22	30	15	27	13	9	19	19	19	7,31	FI-RSWND-10LM-WD-B-W3
	.39	3625		.79	.87	1.18	.59	1.06	.51	.35	.75	.75	.75	16.07	
	12	160	M 16 x 1,5	22	23	31	16	32	15	9	22	22	22	10,27	FI-RSWND-12LM-WD-B-W3
	.47	2320		.87	.91	1.22	.63	1.26	.59	.35	.87	.87	.87	22.59	
	15	160	M 18 x 1,5	25,8	25	33	18	37	18	9	24	24	27	13,86	FI-RSWND-15LM-WD-B-W3
	.59	2320		1.02	.98	1.30	.71	1.46	.71	.35	.94	.94	1.06	30.49	
	18	160	M 22 x 1,5	28,8	27	36	19,5	44,5	21,5	11	30	27	32	22,65	FI-RSWND-18LM-WD-B-W3
	.71	2320		1.13	1.06	1.42	.77	1.75	.85	.43	1.18	1.06	1.26	49.84	
22	160	M 26 x 1,5	32	32	41	24,5	49	24	13	36	32	36	30,84	FI-RSWND-22LM-WD-B-W3	
.87	2320		1.26	1.26	1.61	.96	1.93	.94	.51	1.42	1.26	1.42	67.85		
S	6	250	M 12 x 1,5	17,8	21,5	29	14,5	25	12	9	17	17	17	5,57	FI-RSWND-06SM-WD-B-W3
	.24	3625		.70	.85	1.14	.57	.98	.47	.35	.67	.67	.67	12.25	
	8	250	M 14 x 1,5	20	23	31	16	27	13	9	19	19	19	7,82	FI-RSWND-08SM-WD-B-W3
	.31	3625		.79	.91	1.22	.63	1.06	.51	.35	.75	.75	.75	17.21	
	10	160	M 16 x 1,5	22	23,5	32,5	16	32	15	9	22	22	22	10,71	FI-RSWND-10SM-WD-B-W3
	.39	2320		.87	.93	1.28	.63	1.26	.59	.35	.87	.87	.87	23.56	
	12	160	M 18 x 1,5	25,8	25	34	17,5	37	18	9	24	24	24	14,12	FI-RSWND-12SM-WD-B-W3
	.47	2320		1.02	.98	1.34	.69	1.46	.71	.35	.94	.94	.94	31.07	
	16	160	M 22 x 1,5	28,8	30	40	21,5	44,5	21,5	11	30	27	30	23,66	FI-RSWND-16SM-WD-B-W3
	.63	2320		1.13	1.18	1.57	.85	1.75	.85	.43	1.18	1.06	1.18	52.05	
	20	160	M 27 x 2	33	34	45	23,5	49	24	13	36	32	36	33,01	FI-RSWND-20SM-WD-B-W3
	.79	2320		1.30	1.34	1.77	.93	1.93	.94	.51	1.42	1.26	1.42	72.62	

¹ Approximate dimension in assembled condition.

Port acc. to DIN 3852-1 (Form X) / ISO 9974-1

² Weight excluding cutting ring and union nut.

³ Standard scope of delivery: Fitting body only.

Standard seal material is NBR (Buna-N®).

Ordering Codes
***FI-RSWND*-10*L*R*-WD*-B*-W3*-MS**
*** Banjo Elbow (Medium-Pressure Version) FI-RSWND**
*** Outside Tube Diameter D1 (in mm) -10**
*** Series**
 Extra-Light Series **LL**
 Light Series **L**
 Heavy Series **S**
*** Thread Type** Metric Parallel Thread **M**

If required, please indicate special sizes, e.g. M12x1.5!

*** Seal Type** Retaining Ring with Captive Seal **-WD**
*** Seal Material**
 NBR (Buna-N®) **-B**
 FKM (Viton®) **-V**
 EPDM **-E**
*** Material Code** Steel, zinc/nickel-plated **-W3**

Please contact STAUFF for alternative materials and surface finishings.

*** Assembling / Kitting** Fitting body only **—**
 Fitting body supplied with cutting ring and union nut **-MS**
 Fitting body supplied with soft-sealing cutting ring and union nut **-MSV**
Connecting Parts

	Cutting Ring Type FI-DS	Page 26
	Soft-Sealing Cutting Ring Type FI-WDDS	Page 27
	Support Sleeve Type FI-VH	Page 28
	STAUFF Form Ring Type FI-AR	Page 30
	Union Nut Type FI-M	Page 31
	37° Flared Tube Fitting Set Type FI-AB	Page 35

Spare Parts / Accessories

	Retaining Ring with Captive Seal Type FI-DIR	Page 213
	O-Ring Type O-RING	Page 207



Banjo Elbow (High-Pressure Version)
Type FI-RSW-...-R-DK ■ Series L / S

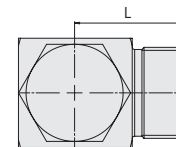
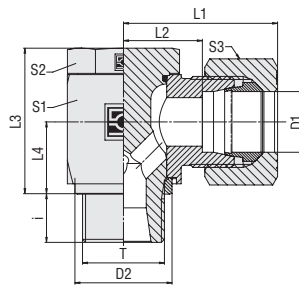

Whitworth Parallel Pipe Thread (BSPP)

External Metallic Sealing Ring

Ordering Codes

***FI-RSW*-10*L*R*-DK*-B*-W3*-MS**

* Banjo Elbow (High-Pressure Version) **FI-RSW**

* Outside Tube Diameter D1 (in mm) **-10**

* Series Light Series **L**
 Heavy Series **S**

* Thread Type Whitworth Parallel Pipe Thread (BSPP) **R**

If required, please indicate special sizes, e.g. R1/8!

* Seal Type External Metallic Sealing Ring **-DK**

* Seal Material NBR (Buna-N®) **-B**
 FKM (Viton®) **-V**
 EPDM **-E**

* Material Code Steel, zinc/nickel-plated **-W3**

Please contact STAUFF for alternative materials and surface finishings.

* Assembling / Kitting Fitting body only **—**

Fitting body supplied with cutting ring and union nut **-MS**

Fitting body supplied with soft-sealing cutting ring and union nut **-MSV**

Series	Tube OD (mm/in)	PB (mm/psi)	Dimensions (mm/in)										Weight (kg/lbs) ca. per 100 ²	Ordering Codes ³	
			Thread	T	D2	L	L1 ¹	L2	L3	L4	i	S1			S2
L	6	500	G 1/8	13	20	28	13	21	10,5	8	14	14	14	3,61	FI-RSW-06LR-DK-B-W3
	.24	7250		.51	.79	1.10	.51	.83	.41	.31	.55	.55	.55	7.94	
	8	500	G 1/4	17,8	21	29	14	27	13,5	10	19	19	17	7,93	FI-RSW-08LR-DK-B-W3
	.31	7250		.70	.83	1.14	.55	1.06	.53	.39	.75	.75	.67	17.44	
	10	500	G 1/4	17,8	22	30	15	27	13,5	10	19	19	19	8,15	FI-RSW-10LR-DK-B-W3
	.39	7250		.70	.87	1.18	.59	1.06	.53	.39	.75	.75	.75	17.93	
	12	400	G 3/8	22	24,5	32,5	17,5	32,5	16	12	24	22	22	13,75	FI-RSW-12LR-DK-B-W3
	.47	5800		.87	.96	1.28	.69	1.28	.63	.47	.94	.87	.87	30.24	
	15	400	G 1/2	26	27	35	21	43	19,5	14	30	27	27	25,80	FI-RSW-15LR-DK-B-W3
	.59	5800		1.02	1.06	1.38	.83	1.69	.77	.55	1.18	1.06	1.06	56.76	
	18	400	G 1/2	26	28	37	20,5	43	21,5	12	30	27	32	26,56	FI-RSW-18LR-DK-B-W3
	.71	5800		1.02	1.10	1.46	.81	1.69	.85	.47	1.18	1.06	1.26	58.44	
	22	250	G 3/4	32	34,5	43,5	27	48	24	16	36	32	36	43,25	FI-RSW-22LR-DK-B-W3
	.87	3625		1.26	1.36	1.71	1.06	1.89	.94	.63	1.42	1.26	1.42	95.14	
	28	250	G 1	39	39	48	31,5	59	30,5	18	46	41	41	83,60	FI-RSW-28LR-DK-B-W3
	1.10	3625		1.54	1.54	1.89	1.24	2.32	1.20	.71	1.81	1.61	1.61	183.92	
	35	250	G 1 1/4	49	46	57	35,5	70	35,5	20	55	50	50	140,80	FI-RSW-35LR-DK-B-W3
	1.38	3625		1.93	1.81	2.24	1.40	2.76	1.40	.79	2.17	1.97	1.97	309.76	
42	250	G 1 1/2	55	51	63	40	80	40,5	22	65	55	60	211,80	FI-RSW-42LR-DK-B-W3	
1.65	3625		2.17	2.01	2.48	1.57	3.15	1.59	.87	2.56	2.17	2.36	465.96		
S	6	500	G 1/4	17,8	23	31	16	27	13,5	10	19	19	17	8,36	FI-RSW-06SR-DK-B-W3
	.24	7250		.70	.91	1.22	.63	1.06	.53	.39	.75	.75	.67	18.39	
	8	500	G 1/4	17,8	23	31	16	27	13,5	10	19	19	19	8,62	FI-RSW-08SR-DK-B-W3
	.31	7250		.70	.91	1.22	.63	1.06	.53	.39	.75	.75	.75	18.96	
	10	500	G 3/8	22	25,5	34,5	18	32,5	16	10	24	22	22	14,57	FI-RSW-10SR-DK-B-W3
	.39	7250		.87	1.00	1.36	.71	1.28	.63	.39	.94	.87	.87	32.06	
	12	400	G 3/8	22	27	36	18	32,5	16	10	24	22	24	14,59	FI-RSW-12SR-DK-B-W3
	.47	5800		.87	1.06	1.42	.71	1.28	.63	.39	.94	.87	.94	32.09	
	14	400	G 1/2	26	30	40	22	41	19,5	14	30	27	27	26,55	FI-RSW-14SR-DK-B-W3
	.55	5800		1.02	1.18	1.57	.87	1.61	.77	.55	1.18	1.06	1.06	58.41	
	16	400	G 1/2	26	30	40	21,5	43	21,5	12	30	27	30	26,86	FI-RSW-16SR-DK-B-W3
	.63	5800		1.02	1.18	1.57	.85	1.69	.85	.47	1.18	1.06	1.18	59.10	
	20	315	G 3/4	32	36,5	47,5	26	48	24	16	36	32	36	44,88	FI-RSW-20SR-DK-B-W3
	.79	4568		1.26	1.44	1.87	1.02	1.89	.94	.63	1.42	1.26	1.42	98.74	
	25	250	G 1	39	43	55	31	59	30,5	18	46	41	46	87,00	FI-RSW-25SR-DK-B-W3
	.98	3625		1.54	1.69	2.17	1.22	2.32	1.20	.71	1.81	1.61	1.81	191.40	
	30	250	G 1 1/4	49	50	63	36,5	70	35,5	20	55	50	50	145,00	FI-RSW-30SR-DK-B-W3
	1.18	3625		1.93	1.97	2.48	1.44	2.76	1.40	.79	2.17	1.97	1.97	319.00	
38	250	G 1 1/2	55	57	72	41	80	40,5	22	65	55	60	223,40	FI-RSW-38SR-DK-B-W3	
1.50	3625		2.17	2.24	2.83	1.61	3.15	1.59	.87	2.56	2.17	2.36	491.48		

¹ Approximate dimension in assembled condition.

Port acc. to DIN 3852-2 (Form X) / ISO 1179-1

² Weight excluding cutting ring and union nut.

³ Standard scope of delivery: Fitting body only.

Standard seal material is NBR (Buna-N®).



For use with aggressive media and/or at elevated temperatures, please remove the O-ring from the groove located on the banjo bolt prior to installation.

Connecting Parts



Cutting Ring
 Type **FI-DS** Page 26



Soft-Sealing Cutting Ring
 Type **FI-WDDS** Page 27



Support Sleeve
 Type **FI-VH** Page 28



STAUFF Form Ring
 Type **FI-AR** Page 30



Union Nut
 Type **FI-M** Page 31



37° Flared Tube Fitting Set
 Type **FI-AB** Page 35

Spare Parts / Accessories



External Metallic Sealing Ring
 Type **FI-DKR** Page 212



O-Ring
 Type **O-RING** Page 207

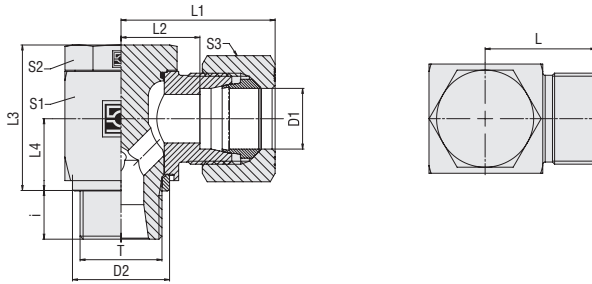

**Banjo Elbow (High-Pressure Version)
Type FI-RSW-...-M-DK ■ Series L / S**

External Metallic Sealing Ring
Metric Parallel Thread

Series	Tube OD (mm/in)	PB (bar/psi)	Dimensions (mm/in)	Dimensions													Weight (kg/lbs) ca. per 100 ²	Ordering Codes ³
				Thread	T	D2	L	L1 ¹	L2	L3	L4	i	S1	S2	S3			
L	6	500	M10x1	13	20	28	13	21	10	8	14	14	14	3,66	FI-RSW-06LM-DK-B-W3			
	.24	7250		.51	.79	1.10	.51	.83	.39	.31	.55	.55	.55	8.05				
	8	500	M12x1,5	17,8	21	29	14	27	13,5	10	19	19	17	7,70	FI-RSW-08LM-DK-B-W3			
	.31	7250		.70	.83	1.14	.55	1.06	.53	.39	.75	.75	.67	16.94				
	10	500	M14x1,5	17,8	22	30	15	27	13,5	10	19	19	19	8,21	FI-RSW-10LM-DK-B-W3			
	.39	7250		.70	.87	1.18	.59	1.06	.53	.39	.75	.75	.75	18.06				
	12	400	M16x1,5	21	24,5	32,5	17,5	32,5	16	10	24	22	22	13,72	FI-RSW-12LM-DK-B-W3			
	.47	5800		.83	.96	1.28	.69	1.28	.63	.39	.94	.87	.87	30.19				
	15	400	M18x1,5	23	27	35	20	37	18,5	10	27	24	27	17,73	FI-RSW-15LM-DK-B-W3			
	.59	5800		.91	1.06	1.38	.79	1.46	.73	.39	1.06	.94	1.06	39.00				
	18	400	M22x1,5	27	28	37	20,5	43	21,5	12	30	27	32	27,01	FI-RSW-18LM-DK-B-W3			
	.71	5800		1.06	1.10	1.46	.81	1.69	.85	.47	1.18	1.06	1.26	59.41				
	22	250	M26x1,5	31	34,5	43,5	27	48	24	16	36	32	36	42,27	FI-RSW-22LM-DK-B-W3			
	.87	3625		1.22	1.36	1.71	1.06	1.89	.94	.63	1.42	1.26	1.42	93.00				
	28	250	M33x2	39	39	48	31,5	59	30,5	18	46	41	41	83,30	FI-RSW-28LM-DK-B-W3			
	1.10	3625		1.54	1.54	1.89	1.24	2.32	1.20	.71	1.81	1.61	1.61	183.26				
	35	250	M42x2	49	46	57	35,5	70	35,5	20	55	50	50	146,51	FI-RSW-35LM-DK-B-W3			
	1.38	3625		1.93	1.81	2.24	1.40	2.76	1.40	.79	2.17	1.97	1.97	322.31				
	42	250	M48x2	55	51	63	40	80	40,5	22	65	55	60	226,97	FI-RSW-42LM-DK-B-W3			
	1.65	3625		2.17	2.01	2.48	1.57	3.15	1.59	.87	2.56	2.17	2.36	499.34				
S	6	500	M12x1,5	17,8	23	31	16	27	13,5	10	19	19	17	10,09	FI-RSW-06SM-DK-B-W3			
	.24	7250		.70	.91	1.22	.63	1.06	.53	.39	.75	.75	.67	22.20				
	8	500	M14x1,5	17,8	23	31	16	27	13,5	10	19	19	19	8,69	FI-RSW-08SM-DK-B-W3			
	.31	7250		.70	.91	1.22	.63	1.06	.53	.39	.75	.75	.75	19.12				
	10	500	M16x1,5	21	25,5	34,5	18	32,5	16	10	24	22	22	14,46	FI-RSW-10SM-DK-B-W3			
	.39	7250		.83	1.00	1.36	.71	1.28	.63	.39	.94	.87	.87	31.81				
	12	400	M18x1,5	23	27	36	19,5	37	18,5	10	27	24	24	19,33	FI-RSW-12SM-DK-B-W3			
	.47	5800		.91	1.06	1.42	.77	1.46	.73	.39	1.06	.94	.94	42.52				
	14	400	M20x1,5	25	30	40	22	41	19,5	12	30	27	27	28,76	FI-RSW-14SM-DK-B-W3			
	.55	5800		.98	1.18	1.57	.87	1.61	.77	.47	1.18	1.06	1.06	63.27				
	16	400	M22x1,5	27	30	40	21,5	43	21,5	12	30	27	30	27,40	FI-RSW-16SM-DK-B-W3			
	.63	5800		1.06	1.18	1.57	.85	1.69	.85	.47	1.18	1.06	1.18	60.28				
	20	315	M27x2	32	36,5	47,5	26	48	24	16	36	32	36	0,00	FI-RSW-20SM-DK-B-W3			
	.79	4568		1.26	1.44	1.87	1.02	1.89	.94	.63	1.42	1.26	1.42	.00				
	25	250	M33x2	39	43	55	31	59	30,5	18	46	41	46	30,63	FI-RSW-25SM-DK-B-W3			
.98	3625		1.54	1.69	2.17	1.22	2.32	1.20	.71	1.81	1.61	1.81	67.39					
30	250	M42x2	49	50	63	36,5	70	35,5	20	55	50	50	149,83	FI-RSW-30SM-DK-B-W3				
1.18	3625		1.93	1.97	2.48	1.44	2.76	1.40	.79	2.17	1.97	1.97	329.62					
38	250	M48x2	55	57	72	41	80	40,5	22	65	55	60	236,07	FI-RSW-38SM-DK-B-W3				
1.50	3625		2.17	2.24	2.83	1.61	3.15	1.59	.87	2.56	2.17	2.36	519.36					

¹ Approximate dimension in assembled condition.

Port acc. to DIN 3852-1 (Form X) / ISO 9974-1

² Weight excluding cutting ring and union nut.

³ Standard scope of delivery: Fitting body only.

Standard seal material is NBR (Buna-N®).



For use with aggressive media and/or at elevated temperatures, please remove the o-ring from the groove located on the banjo bolt prior to installation.

Ordering Codes
***FI-RSW*-10*L*M*-DK*-B*-W3*-MS**

 * Banjo Elbow (High-Pressure Version) **FI-RSW**

 * Outside Tube Diameter D1 (in mm) **-10**

 * Series Light Series **L**
Heavy Series **S**

 * Thread Type Metric Parallel Thread **M**

If required, please indicate special sizes, e.g. M12x1.5!

 * Seal Type External Metallic Sealing Ring **-DK**

 * Seal Material NBR (Buna-N®) **-B**
FKM (Viton®) **-V**
EPDM **-E**

 * Material Code Steel, zinc/nickel-plated **-W3**

Please contact STAUFF for alternative materials and surface finishings.

 * Assembling / Kitting Fitting body only **—**

 Fitting body supplied with cutting ring and union nut **-MS**

 Fitting body supplied with soft-sealing cutting ring and union nut **-MSV**
Connecting Parts

	Cutting Ring Type FI-DS	Page 26
	Soft-Sealing Cutting Ring Type FI-WDDS	Page 27
	Support Sleeve Type FI-VH	Page 28
	STAUFF Form Ring Type FI-AR	Page 30
	Union Nut Type FI-M	Page 31
	37° Flared Tube Fitting Set Type FI-AB	Page 35

Spare Parts / Accessories

	External Metallic Sealing Ring Type FI-DKR	Page 212
	O-Ring Type O-RING	Page 207



Banjo Elbow (High-Pressure Version)
Type FI-RSW-...-R-WD ▪ Series L / S

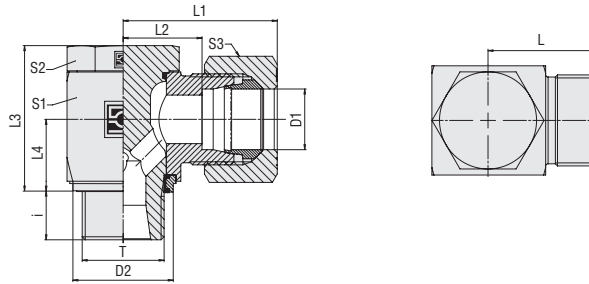

Whitworth Parallel Pipe Thread (BSPP)

Retaining Ring with Captive Seal

Ordering Codes

***FI-RSW*-10*L*R*-WD*-B*-W3*-MS**

* Banjo Elbow (High-Pressure Version) **FI-RSW**

* Outside Tube Diameter D1 (in mm) **-10**

* Series Light Series **L**
 Heavy Series **S**

* Thread Type Whitworth Parallel Pipe Thread (BSPP) **R**

If required, please indicate special sizes, e.g. R1/8!

* Seal Type Retaining Ring with Captive Seal **-WD**

* Seal Material NBR (Buna-N®) **-B**
 FKM (Viton®) **-V**
 EPDM **-E**

* Material Code Steel, zinc/nickel-plated **-W3**

Please contact STAUFF for alternative materials and surface finishings.

* Assembling / Kitting Fitting body only **—**
 Fitting body supplied with cutting ring and union nut **-MS**
 Fitting body supplied with soft-sealing cutting ring and union nut **-MSV**

Series	Tube OD (mm/in)	PB (°B/PSI)	Dimensions (mm/in)											Weight (kg/lbs) ca. per 100 ²	Ordering Codes ³
			Thread	T	D2	L	L1 ¹	L2	L3	L4	i	S1	S2		
L	6	500	G 1/8	14,9	20	28	13	21	10,5	8	14	14	14	3,65	FI-RSW-06LR-WD-B-W3
	.24	7250		.59	.79	1.10	.51	.83	.41	.31	.55	.55	.55	8.04	
	8	500	G 1/4	18,9	21	29	14	27	13,5	10	19	19	17	7,92	FI-RSW-08LR-WD-B-W3
	.31	7250		.74	.83	1.14	.55	1.06	.53	.39	.75	.75	.67	17.43	
	10	500	G 1/4	18,9	22	30	15	27	13,5	10	19	19	19	8,16	FI-RSW-10LR-WD-B-W3
	.39	7250		.74	.87	1.18	.59	1.06	.53	.39	.75	.75	.75	17.95	
	12	400	G 3/8	21,9	24,5	32,5	17,5	32,5	16	12	24	22	22	13,94	FI-RSW-12LR-WD-B-W3
	.47	5800		.86	.96	1.28	.69	1.28	.63	.47	.94	.87	.87	30.67	
	15	400	G 1/2	26,9	27	35	21	43	19,5	14	30	27	27	26,03	FI-RSW-15LR-WD-B-W3
	.59	5800		1.06	1.06	1.38	.83	1.69	.77	.55	1.18	1.06	1.06	57.26	
	18	400	G 1/2	26,9	28	37	20,5	43	21,5	12	30	27	32	26,75	FI-RSW-18LR-WD-B-W3
	.71	5800		1.06	1.10	1.46	.81	1.69	.85	.47	1.18	1.06	1.26	58.86	
	22	250	G 3/4	32,9	34,5	43,5	27	48	24	16	36	32	36	42,37	FI-RSW-22LR-WD-B-W3
	.87	3625		1.30	1.36	1.71	1.06	1.89	.94	.63	1.42	1.26	1.42	93.21	
	28	250	G 1	39,9	39	48	31,5	59	30,5	18	46	41	41	84,00	FI-RSW-28LR-WD-B-W3
	1.10	3625		1.57	1.54	1.89	1.24	2.32	1.20	.71	1.81	1.61	1.61	184.80	
	35	250	G 1 1/4	49,9	46	57	35,5	70	35,5	20	55	50	50	140,00	FI-RSW-35LR-WD-B-W3
	1.38	3625		1.96	1.81	2.24	1.40	2.76	1.40	.79	2.17	1.97	1.97	308.00	
42	250	G 1 1/2	55,9	51	63	40	80	40,5	22	65	55	60	214,30	FI-RSW-42LR-WD-B-W3	
1.65	3625		2.20	2.01	2.48	1.57	3.15	1.59	.87	2.56	2.17	2.36	471.46		
S	6	500	G 1/4	18,9	23	31	16	27	13,5	10	19	19	17	8,36	FI-RSW-06SR-WD-B-W3
	.24	7250		.74	.91	1.22	.63	1.06	.53	.39	.75	.75	.67	18.40	
	8	500	G 1/4	18,9	23	31	16	27	13,5	10	19	19	19	8,63	FI-RSW-08SR-WD-B-W3
	.31	7250		.74	.91	1.22	.63	1.06	.53	.39	.75	.75	.75	18.99	
	10	500	G 3/8	21,9	25,5	34,5	18	32,5	16	10	24	22	22	14,36	FI-RSW-10SR-WD-B-W3
	.39	7250		.86	1.00	1.36	.71	1.28	.63	.39	.94	.87	.87	31.60	
	12	400	G 3/8	21,9	27	36	18	32,5	16	10	24	22	24	14,86	FI-RSW-12SR-WD-B-W3
	.47	5800		.86	1.06	1.42	.71	1.28	.63	.39	.94	.87	.94	32.70	
	14	400	G 1/2	26,9	30	40	22	41	19,5	14	30	27	27	26,74	FI-RSW-14SR-WD-B-W3
	.55	5800		1.06	1.18	1.57	.87	1.61	.77	.55	1.18	1.06	1.06	58.83	
	16	400	G 1/2	26,9	30	40	21,5	43	21,5	12	30	27	30	27,23	FI-RSW-16SR-WD-B-W3
	.63	5800		1.06	1.18	1.57	.85	1.69	.85	.47	1.18	1.06	1.18	59.91	
	20	315	G 3/4	32,9	36,5	47,5	26	48	24	16	36	32	36	44,33	FI-RSW-20SR-WD-B-W3
	.79	4568		1.30	1.44	1.87	1.02	1.89	.94	.63	1.42	1.26	1.42	97.53	
	25	250	G 1	39,9	43	55	31	59	30,5	18	46	41	46	86,90	FI-RSW-25SR-WD-B-W3
	.98	3625		1.57	1.69	2.17	1.22	2.32	1.20	.71	1.81	1.61	1.81	191.18	
	30	250	G 1 1/4	49,9	50	63	36,5	70	35,5	20	55	50	50	144,70	FI-RSW-30SR-WD-B-W3
	1.18	3625		1.96	1.97	2.48	1.44	2.76	1.40	.79	2.17	1.97	1.97	318.34	
38	250	G 1 1/2	55,9	57	72	41	80	40,5	22	65	55	60	223,60	FI-RSW-38SR-WD-B-W3	
1.50	3625		2.20	2.24	2.83	1.61	3.15	1.59	.87	2.56	2.17	2.36	491.92		

¹ Approximate dimension in assembled condition.

Port acc. to DIN 3852-2 (Form X) / ISO 1179-1

² Weight excluding cutting ring and union nut.

³ Standard scope of delivery: Fitting body only.

Standard seal material is NBR (Buna-N®).

Connecting Parts

	Cutting Ring Type FI-DS	Page 26
	Soft-Sealing Cutting Ring Type FI-WDDS	Page 27
	Support Sleeve Type FI-VH	Page 28
	STAUFF Form Ring Type FI-AR	Page 30
	Union Nut Type FI-M	Page 31
	37° Flared Tube Fitting Set Type FI-AB	Page 35

Spare Parts / Accessories

	Retaining Ring with Captive Seal Type FI-DIR	Page 213
	O-Ring Type O-RING	Page 207

K

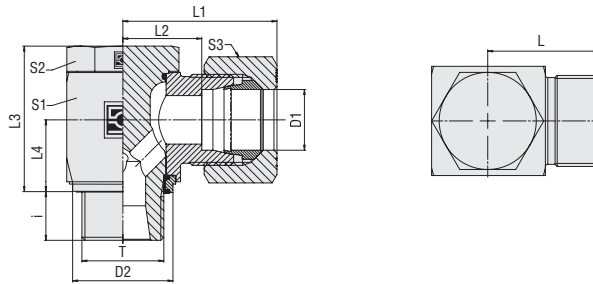

**Banjo Elbow (High-Pressure Version)
Type FI-RSW-...-M-WD ■ Series L / S**

Retaining Ring with Captive Seal
Metric Parallel Thread

Series	Tube OD (mm/in)	PB (bar/psi)	Dimensions (mm/in)													Weight (kg/lbs) ca. per 100 ²	Ordering Codes ³
			D1	Thread	T	D2	L	L1 ¹	L2	L3	L4	i	S1	S2	S3		
L	6	500	M10x1	13	20	28	13	21	10	8	14	14	14	3,68	FI-RSW-06LM-WD-B-W3		
	.24	7250		.51	.79	1.10	.51	.83	.39	.31	.55	.55	.55	8.09			
	8	500	M12x1,5	17,8	21	29	14	27	13,5	10	19	19	17	7,68	FI-RSW-08LM-WD-B-W3		
	.31	7250		.70	.83	1.14	.55	1.06	.53	.39	.75	.75	.67	16.90			
	10	500	M14x1,5	17,8	22	30	15	27	13,5	10	19	19	19	8,28	FI-RSW-10LM-WD-B-W3		
	.39	7250		.70	.87	1.18	.59	1.06	.53	.39	.75	.75	.75	18.22			
	12	400	M16x1,5	21	24,5	32,5	17,5	32,5	16	10	24	22	22	13,60	FI-RSW-12LM-WD-B-W3		
	.47	5800		.83	.96	1.28	.69	1.28	.63	.39	.94	.87	.87	29.92			
	15	400	M18x1,5	23	27	35	20	37	18,5	10	27	24	27	19,21	FI-RSW-15LM-WD-B-W3		
	.59	5800		.91	1.06	1.38	.79	1.46	.73	.39	1.06	.94	1.06	42.26			
	18	400	M22x1,5	27	28	37	20,5	43	21,5	12	30	27	32	27,12	FI-RSW-18LM-WD-B-W3		
	.71	5800		1.06	1.10	1.46	.81	1.69	.85	.47	1.18	1.06	1.26	59.67			
	22	250	M26x1,5	31	34,5	43,5	27	48	24	16	36	32	36	42,64	FI-RSW-22LM-WD-B-W3		
	.87	3625		1.22	1.36	1.71	1.06	1.89	.94	.63	1.42	1.26	1.42	93.82			
	28	250	M33x2	39	39	48	31,5	59	30,5	18	46	41	41	95,43	FI-RSW-28LM-WD-B-W3		
	1.10	3625		1.54	1.54	1.89	1.24	2.32	1.20	.71	1.81	1.61	1.61	209.95			
	35	250	M42x2	49	46	57	35,5	70	35,5	20	55	50	50	146,83	FI-RSW-35LM-WD-B-W3		
	1.38	3625		1.93	1.81	2.24	1.40	2.76	1.40	.79	2.17	1.97	1.97	323.03			
	42	250	M48x2	55	51	63	40	80	40,5	22	65	55	60	221,72	FI-RSW-42LM-WD-B-W3		
	1.65	3625		2.17	2.01	2.48	1.57	3.15	1.59	.87	2.56	2.17	2.36	487.79			
S	6	500	M12x1,5	17,8	23	31	16	27	13,5	10	19	19	17	8,10	FI-RSW-06SM-WD-B-W3		
	.24	7250		.70	.91	1.22	.63	1.06	.53	.39	.75	.75	.67	17.82			
	8	500	M14x1,5	17,8	23	31	16	27	13,5	10	19	19	19	8,80	FI-RSW-08SM-WD-B-W3		
	.31	7250		.70	.91	1.22	.63	1.06	.53	.39	.75	.75	.75	19.36			
	10	500	M16x1,5	21	25,5	34,5	18	32,5	16	10	24	22	22	14,19	FI-RSW-10SM-WD-B-W3		
	.39	7250		.83	1.00	1.36	.71	1.28	.63	.39	.94	.87	.87	31.21			
	12	400	M18x1,5	23	27	36	19,5	37	18,5	10	27	24	24	19,53	FI-RSW-12SM-WD-B-W3		
	.47	5800		.91	1.06	1.42	.77	1.46	.73	.39	1.06	.94	.94	42.97			
	14	400	M20x1,5	25	30	40	22	41	19,5	12	30	27	27	29,38	FI-RSW-14SM-WD-B-W3		
	.55	5800		.98	1.18	1.57	.87	1.61	.77	.47	1.18	1.06	1.06	64.63			
	16	400	M22x1,5	27	30	40	21,5	43	21,5	12	30	27	30	27,53	FI-RSW-16SM-WD-B-W3		
	.63	5800		1.06	1.18	1.57	.85	1.69	.85	.47	1.18	1.06	1.18	60.56			
	20	315	M27x2	32	36,5	47,5	26	48	24	16	36	32	36	44,30	FI-RSW-20SM-WD-B-W3		
	.79	4568		1.26	1.44	1.87	1.02	1.89	.94	.63	1.42	1.26	1.42	97.47			
	25	250	M33x2	39	43	55	31	59	30,5	18	46	41	46	224,50	FI-RSW-25SM-WD-B-W3		
	.98	3625		1.54	1.69	2.17	1.22	2.32	1.20	.71	1.81	1.61	1.81	493.90			
	30	250	M42x2	49	50	63	36,5	70	35,5	20	55	50	50	150,16	FI-RSW-30SM-WD-B-W3		
	1.18	3625		1.93	1.97	2.48	1.44	2.76	1.40	.79	2.17	1.97	1.97	330.36			
38	250	M48x2	55	57	72	41	80	40,5	22	65	55	60	224,90	FI-RSW-38SM-WD-B-W3			
1.50	3625		2.17	2.24	2.83	1.61	3.15	1.59	.87	2.56	2.17	2.36	494.78				

¹ Approximate dimension in assembled condition.

Port acc. to DIN 3852-1 (Form X) / ISO 9974-1

² Weight excluding cutting ring and union nut.

³ Standard scope of delivery: Fitting body only.

Standard seal material is NBR (Buna-N®).

Ordering Codes
***FI-RSW*-10*L*M*-WD*-B*-W3*-MS**

 * Banjo Elbow (High-Pressure Version) **FI-RSW**

 * Outside Tube Diameter D1 (in mm) **-10**

 * Series **L**
Light Series
S
Heavy Series

 * Thread Type **M**
Metric Parallel Thread

If required, please indicate special sizes, e.g. M12x1.5!

 * Seal Type **WD**
Retaining Ring with Captive Seal

 * Seal Material **-B**
NBR (Buna-N®)
-V
FKM (Viton®)
-E
EPDM

 * Material Code **-W3**
Steel, zinc/nickel-plated

Please contact STAUFF for alternative materials and surface finishings.

 * Assembling / Kitting **—**
Fitting body only

-MS
Fitting body supplied with cutting ring and union nut

-MSV
Fitting body supplied with soft-sealing cutting ring and union nut

Connecting Parts

	Cutting Ring Type FI-DS	Page 26
	Soft-Sealing Cutting Ring Type FI-WDDS	Page 27
	Support Sleeve Type FI-VH	Page 28
	STAUFF Form Ring Type FI-AR	Page 30
	Union Nut Type FI-M	Page 31
	37° Flared Tube Fitting Set Type FI-AB	Page 35

Spare Parts / Accessories

	Retaining Ring with Captive Seal Type FI-DIR	Page 213
	O-Ring Type O-RING	Page 207



Banjo Tee (High-Pressure Version)
Type FI-RST-...-R-DK • Series L / S

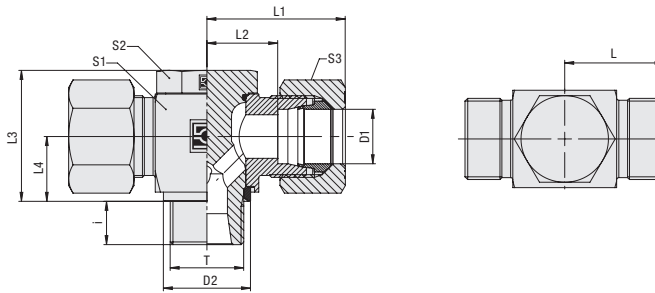

Whitworth Parallel Pipe Thread (BSPP)

External Metallic Sealing Ring

Ordering Codes

***FI-RST*-10*L*R*-DK*-B*-W3*-MS**

* Banjo Tee (High-Pressure Version) **FI-RST**

* Outside Tube Diameter D1 (in mm) **-10**

* Series Light Series **L**
 Heavy Series **S**

* Thread Type Whitworth Parallel Pipe Thread (BSPP) **R**

If required, please indicate special sizes, e.g. R1/8!

* Seal Type External Metallic Sealing Ring **-DK**

* Seal Material NBR (Buna-N®) **-B**
 FKM (Viton®) **-V**
 EPDM **-E**

* Material Code Steel, zinc/nickel-plated **-W3**

Please contact STAUFF for alternative materials and surface finishings.

* Assembling / Kitting Fitting body only **—**

Fitting body supplied with cutting ring and union nut **-MS**

Fitting body supplied with soft-sealing cutting ring and union nut **-MSV**

Series	Tube OD (mm/in)	PB (mm/psi)	Dimensions										Weight (kg/lbs) ca. per 100 ²	Ordering Codes ³	
			Thread	T	D2	L	L1 ¹	L2	L3	L4	i	S1			S2
L	6	500	G 1/8	13	20	28	13	21	10,5	8	14	14	14	4,57	FI-RST-06LR-DK-B-W3
	.24	7250		.51	.79	1.10	.51	.83	.41	.31	.55	.55	.55	10,04	
	8	500	G 1/4	17,8	21	29	14	27	13,5	10	19	19	17	8,60	FI-RST-08LR-DK-B-W3
	.31	7250		.70	.83	1.14	.55	1.06	.53	.39	.75	.75	.67	18,92	
	10	500	G 1/4	17,8	22	30	15	27	13,5	10	19	19	19	8,93	FI-RST-10LR-DK-B-W3
	.39	7250		.70	.87	1.18	.59	1.06	.53	.39	.75	.75	.75	19,65	
	12	400	G 3/8	22	24,5	32,5	17,5	32,5	16	12	24	22	22	15,04	FI-RST-12LR-DK-B-W3
	.47	5800		.87	.96	1.28	.69	1.28	.63	.47	.94	.87	.87	33,08	
	15	400	G 1/2	26	27	35	21	43	19,5	14	30	27	27	30,15	FI-RST-15LR-DK-B-W3
	.59	5800		1.02	1.06	1.38	.83	1.69	.77	.55	1.18	1.06	1.06	66,33	
	18	400	G 1/2	26	28	37	20,5	43	21,5	12	30	27	32	31,25	FI-RST-18LR-DK-B-W3
	.71	5800		1.02	1.10	1.46	.81	1.69	.85	.47	1.18	1.06	1.26	68,75	
	22	250	G 3/4	32	34,5	43,5	27	48	24	16	36	32	36	46,23	FI-RST-22LR-DK-B-W3
	.87	3625		1.26	1.36	1.71	1.06	1.89	.94	.63	1.42	1.26	1.42	101,70	
	28	250	G 1	39	39	48	31,5	59	30,5	18	46	41	41	80,19	FI-RST-28LR-DK-B-W3
	1.10	3625		1.54	1.54	1.89	1.24	2.32	1.20	.71	1.81	1.61	1.61	176,41	
	35	250	G 1 1/4	49	46	57	35,5	70	35,5	20	55	50	50	145,46	FI-RST-35LR-DK-B-W3
	1.38	3625		1.93	1.81	2.24	1.40	2.76	1.40	.79	2.17	1.97	1.97	320,00	
42	250	G 1 1/2	55	51	63	40	80	40,5	22	65	55	60	217,14	FI-RST-42LR-DK-B-W3	
1.65	3625		2.17	2.01	2.48	1.57	3.15	1.59	.87	2.56	2.17	2.36	477,71		
S	6	500	G 1/4	17,8	23	31	16	27	13,5	10	19	19	17	9,48	FI-RST-06SR-DK-B-W3
	.24	7250		.70	.91	1.22	.63	1.06	.53	.39	.75	.75	.67	20,86	
	8	500	G 1/4	17,8	23	31	16	27	13,5	10	19	19	19	9,97	FI-RST-08SR-DK-B-W3
	.31	7250		.70	.91	1.22	.63	1.06	.53	.39	.75	.75	.75	21,93	
	10	500	G 3/8	22	25,5	34,5	18	32,5	16	10	24	22	22	19,10	FI-RST-10SR-DK-B-W3
	.39	7250		.87	1.00	1.36	.71	1.28	.63	.39	.94	.87	.87	42,02	
	12	400	G 3/8	22	27	36	18	32,5	16	10	24	22	24	16,38	FI-RST-12SR-DK-B-W3
	.47	5800		.87	1.06	1.42	.71	1.28	.63	.39	.94	.87	.94	36,03	
	14	400	G 1/2	26	30	40	22	41	19,5	14	30	27	27	91,00	FI-RST-14SR-DK-B-W3
	.55	5800		1.02	1.18	1.57	.87	1.61	.77	.55	1.18	1.06	1.06	200,20	
	16	400	G 1/2	26	30	40	21,5	43	21,5	12	30	27	30	31,85	FI-RST-16SR-DK-B-W3
	.63	5800		1.02	1.18	1.57	.85	1.69	.85	.47	1.18	1.06	1.18	70,08	
	20	315	G 3/4	32	36,5	47,5	26	48	24	16	36	32	36	48,45	FI-RST-20SR-DK-B-W3
	.79	4568		1.26	1.44	1.87	1.02	1.89	.94	.63	1.42	1.26	1.42	106,58	
	25	250	G 1	39	43	55	31	59	30,5	18	46	41	46	93,55	FI-RST-25SR-DK-B-W3
	.98	3625		1.54	1.69	2.17	1.22	2.32	1.20	.71	1.81	1.61	1.81	205,80	
	30	250	G 1 1/4	49	50	63	36,5	70	35,5	20	55	50	50	153,59	FI-RST-30SR-DK-B-W3
	1.18	3625		1.93	1.97	2.48	1.44	2.76	1.40	.79	2.17	1.97	1.97	337,91	
38	250	G 1 1/2	55	57	72	41	80	40,5	22	65	55	60	236,22	FI-RST-38SR-DK-B-W3	
1.50	3625		2.17	2.24	2.83	1.61	3.15	1.59	.87	2.56	2.17	2.36	519,69		

¹ Approximate dimension in assembled condition.

Port acc. to DIN 3852-2 (Form X) / ISO 1179-1

² Weight excluding cutting ring and union nut.

³ Standard scope of delivery: Fitting body only.

Standard seal material is NBR (Buna-N®).



For use with aggressive media and/or at elevated temperatures, please remove the O-ring from the groove located on the banjo bolt prior to installation.

Connecting Parts

Cutting Ring Type **FI-DS** Page 26

Soft-Sealing Cutting Ring Type **FI-WDDS** Page 27

Support Sleeve Type **FI-VH** Page 28

STAUFF Form Ring Type **FI-AR** Page 30

Union Nut Type **FI-M** Page 31

37° Flared Tube Fitting Set Type **FI-AB** Page 35

Spare Parts / Accessories

External Metallic Sealing Ring Type **FI-DKR** Page 212

O-Ring Type **O-RING** Page 207

K

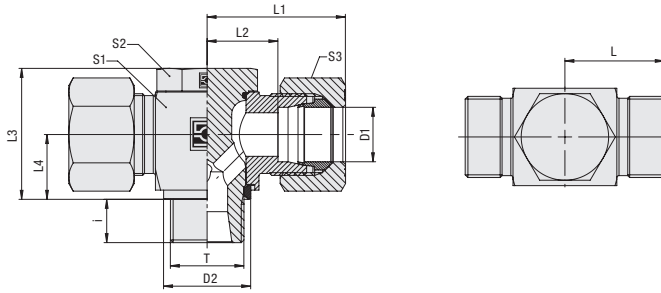

**Banjo Tee (High-Pressure Version)
Type FI-RST-...-M-DK ■ Series L / S**

External Metallic Sealing Ring
Metric Parallel Thread

Series	Tube OD (mm/in)	PB (bar/psi)	Dimensions (mm/in)	Dimensions													Weight (kg/lbs) ca. per 100 ²	Ordering Codes ³
				Thread	T	D2	L	L1 ¹	L2	L3	L4	i	S1	S2	S3			
L	6	500	M10x1	13	20	28	13	21	10	8	14	14	14	4,59	FI-RST-06LM-DK-B-W3			
	.24	7250		.51	.79	1.10	.51	.83	.39	.31	.55	.55	.55	10.10				
	8	500	M12x1,5	17,8	21	29	14	27	13,5	10	19	19	17	9,66	FI-RST-08LM-DK-B-W3			
	.31	7250		.70	.83	1.14	.55	1.06	.53	.39	.75	.75	.67	21.25				
	10	500	M14x1,5	17,8	22	30	15	27	13,5	10	19	19	19	11,05	FI-RST-10LM-DK-B-W3			
	.39	7250		.70	.87	1.18	.59	1.06	.53	.39	.75	.75	.75	24.30				
	12	400	M16x1,5	21	24,5	32,5	17,5	32,5	16	10	24	22	22	14,71	FI-RST-12LM-DK-B-W3			
	.47	5800		.83	.96	1.28	.69	1.28	.63	.39	.94	.87	.87	32.35				
	15	400	M18x1,5	23	27	35	20	37	18,5	10	27	24	27	10,80	FI-RST-15LM-DK-B-W3			
	.59	5800		.91	1.06	1.38	.79	1.46	.73	.39	1.06	.94	1.06	23.76				
	18	400	M22x1,5	27	28	37	20,5	43	21,5	12	30	27	32	31,81	FI-RST-18LM-DK-B-W3			
	.71	5800		1.06	1.10	1.46	.81	1.69	.85	.47	1.18	1.06	1.26	69.97				
	22	250	M26x1,5	31	34,5	43,5	27	48	24	16	36	32	36	44,90	FI-RST-22LM-DK-B-W3			
	.87	3625		1.22	1.36	1.71	1.06	1.89	.94	.63	1.42	1.26	1.42	98.78				
	28	250	M33x2	39	39	48	31,5	59	30,5	18	46	41	41	85,11	FI-RST-28LM-DK-B-W3			
	1.10	3625		1.54	1.54	1.89	1.24	2.32	1.20	.71	1.81	1.61	1.61	187.23				
	35	250	M42x2	49	46	57	35,5	70	35,5	20	55	50	50	145,36	FI-RST-35LM-DK-B-W3			
	1.38	3625		1.93	1.81	2.24	1.40	2.76	1.40	.79	2.17	1.97	1.97	319.78				
	42	250	M48x2	55	51	63	40	80	40,5	22	65	55	60	218,24	FI-RST-42LM-DK-B-W3			
	1.65	3625		2.17	2.01	2.48	1.57	3.15	1.59	.87	2.56	2.17	2.36	480.13				
S	6	500	M12x1,5	17,8	23	31	16	27	13,5	10	19	19	17	11,23	FI-RST-06SM-DK-B-W3			
	.24	7250		.70	.91	1.22	.63	1.06	.53	.39	.75	.75	.67	24.71				
	8	500	M14x1,5	17,8	23	31	16	27	13,5	10	19	19	19	12,02	FI-RST-08SM-DK-B-W3			
	.31	7250		.70	.91	1.22	.63	1.06	.53	.39	.75	.75	.75	26.45				
	10	500	M16x1,5	21	25,5	34,5	18	32,5	16	10	24	22	22	19,01	FI-RST-10SM-DK-B-W3			
	.39	7250		.83	1.00	1.36	.71	1.28	.63	.39	.94	.87	.87	41.81				
	12	400	M18x1,5	23	27	36	19,5	37	18,5	10	27	24	24	21,32	FI-RST-12SM-DK-B-W3			
	.47	5800		.91	1.06	1.42	.77	1.46	.73	.39	1.06	.94	.94	46.90				
	14	400	M20x1,5	25	30	40	22	41	19,5	12	30	27	27	30,96	FI-RST-14SM-DK-B-W3			
	.55	5800		.98	1.18	1.57	.87	1.61	.77	.47	1.18	1.06	1.06	68.11				
	16	400	M22x1,5	27	30	40	21,5	43	21,5	12	30	27	30	32,41	FI-RST-16SM-DK-B-W3			
	.63	5800		1.06	1.18	1.57	.85	1.69	.85	.47	1.18	1.06	1.18	71.29				
	20	315	M27x2	32	36,5	47,5	26	48	24	16	36	32	36	16,50	FI-RST-20SM-DK-B-W3			
	.79	4568		1.26	1.44	1.87	1.02	1.89	.94	.63	1.42	1.26	1.42	36.29				
	25	250	M33x2	39	43	55	31	59	30,5	18	46	41	46	93,47	FI-RST-25SM-DK-B-W3			
.98	3625		1.54	1.69	2.17	1.22	2.32	1.20	.71	1.81	1.61	1.81	205.62					
30	250	M42x2	49	50	63	36,5	70	35,5	20	55	50	50	153,16	FI-RST-30SM-DK-B-W3				
1.18	3625		1.93	1.97	2.48	1.44	2.76	1.40	.79	2.17	1.97	1.97	336.94					
38	250	M48x2	55	57	72	41	80	40,5	22	65	55	60	237,04	FI-RST-38SM-DK-B-W3				
1.50	3625		2.17	2.24	2.83	1.61	3.15	1.59	.87	2.56	2.17	2.36	521.49					

¹ Approximate dimension in assembled condition.

Port acc. to DIN 3852-1 (Form X) / ISO 9974-1

² Weight excluding cutting ring and union nut.

³ Standard scope of delivery: Fitting body only.

Standard seal material is NBR (Buna-N®).



For use with aggressive media and/or at elevated temperatures, please remove the o-ring from the groove located on the banjo bolt prior to installation.

Ordering Codes
***FI-RST*-10*L*M*-DK*-B*-W3*-MS**

 * Banjo Tee (High-Pressure Version) **FI-RST**

 * Outside Tube Diameter D1 (in mm) **-10**

 * Series Light Series **L**
Heavy Series **S**

 * Thread Type Metric Parallel Thread **M**

If required, please indicate special sizes, e.g. M12x1.5!

 * Seal Type External Metallic Sealing Ring **-DK**

 * Seal Material NBR (Buna-N®) **-B**
FKM (Viton®) **-V**
EPDM **-E**

 * Material Code Steel, zinc/nickel-plated **-W3**

Please contact STAUFF for alternative materials and surface finishings.

 * Assembling / Kitting Fitting body only **—**

 Fitting body supplied with cutting ring and union nut **-MS**

 Fitting body supplied with soft-sealing cutting ring and union nut **-MSV**
Connecting Parts

	Cutting Ring Type FI-DS	Page 26
	Soft-Sealing Cutting Ring Type FI-WDDS	Page 27
	Support Sleeve Type FI-VH	Page 28
	STAUFF Form Ring Type FI-AR	Page 30
	Union Nut Type FI-M	Page 31
	37° Flared Tube Fitting Set Type FI-AB	Page 35

Spare Parts / Accessories

	External Metallic Sealing Ring Type FI-DKR	Page 212
	O-Ring Type O-RING	Page 207



Banjo Tee (High-Pressure Version)
Type FI-RST-...-R-WD • Series L / S

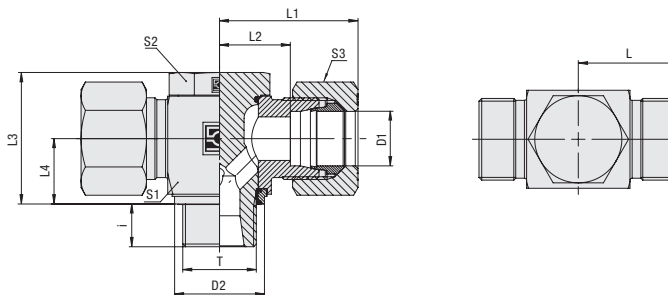

Whitworth Parallel Pipe Thread (BSPP)

Retaining Ring with Captive Seal

Ordering Codes

***FI-RST*-10*L*R*-WD*-B*-W3*-MS**

* Banjo Tee (High-Pressure Version) **FI-RST**

* Outside Tube Diameter D1 (in mm) **-10**

* Series Light Series **L**
 Heavy Series **S**

* Thread Type Whitworth Parallel Pipe Thread (BSPP) **R**

If required, please indicate special sizes, e.g. R1/8!

* Seal Type Retaining Ring with Captive Seal **-WD**

* Seal Material NBR (Buna-N®) **-B**
 FKM (Viton®) **-V**
 EPDM **-E**

* Material Code Steel, zinc/nickel-plated **-W3**

Please contact STAUFF for alternative materials and surface finishings.

* Assembling / Kitting Fitting body only **—**

Fitting body supplied with cutting ring and union nut **-MS**

Fitting body supplied with soft-sealing cutting ring and union nut **-MSV**

K

Series	Tube OD (mm/in)	PB (mm/psi)	Dimensions										Weight (kg/lbs) ca. per 100 ²	Ordering Codes ³	
			Thread	T	D2	L	L1 ¹	L2	L3	L4	i	S1			S2
L	6	500	G 1/8	14,9	20	28	13	21	10,5	8	14	14	14	4,31	FI-RST-06LR-WD-B-W3
	.24	7250		.59	.79	1.10	.51	.83	.41	.31	.55	.55	.55	9.48	
	8	500	G 1/4	18,9	21	29	14	27	13,5	10	19	19	17	8,60	FI-RST-08LR-WD-B-W3
	.31	7250		.74	.83	1.14	.55	1.06	.53	.39	.75	.75	.67	18.92	
	10	500	G 1/4	18,9	22	30	15	27	13,5	10	19	19	19	8,92	FI-RST-10LR-WD-B-W3
	.39	7250		.74	.87	1.18	.59	1.06	.53	.39	.75	.75	.75	19.63	
	12	400	G 3/8	21,9	24,5	32,5	17,5	32,5	16	12	24	22	22	14,78	FI-RST-12LR-WD-B-W3
	.47	5800		.86	.96	1.28	.69	1.28	.63	.47	.94	.87	.87	32.52	
	15	400	G 1/2	26,9	27	35	21	43	19,5	14	30	27	27	27,43	FI-RST-15LR-WD-B-W3
	.59	5800		1.06	1.06	1.38	.83	1.69	.77	.55	1.18	1.06	1.06	60.35	
	18	400	G 1/2	26,9	28	37	20,5	43	21,5	12	30	27	32	1,52	FI-RST-18LR-WD-B-W3
	.71	5800		1.06	1.10	1.46	.81	1.69	.85	.47	1.18	1.06	1.26	3.34	
	22	250	G 3/4	32,9	34,5	43,5	27	48	24	16	36	32	36	45,42	FI-RST-22LR-WD-B-W3
	.87	3625		1.30	1.36	1.71	1.06	1.89	.94	.63	1.42	1.26	1.42	99.91	
	28	250	G 1	39,9	39	48	31,5	59	30,5	18	46	41	41	85,48	FI-RST-28LR-WD-B-W3
	1.10	3625		1.57	1.54	1.89	1.24	2.32	1.20	.71	1.81	1.61	1.61	188.06	
	35	250	G 1 1/4	49,9	46	57	35,5	70	35,5	20	55	50	50	145,79	FI-RST-35LR-WD-B-W3
	1.38	3625		1.96	1.81	2.24	1.40	2.76	1.40	.79	2.17	1.97	1.97	320.75	
42	250	G 1 1/2	55,9	51	63	40	80	40,5	22	65	55	60	217,42	FI-RST-42LR-WD-B-W3	
1.65	3625		2.20	2.01	2.48	1.57	3.15	1.59	.87	2.56	2.17	2.36	478.33		
S	6	500	G 1/4	18,9	23	31	16	27	13,5	10	19	19	17	9,30	FI-RST-06SR-WD-B-W3
	.24	7250		.74	.91	1.22	.63	1.06	.53	.39	.75	.75	.67	20.46	
	8	500	G 1/4	18,9	23	31	16	27	13,5	10	19	19	19	9,97	FI-RST-08SR-WD-B-W3
	.31	7250		.74	.91	1.22	.63	1.06	.53	.39	.75	.75	.75	21.93	
	10	500	G 3/8	21,9	25,5	34,5	18	32,5	16	10	24	22	22	19,08	FI-RST-10SR-WD-B-W3
	.39	7250		.86	1.00	1.36	.71	1.28	.63	.39	.94	.87	.87	41.98	
	12	400	G 3/8	21,9	27	36	18	32,5	16	10	24	22	24	16,36	FI-RST-12SR-WD-B-W3
	.47	5800		.86	1.06	1.42	.71	1.28	.63	.39	.94	.87	.94	35.99	
	14	400	G 1/2	26,9	30	40	22	41	19,5	14	30	27	27	31,86	FI-RST-14SR-WD-B-W3
	.55	5800		1.06	1.18	1.57	.87	1.61	.77	.55	1.18	1.06	1.06	70.09	
	16	400	G 1/2	26,9	30	40	21,5	43	21,5	12	30	27	30	29,20	FI-RST-16SR-WD-B-W3
	.63	5800		1.06	1.18	1.57	.85	1.69	.85	.47	1.18	1.06	1.18	64.24	
	20	315	G 3/4	32,9	36,5	47,5	26	48	24	16	36	32	36	48,66	FI-RST-20SR-WD-B-W3
	.79	4568		1.30	1.44	1.87	1.02	1.89	.94	.63	1.42	1.26	1.42	107.05	
	25	250	G 1	39,9	43	55	31	59	30,5	18	46	41	46	93,55	FI-RST-25SR-WD-B-W3
	.98	3625		1.57	1.69	2.17	1.22	2.32	1.20	.71	1.81	1.61	1.81	205.80	
	30	250	G 1 1/4	49,9	50	63	36,5	70	35,5	20	55	50	50	153,59	FI-RST-30SR-WD-B-W3
	1.18	3625		1.96	1.97	2.48	1.44	2.76	1.40	.79	2.17	1.97	1.97	337.91	
38	250	G 1 1/2	55,9	57	72	41	80	40,5	22	65	55	60	236,22	FI-RST-38SR-WD-B-W3	
1.50	3625		2.20	2.24	2.83	1.61	3.15	1.59	.87	2.56	2.17	2.36	519.69		

¹ Approximate dimension in assembled condition.

Port acc. to DIN 3852-2 (Form X) / ISO 1179-1

² Weight excluding cutting ring and union nut.

³ Standard scope of delivery: Fitting body only.

Standard seal material is NBR (Buna-N®).

Connecting Parts

- Cutting Ring Type **FI-DS** Page 26
- Soft-Sealing Cutting Ring Type **FI-WDDS** Page 27
- Support Sleeve Type **FI-VH** Page 28
- STAUFF Form Ring Type **FI-AR** Page 30
- Union Nut Type **FI-M** Page 31
- 37° Flared Tube Fitting Set Type **FI-AB** Page 35

Spare Parts / Accessories

- Retaining Ring with Captive Seal Type **FI-DIR** Page 213
- O-Ring Type **O-RING** Page 207

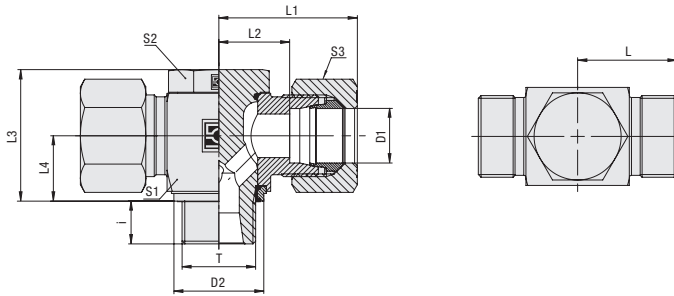

**Banjo Tee (High-Pressure Version)
Type FI-RST-...-M-WD ■ Series L / S**

Retaining Ring with Captive Seal
Metric Parallel Thread

Series	Tube OD (mm/in)	PB (bar/psi)	Dimensions (mm/in)													Weight (kg/lbs) ca. per 100 ²	Ordering Codes ³
			Thread	T	D2	L	L1 ¹	L2	L3	L4	i	S1	S2	S3			
L	6	500	M10x1	13	20	28	13	21	10	8	14	14	14	5,83	FI-RST-06LM-WD-B-W3		
	.24	7250		.51	.79	1.10	.51	.83	.39	.31	.55	.55	.55	12,83			
	8	500	M12x1,5	17,8	21	29	14	27	13,5	10	19	19	17	9,66	FI-RST-08LM-WD-B-W3		
	.31	7250		.70	.83	1.14	.55	1.06	.53	.39	.75	.75	.67	21,25			
	10	500	M14x1,5	17,8	22	30	15	27	13,5	10	19	19	19	13,25	FI-RST-10LM-WD-B-W3		
	.39	7250		.70	.87	1.18	.59	1.06	.53	.39	.75	.75	.75	29,15			
	12	400	M16x1,5	21	24,5	32,5	17,5	32,5	16	10	24	22	22	14,78	FI-RST-12LM-WD-B-W3		
	.47	5800		.83	.96	1.28	.69	1.28	.63	.39	.94	.87	.87	32,52			
	15	400	M18x1,5	23	27	35	20	37	18,5	10	27	24	27	23,90	FI-RST-15LM-WD-B-W3		
	.59	5800		.91	1.06	1.38	.79	1.46	.73	.39	1.06	.94	1.06	52,58			
	18	400	M22x1,5	27	28	37	20,5	43	21,5	12	30	27	32	29,91	FI-RST-18LM-WD-B-W3		
	.71	5800		1.06	1.10	1.46	.81	1.69	.85	.47	1.18	1.06	1.26	65,79			
	22	250	M26x1,5	31	34,5	43,5	27	48	24	16	36	32	36	42,56	FI-RST-22LM-WD-B-W3		
	.87	3625		1.22	1.36	1.71	1.06	1.89	.94	.63	1.42	1.26	1.42	93,64			
	28	250	M33x2	39	39	48	31,5	59	30,5	18	46	41	41	95,43	FI-RST-28LM-WD-B-W3		
	1.10	3625		1.54	1.54	1.89	1.24	2.32	1.20	.71	1.81	1.61	1.61	209,95			
	35	250	M42x2	49	46	57	35,5	70	35,5	20	55	50	50	145,36	FI-RST-35LM-WD-B-W3		
	1.38	3625		1.93	1.81	2.24	1.40	2.76	1.40	.79	2.17	1.97	1.97	319,78			
	42	250	M48x2	55	51	63	40	80	40,5	22	65	55	60	221,72	FI-RST-42LM-WD-B-W3		
	1.65	3625		2.17	2.01	2.48	1.57	3.15	1.59	.87	2.56	2.17	2.36	487,79			
S	6	500	M12x1,5	17,8	23	31	16	27	13,5	10	19	19	17	10,08	FI-RST-06SM-WD-B-W3		
	.24	7250		.70	.91	1.22	.63	1.06	.53	.39	.75	.75	.67	22,17			
	8	500	M14x1,5	17,8	23	31	16	27	13,5	10	19	19	19	10,12	FI-RST-08SM-WD-B-W3		
	.31	7250		.70	.91	1.22	.63	1.06	.53	.39	.75	.75	.75	22,26			
	10	500	M16x1,5	21	25,5	34,5	18	32,5	16	10	24	22	22	14,18	FI-RST-10SM-WD-B-W3		
	.39	7250		.83	1.00	1.36	.71	1.28	.63	.39	.94	.87	.87	31,19			
	12	400	M18x1,5	23	27	36	19,5	37	18,5	10	27	24	24	19,66	FI-RST-12SM-WD-B-W3		
	.47	5800		.91	1.06	1.42	.77	1.46	.73	.39	1.06	.94	.94	43,26			
	14	400	M20x1,5	25	30	40	22	41	19,5	12	30	27	27	29,38	FI-RST-14SM-WD-B-W3		
	.55	5800		.98	1.18	1.57	.87	1.61	.77	.47	1.18	1.06	1.06	64,63			
	16	400	M22x1,5	27	30	40	21,5	43	21,5	12	30	27	30	35,10	FI-RST-16SM-WD-B-W3		
	.63	5800		1.06	1.18	1.57	.85	1.69	.85	.47	1.18	1.06	1.18	77,22			
	20	315	M27x2	32	36,5	47,5	26	48	24	16	36	32	36	45,86	FI-RST-20SM-WD-B-W3		
	.79	4568		1.26	1.44	1.87	1.02	1.89	.94	.63	1.42	1.26	1.42	100,89			
	25	250	M33x2	39	43	55	31	59	30,5	18	46	41	46	82,57	FI-RST-25SM-WD-B-W3		
.98	3625		1.54	1.69	2.17	1.22	2.32	1.20	.71	1.81	1.61	1.81	181,64				
30	250	M42x2	49	50	63	36,5	70	35,5	20	55	50	50	150,16	FI-RST-30SM-WD-B-W3			
1.18	3625		1.93	1.97	2.48	1.44	2.76	1.40	.79	2.17	1.97	1.97	330,36				
38	250	M48x2	55	57	72	41	80	40,5	22	65	55	60	236,35	FI-RST-38SM-WD-B-W3			
1.50	3625		2.17	2.24	2.83	1.61	3.15	1.59	.87	2.56	2.17	2.36	519,97				

¹ Approximate dimension in assembled condition.

Port acc. to DIN 3852-1 (Form X) / ISO 9974-1

² Weight excluding cutting ring and union nut.

³ Standard scope of delivery: Fitting body only.

Standard seal material is NBR (Buna-N®).

Ordering Codes
***FI-RST*-10*L*M*-WD*-B*-W3*-MS**

- * Banjo Tee (High-Pressure Version) **FI-RST**
- * Outside Tube Diameter D1 (in mm) **-10**
- * Series Light Series **L**
Heavy Series **S**
- * Thread Type Metric Parallel Thread **M**
- If required, please indicate special sizes, e.g. M12x1.5!
- * Seal Type Retaining Ring with Captive Seal **-WD**
- * Seal Material NBR (Buna-N®) **-B**
FKM (Viton®) **-V**
EPDM **-E**
- * Material Code Steel, zinc/nickel-plated **-W3**

Please contact STAUFF for alternative materials and surface finishings.

- * Assembling / Kitting Fitting body only **—**
- Fitting body supplied with cutting ring and union nut **-MS**
- Fitting body supplied with soft-sealing cutting ring and union nut **-MSV**

Connecting Parts

- Cutting Ring Type **FI-DS** Page 26
- Soft-Sealing Cutting Ring Type **FI-WDDS** Page 27
- Support Sleeve Type **FI-VH** Page 28
- STAUFF Form Ring Type **FI-AR** Page 30
- Union Nut Type **FI-M** Page 31
- 37° Flared Tube Fitting Set Type **FI-AB** Page 35

Spare Parts / Accessories

- Retaining Ring with Captive Seal Type **FI-DIR** Page 213
- O-Ring Type **O-RING** Page 207





Swivel Elbow

FI-DGWESV

172-173



**Whitworth Parallel Pipe Thread (BSPP) /
Retaining Ring with Captive Seal**
FI-DGWESV-...-R-WD

172



**Metric Parallel Thread /
Retaining Ring with Captive Seal**
FI-DGWESV-...-M-WD

173

L



Swivel Elbow
Type FI-DGWESV-...-R-WD ▪ Series L / S

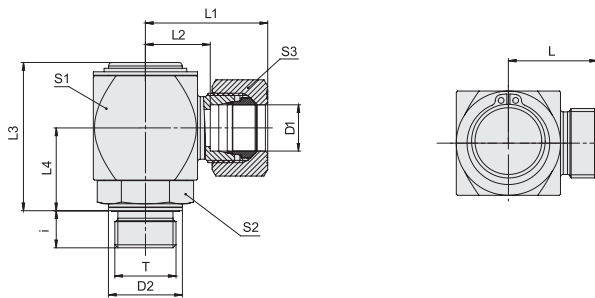

Ordering Codes

***FI-DGWESV*-10*L*R*-WD*-B*-W3*-MS**

- * Swivel Elbow **FI-DGWESV**
- * Outside Tube Diameter D1 (in mm) **-10**
- * Series Light Series **L**
Heavy Series **S**
- * Thread Type Whitworth Parallel Pipe Thread (BSPP) **R**
- If required, please indicate special sizes, e.g. R1/8!
- * Seal Type Profile Sealing Ring **-WD**
- * Seal Material NBR (Buna-N®) **-B**
FKM (Viton®) **-V**
EPDM **-E**
- * Material Code Steel, zinc/nickel-plated **-W3**
- Please contact STAUFF for alternative materials and surface finishings.
- * Assembling / Kitting Fitting body only **—**
Fitting body supplied with cutting ring and union nut **-MS**
Fitting body supplied with soft-sealing cutting ring and union nut **-MSV**

Whitworth Parallel Pipe Thread (BSPP)

Profile Sealing Ring

Series	Tube OD (mm/in)	PN (bar/psi)	Dimensions (mm/in)													Torque (Nm/ft.lb)	Weight (kg/lbs) ca.	Ordering Codes ³
			D1	T	D2	L	L ¹	L2	L3	L4	i	S1	S2	S3	Thread T			
L	6	250	G 1/8	14	23	31	16	40	21	8	27	19	14	18	16,00	FI-DGWESV-06LR-WD-B-W3		
	.24	3625		.55	.91	1.22	.63	1.57	.83	.31	1.06	.75	.55	13.3	35.20			
	6	250	G 1/4	19	23	27	16	41	22	12	27	19	14	40	16,8	FI-DGWESV-06LR1/4-WD-B-W3		
	.24	3625		.75	.91	1.06	.63	1.61	.87	.47	1.06	.75	.55	29.6	36.96			
	8	250	G 1/4	19	25	33	18	46	25	12	30	22	17	40	23,00	FI-DGWESV-08LR-WD-B-W3		
	.31	3625		.75	.98	1.30	.71	1.81	.98	.47	1.18	.87	.67	29.6	50.60			
	10	250	G 1/4	19	26	34	19	46	25	12	30	22	19	40	23,40	FI-DGWESV-10LR-WD-B-W3		
	.39	3625		.75	1.02	1.34	.75	1.81	.98	.47	1.18	.87	.75	29.6	51.48			
	10	250	G 3/8	22	27	35	20	48	27	12	32	24	19	80	27,50	FI-DGWESV-10LR3/8-WD-B-W3		
	.39	3625		.87	1.06	1.38	.79	1.89	1.06	.47	1.26	.94	.75	59.2	60.50			
	12	250	G 3/8	22	27	35	20	48	27	12	32	24	22	80	28,00	FI-DGWESV-12LR-WD-B-W3		
	.47	3625		.87	1.06	1.38	.79	1.89	1.06	.47	1.26	.94	.87	59.2	61.60			
	12	250	G 1/2	27	29	37	22	55	30	14	36	27	22	110	38,80	FI-DGWESV-12LR1/2-WD-B-W3		
	.47	3625		1.06	1.14	1.46	.87	2.17	1.18	.55	1.42	1.06	.87	81.4	85.36			
	15	250	G 1/2	27	32	40	25	59	33	14	40	32	27	110	52,80	FI-DGWESV-15LR-WD-B-W3		
	.59	3625		1.06	1.26	1.57	.98	2.32	1.30	.55	1.57	1.26	1.06	81.4	116.16			
	18	160	G 1/2	27	32	41	24,5	59	33	14	40	32	32	110	52,60	FI-DGWESV-18LR-WD-B-W3		
	.71	2320		1.06	1.26	1.61	.96	2.32	1.30	.55	1.57	1.26	1.26	81.40	115.72			
	22	160	G 3/4	32	36	45	28,5	66	35	16	45	36	36	180	72,00	FI-DGWESV-22LR-WD-B-W3		
	.87	2320		1.26	1.42	1.77	1.12	2.60	1.38	.63	1.77	1.42	1.42	133.2	158.40			
	28	100	G 1	40	41	50	33,5	78	41	18	55	41	41	300	126,70	FI-DGWESV-28LR-WD-B-W3		
	1.10	1450		1.57	1.61	1.97	1.32	3.07	1.61	.71	2.17	1.61	1.61	222.0	278.74			
	35	100	G 1 1/4	50	48	59	37,5	92	51	20	65	50	50	470	208,00	FI-DGWESV-35LR-WD-B-W3		
	1.38	1450		1.97	1.89	2.32	1.48	3.62	2.01	.79	2.56	1.97	1.97	347.8	457.60			
42	100	G 1 1/2	55	53	65	42	102	56	22	75	55	60	540	294,00	FI-DGWESV-42LR-WD-B-W3			
1.65	1450		2.17	2.09	2.56	1.65	4.02	2.20	.87	2.95	2.17	2.36	399.6	646.80				
S	6	400	G 1/4	19	25	33	18	41	22	12	27	19	17	50	17,40	FI-DGWESV-06SR-WD-B-W3		
	.24	5800		.75	.98	1.30	.71	1.61	.87	.47	1.06	.75	.67	37.0	38.28			
	8	400	G 1/4	19	25	33	18	41	22	12	27	19	19	50	18,00	FI-DGWESV-08SR-WD-B-W3		
	.31	5800		.75	.98	1.30	.71	1.61	.87	.47	1.06	.75	.75	37.0	39.60			
	10	400	G 3/8	22	27	36	19,5	46	25	12	30	22	22	80	24,20	FI-DGWESV-10SR-WD-B-W3		
	.39	5800		.87	1.06	1.42	.77	1.81	.98	.47	1.18	.87	.87	59.2	53.24			
	12	400	G 3/8	22	28	37	20,5	48	27	12	32	24	24	80	28,80	FI-DGWESV-12SR-WD-B-W3		
	.47	5800		.87	1.10	1.46	.81	1.89	1.06	.47	1.26	.94	.94	59.2	63.36			
	14	400	G 1/2	27	32	42	24	55	30	14	36	27	30	120	38,00	FI-DGWESV-14SR-WD-B-W3		
	.55	5800		1.06	1.26	1.65	.94	2.17	1.18	.55	1.42	1.06	1.18	88.8	83.60			
	16	400	G 1/2	27	34	44	25,5	59	33	14	40	32	30	120	52,80	FI-DGWESV-16SR-WD-B-W3		
	.63	5800		1.06	1.34	1.73	1.00	2.32	1.30	.55	1.57	1.26	1.18	88.8	116.16			
	20	250	G 3/4	32	38	49	27,5	66	35	16	45	36	36	180	74,00	FI-DGWESV-20SR-WD-B-W3		
	.79	3625		1.26	1.50	1.93	1.08	2.60	1.38	.63	1.77	1.42	1.42	133.2	162.80			
	25	250	G 1	40	45	57	33	78	41	18	55	41	46	300	128,00	FI-DGWESV-25SR-WD-B-W3		
	.98	3625		1.57	1.77	2.24	1.30	3.07	1.61	.71	2.17	1.61	1.81	222.0	281.60			
	30	250	G 1 1/4	50	52	65	38,5	92	51	20	65	50	50	470	214,00	FI-DGWESV-30SR-WD-B-W3		
	1.18	3625		1.97	2.05	2.56	1.52	3.62	2.01	.79	2.56	1.97	1.97	347.8	470.80			
	38	250	G 1 1/2	55	59	74	43	102	56	22	75	55	60	560	298,00	FI-DGWESV-38SR-WD-B-W3		
	1.50	3625		2.17	2.32	2.91	1.69	4.02	2.20	.87	2.95	2.17	2.36	414.4	655.60			

¹ Approximate dimension in assembled condition.

² Weight excluding cutting ring and union nut.

³ Standard scope of delivery: Fitting body only.

Male stud acc. to ISO 1179-2 (Type E)

Port acc. to ISO 1179-1

Torque recommendations for Steel mating material.

Standard seal material is NBR (Buna-N®).

Maximum Number of Revolutions per Minute for Permanent Operation

Dimension S1	(mm)								
	27	30	32	36	40	45	55	65	75
Revolutions Per Minute	6	3	3	1	0,6	0,5	0,4	0,2	0,2

Higher number of revolutions per minute possible when used temporarily / non-permanently.

Recommendations for use with hydraulic oil at a static working pressure not exceeding 200 bar / 2900 PSI.

Connecting Parts

- Cutting Ring Type **FI-DS** Page 26
- Soft-Sealing Cutting Ring Type **FI-WDDS** Page 27
- Support Sleeve Type **FI-VH** Page 28
- STAUFF Form Ring Type **FI-AR** Page 30
- Union Nut Type **FI-M** Page 31
- 37° Flared Tube Fitting Set Type **FI-AB** Page 35

Spare Parts / Accessories

- Profile Sealing Ring Type **WDG** Page 206



Swivel Elbow
Type FI-DGWESV-...-M-WD • Series L / S

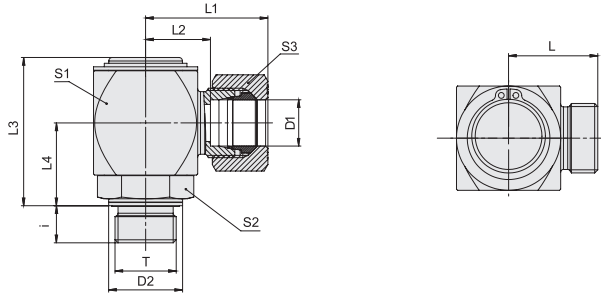

Profile Sealing Ring

Metric Parallel Thread

Series	Tube OD (mm/in)	PN (bar/psi)	Dimensions (mm/in)										Torque (N·m/lb·ft)	Weight (kg/lbs) Ca.	Ordering Codes ³	
			D1	T	D2	L	L ¹	L ²	L ³	L ⁴	i	S1				S2
L	6	250	M 10 x 1	14	23.5	31.5	16.5	40	21	8	27	19	14	18	15.60	FI-DGWESV-06LM-WD-B-W3
	.24	3625		.55	.93	1.24	.65	1.57	.83	.31	1.06	.75	.55	13.32	34.32	
	6	250	M 12 x 1,5	17	23.5	31.5	16.5	41	22	12	27	19	14	25	16.00	FI-DGWESV-06LM12x1,5-WD-B-W3
	.24	3625		.67	.93	1.24	.65	1.61	.87	.47	1.06	.75	.55	18.50	35.20	
	8	250	M 12 x 1,5	17	23.5	31.5	16.5	41	22	12	27	19	17	25	16.80	FI-DGWESV-08LM-WD-B-W3
	.31	3625		.67	.93	1.24	.65	1.61	.87	.47	1.06	.75	.67	18.50	36.96	
	8	250	M 14 x 1,5	19	25	33	18	46	25	12	30	22	17	45	23.30	FI-DGWESV-08LM14x1,5-WD-B-W3
	.31	3625		.75	.98	1.30	.71	1.81	.98	.47	1.18	.87	.67	33.30	51.26	
	10	250	M 14 x 1,5	19	26	34	19	46	25	12	30	22	19	45	23.00	FI-DGWESV-10LM-WD-B-W3
	.39	3625		.75	1.02	1.34	.75	1.81	.98	.47	1.18	.87	.75	33.30	50.60	
	10	250	M 16 x 1,5	22	27	35	20	48	27	12	32	24	19	60	24.80	FI-DGWESV-10LM16x1,5-WD-B-W3
	.39	3625		.87	1.06	1.38	.79	1.89	1.06	.47	1.26	.94	.75	44.40	54.56	
	12	250	M 16 x 1,5	22	27	35	20	48	27	12	32	24	22	60	27.50	FI-DGWESV-12LM-WD-B-W3
	.47	3625		.87	1.06	1.38	.79	1.89	1.06	.47	1.26	.94	.87	44.40	60.50	
	12	250	M 18 x 1,5	24	29	37	22	55	30	12	36	27	22	100	39.20	FI-DGWESV-12LM18x1,5-WD-B-W3
	.47	3625		.94	1.14	1.46	.87	2.17	1.18	.47	1.42	1.06	.87	74.00	86.24	
	15	250	M 18 x 1,5	24	30	38	23	55	30	12	36	27	27	100	39.00	FI-DGWESV-15LM-WD-B-W3
	.59	3625		.94	1.18	1.50	.91	2.17	1.18	.47	1.42	1.06	1.06	74.00	85.80	
	15	250	M 22 x 1,5	27	32	40	25	59	33	14	40	32	27	125	52.50	FI-DGWESV-15LM22x1,5-WD-B-W3
	.59	3625		1.06	1.26	1.57	.98	2.32	1.30	.55	1.57	1.26	1.06	92.50	115.50	
	18	160	M 22 x 1,5	27	32	41	24,5	59	33	14	40	32	32	125	53,50	FI-DGWESV-18LM-WD-B-W3
	.71	2320		1.06	1.26	1.61	.96	2.32	1.30	.55	1.57	1.26	1.26	92.50	117,70	
	22	160	M 26 x 1,5	32	36,5	45,5	29	66	35	16	45	36	36	180	70,00	FI-DGWESV-22LM-WD-B-W3
	.87	2320		1.26	1.44	1.79	1.14	2.60	1.38	.63	1.77	1.42	1.42	133,20	154,00	
28	100	M 33 x 2	40	41,5	51	34	78	41	18	55	41	41	300	128,00	FI-DGWESV-28LM-WD-B-W3	
1.10	1450		1.57	1.63	2.01	1.34	3.07	1.61	.71	2.17	1.61	1.61	222,00	281,60		
35	100	M 42 x 2	50	48,5	59,5	38	92	50	20	65	50	50	450	206,00	FI-DGWESV-35LM-WD-B-W3	
1.38	1450		1.97	1.91	2.34	1.50	3.62	1.97	.79	2.56	1.97	1.97	333,00	453,20		
42	100	M 48 x 2	55	53,5	65,5	42,5	102	56	22	75	55	60	540	294,00	FI-DGWESV-42LM-WD-B-W3	
1.65	1450		2.17	2.11	2.58	1.67	4.02	2.20	.87	2.95	2.17	2.36	399,60	646,80		
S	6	400	M 12 x 1,5	17	25,5	33,5	18,5	41	22	12	27	19	17	35	17,20	FI-DGWESV-06SM-WD-B-W3
	.24	5800		.67	1.00	1.32	.73	1.61	.87	.47	1.06	.75	.67	25.90	37.84	
	8	400	M 14 x 1,5	19	25,5	33,5	18,5	41	22	12	27	19	19	55	18,20	FI-DGWESV-08SM-WD-B-W3
	.31	5800		.75	1.00	1.32	.73	1.61	.87	.47	1.06	.75	.75	40.70	40.04	
	10	400	M 16 x 1,5	22	27	36	19,5	46	25	12	30	22	22	70	23,80	FI-DGWESV-10SM-WD-B-W3
	.39	5800		.87	1.06	1.42	.77	1.81	.98	.47	1.18	.87	.87	51.80	52.36	
	12	400	M 18 x 1,5	24	28	37	20,5	48	27	12	32	24	24	90	28,20	FI-DGWESV-12SM-WD-B-W3
	.47	5800		.94	1.10	1.46	.81	1.89	1.06	.47	1.26	.94	.94	66.60	62.04	
	14	400	M 20 x 1,5	26	32	42	24	55	30	14	36	27	30	125	45,00	FI-DGWESV-14SM-WD-B-W3
	.55	5800		1.02	1.26	1.65	.94	2.17	1.18	.55	1.42	1.06	1.18	92.50	99.00	
	16	400	M 22 x 1,5	27	34	44	25,5	59	33	14	40	32	30	135	53,60	FI-DGWESV-16SM-WD-B-W3
	.63	5800		1.06	1.34	1.73	1.00	2.32	1.30	.55	1.57	1.26	1.18	99.90	117,92	
	20	250	M 27 x 2	32	38,5	49,5	28	66	35	16	45	36	36	180	71,50	FI-DGWESV-20SM-WD-B-W3
	.79	3625		1.26	1.52	1.95	1.10	2.60	1.38	.63	1.77	1.42	1.42	133,20	157,30	
	25	250	M 33 x 2	40	45,5	57,5	33,5	78	41	18	55	41	46	310	128,20	FI-DGWESV-25SM-WD-B-W3
	.98	3625		1.57	1.79	2.26	1.32	3.07	1.61	.71	2.17	1.61	1.81	229,40	282,04	
	30	250	M 42 x 2	50	52,5	65,5	39	92	51	20	65	50	50	470	210,00	FI-DGWESV-30SM-WD-B-W3
	1.18	3625		1.97	2.07	2.58	1.54	3.62	2.01	.79	2.56	1.97	1.97	347,80	462,00	
38	250	M 48 x 2	55	59,5	74,5	43,5	102	56	22	75	55	60	800	300,00	FI-DGWESV-38SM-WD-B-W3	
1.50	3625		2.17	2.34	2.93	1.71	4.02	2.20	.87	2.95	2.17	2.36	592,00	660,00		

Ordering Codes

FI-DGWESV-10*L*M*-WD*-B*-W3*-MS

* Swivel Elbow FI-DGWESV

* Outside Tube Diameter D1 (in mm) -10

* Series Light Series L
Heavy Series S

* Thread Type Metric Parallel Thread M

If required, please indicate special sizes, e.g. M27x2!

* Seal Type Profile Sealing Ring -WD

* Seal Material NBR (Buna-N®) -B
FKM (Viton®) -V
EPDM -E

* Material Code Steel, zinc/nickel-plated -W3

Please contact STAUFF for alternative materials and surface finishings.

* Assembling / Kitting Fitting body only —

Fitting body supplied with cutting ring and union nut -MS

Fitting body supplied with soft-sealing cutting ring and union nut -MSV

Connecting Parts

	Cutting Ring Type FI-DS	Page 26
	Soft-Sealing Cutting Ring Type FI-WDDS	Page 27
	Support Sleeve Type FI-VH	Page 28
	STAUFF Form Ring Type FI-AR	Page 30
	Union Nut Type FI-M	Page 31
	37° Flared Tube Fitting Set Type FI-AB	Page 35

Spare Parts / Accessories

	Profile Sealing Ring Type WDG	Page 206
--	----------------------------------	----------

¹ Approximate dimension in assembled condition.

² Weight excluding cutting ring and union nut.

³ Standard scope of delivery: Fitting body only.

Male stud acc. to ISO 9974-2 (Type E)

Port acc. to ISO 9974-1

Torque recommendations for Steel mating material.

Standard seal material is NBR (Buna-N®).









Maximum Number of Revolutions per Minute for Permanent Operation

Dimension S1	(mm)	27	30	32	36	40	45	55	65	75
	(in)	1.06	1.18	1.26	1.42	1.57	1.77	2.17	2.56	2.95
Revolutions Per Minute		6	3	3	1	0,6	0,5	0,4	0,2	0,2

Higher number of revolutions per minute possible when used temporarily / non-permanently. Recommendations for use with hydraulic oil at a static working pressure not exceeding 200 bar / 2900 PSI.





	Check Valve FI-RV	176
	Male Stud Check Valve (Flow from Stud End) FI-RVV	178-179
	Whitworth Parallel Pipe Thread (BSPP) / Profile Sealing Ring FI-RVV-...-R-WD	178
	Metric Parallel Thread / Profile Sealing Ring FI-RVV-...-M-WD	179
	Male Stud Check Valve (Flow to Stud End) FI-RVZ	180-181
	Whitworth Parallel Pipe Thread (BSPP) / Profile Sealing Ring FI-RVZ-...-R-WD	180
	Metric Parallel Thread / Profile Sealing Ring FI-RVZ-...-M-WD	181
	Female Stud Check Valve FI-RVI	182
	Female Whitworth Parallel Pipe Thread (BSPP) FI-RVI-...-R	182
	Check Valve Installation Kit FI-VES	183
	Alternating Valve FI-WV	184

Check Valve
Type FI-RV • Series L / S

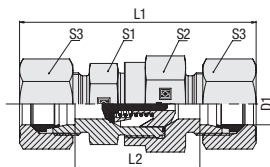

Standard Opening Pressure: 1 bar / 14.5 PSI

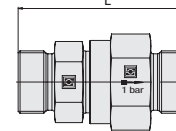

Ordering Codes

***FI-RV*-10*L*-W3*-1*-MS**

- * Check Valve **FI-RV**
- * Outside Tube Diameter D1 (in mm) **-10**
- * Series **L**
Light Series
Heavy Series **S**
- * Material Code **-W3**
Steel, zinc/nickel-plated
- Please contact STAUFF for alternative materials and surface finishings.
- * Opening Pressure **1**
1 bar / 14.5 PSI
Contact STAUFF for alternative opening pressures.
- * Assembling / Kitting **—**
Valve body only
- MS**
Valve body supplied with cutting rings and union nuts
- MSV**
Valve body supplied with soft-sealing cutting rings and union nuts

Connecting Parts

- Cutting Ring
Type **FI-DS** Page 26
- Soft-Sealing Cutting Ring
Type **FI-WDDS** Page 27
- Support Sleeve
Type **FI-VH** Page 28
- STAUFF Form Ring
Type **FI-AR** Page 30
- Union Nut
Type **FI-M** Page 31
- 37° Flared Tube Fitting Set
Type **FI-AB** Page 35

Series	Tube OD PN		Dimensions						Weight (kg/lbs) ca. per 100 ²	Ordering Codes ³
	(mm/in)	(bar/PSI)	(mm/in)							
	D1	L	L1 ¹	L2	S1	S2	S3			
L	6	400	52	67	38	22	27	14	11,93	FI-RV-06L-W3-1
	.24	5800	2,05	2,64	1,50	.87	1,06	.55	26,24	
	8	400	52	67	38	22	27	17	12,41	FI-RV-08L-W3-1
	.31	5800	2,05	2,64	1,50	.87	1,06	.67	27,30	
	10	400	52	67	38	22	27	19	11,65	FI-RV-10L-W3-1
	.39	5800	2,05	2,64	1,50	.87	1,06	.75	25,64	
	12	400	53	68	39	22	27	22	12,31	FI-RV-12L-W3-1
	.47	5800	2,09	2,68	1,54	.87	1,06	.87	27,07	
	15	400	58	74	44	27	32	27	18,29	FI-RV-15L-W3-1
	.59	5800	2,28	2,91	1,73	1,06	1,26	1,06	40,25	
	18	400	63	80	48	27	32	32	22,54	FI-RV-18L-W3-1
	.71	5800	2,48	3,15	1,89	1,06	1,26	1,26	49,59	
	22	250	75	92	60	41	46	36	48,21	FI-RV-22L-W3-1
	.87	3625	2,95	3,62	2,36	1,61	1,81	1,42	106,05	
	28	250	81	99	66	41	46	41	57,90	FI-RV-28L-W3-1
	1.10	3625	3,19	3,90	2,60	1,61	1,81	1,61	127,38	
	35	250	92	114	71	60	70	50	129,80	FI-RV-35L-W3-1
	1.38	3625	3,62	4,49	2,80	2,36	2,76	1,97	285,56	
	42	250	87	111	65	60	70	60	122,60	FI-RV-42L-W3-1
	1.65	3625	3,43	4,37	2,56	2,36	2,76	2,36	269,72	
S	6	400	56	71	42	22	27	17	13,12	FI-RV-06S-W3-1
	.24	5800	2,20	2,80	1,65	.87	1,06	.67	28,87	
	8	400	52	67	38	22	27	19	11,98	FI-RV-08S-W3-1
	.31	5800	2,05	2,64	1,50	.87	1,06	.75	26,35	
	10	400	54	71	39	22	27	22	13,20	FI-RV-10S-W3-1
	.39	5800	2,13	2,80	1,54	.87	1,06	.87	29,04	
	12	400	55	72	40	22	27	24	13,61	FI-RV-12S-W3-1
	.47	5800	2,17	2,83	1,57	.87	1,06	.94	29,94	
	14	400	62	81	46	27	32	27	19,98	FI-RV-14S-W3-1
	.55	5800	2,44	3,19	1,81	1,06	1,26	1,06	43,96	
	16	400	65	84	48	27	32	30	21,56	FI-RV-16S-W3-1
	.63	5800	2,56	3,31	1,89	1,06	1,26	1,18	47,44	
	20	400	78	100	57	41	46	36	50,20	FI-RV-20S-W3-1
	.79	5800	3,07	3,94	2,24	1,61	1,81	1,42	110,45	
	25	250	81	105	57	41	46	46	52,60	FI-RV-25S-W3-1
	.98	3625	3,19	4,13	2,24	1,61	1,81	1,81	115,72	
	30	250	91	117	64	50	55	50	80,70	FI-RV-30S-W3-1
	1.18	3625	3,58	4,61	2,52	1,97	2,17	1,97	177,54	
38	250	99	129	67	60	70	60	136,00	FI-RV-38S-W3-1	
1.50	3625	3,90	5,08	2,64	2,36	2,76	2,36	299,20		

¹ Approximate dimension in assembled condition.

² Weight excluding cutting rings and union nuts.

³ Standard scope of delivery: Valve body only.

Please note: Internal seals are made of FKM (Viton®).

In order to make sure that the valves will be suitable for your particular application, please contact STAUFF with details on media, operating pressure, pressure peaks, operating temperature and the expected frequency of valve actuations.



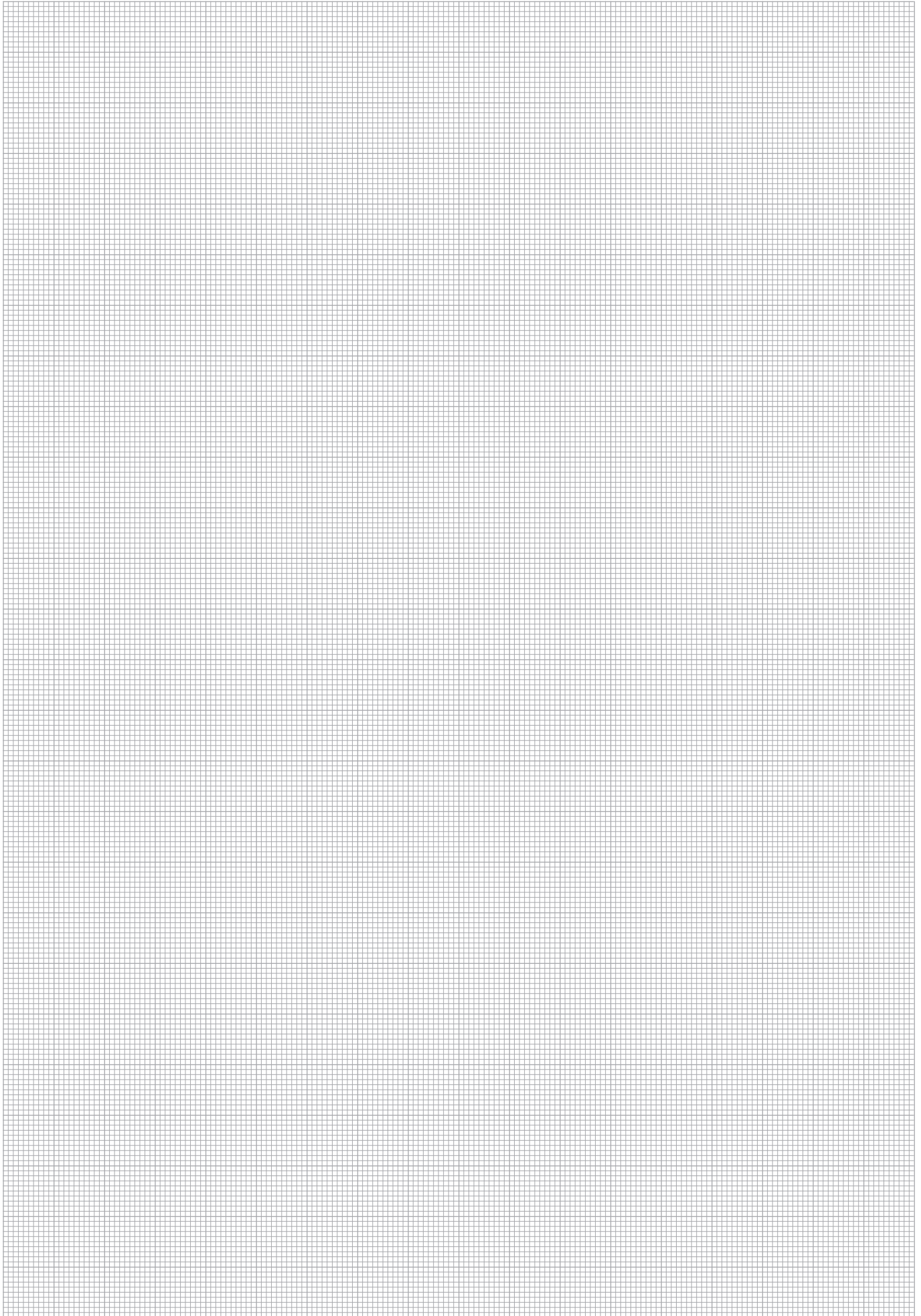

M



Male Stud Check Valve Type FI-RVV...-R-WD ■ Series L / S

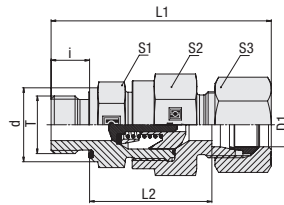

Flow Direction: A > B (from Stud End)
Standard Opening Pressure: 1 bar / 14.5 PSI

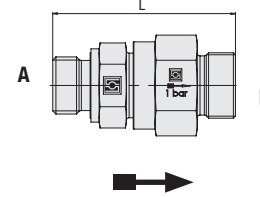

Ordering Codes

- *FI-RVV*-10*L*R*-WD*-B*-W3*-1*-MS**
- * Male Stud Check Valve (Flow from Stud End) FI-RVV**
- * Outside Tube Diameter D1 (in mm) -10**
- * Series Light Series L Heavy Series S**
- * Thread Type Whitworth Parallel Pipe Thread (BSPP) R**
- If required, please indicate special sizes, e.g. R1/8!
- * Seal Type Profile Sealing Ring -WD**
- * Seal Material NBR (Buna-N®) -B FKM (Viton®) -V EPDM -E**
- * Material Code Steel, zinc/nickel-plated -W3**
- Please contact STAUFF for alternative materials and surface finishings.
- * Opening Pressure 1 bar / 14.5 PSI 1**
- Contact STAUFF for alternative opening pressures.
- * Assembling / Kitting Valve body only —**
- Valve body supplied with cutting ring and union nut **-MS**
- Valve body supplied with soft-sealing cutting ring and union nut **-MSV**

Whitworth Parallel Pipe Thread (BSPP)

Profile Sealing Ring

Series	Tube OD (mm/in)	PN (bar/PSI)	Dimensions (mm/in)										Torque (N·m/ft·lb)	Weight (kg/lbs) ca.	Ordering Codes ³
			Thread	T	d	L	L1 ¹	L2	i	S1	S2	S3			
L	6	400	G 1/8	13,9	51	59	36	8	22	27	14	18	11,69	FI-RVV-06LR-WD-B-W3-1	
	.24	5800	G 1/8	.55	2.01	2.32	1.42	.31	.87	1.06	.55	13.3	25.71	FI-RVV-08LR-WD-B-W3-1	
	8	400	G 1/4	18,9	55	63	36	12	22	27	17	30	12,54	FI-RVV-10LR-WD-B-W3-1	
	.31	5800	G 1/4	.74	2.17	2.48	1.42	.47	.87	1.06	.67	22.2	27.58	FI-RVV-12LR-WD-B-W3-1	
	10	400	G 1/4	18,9	53	61	34	12	22	27	19	45	11,40	FI-RVV-15LR-WD-B-W3-1	
	.39	5800	G 1/4	.74	2.09	2.40	1.34	.47	.87	1.06	.75	33.3	25.08	FI-RVV-18LR-WD-B-W3-1	
	12	400	G 3/8	21,9	58	66	39	12	22	27	22	70	13,62	FI-RVV-22LR-WD-B-W3-1	
	.47	5800	G 3/8	.86	2.28	2.60	1.54	.47	.87	1.06	.87	51.8	29.97	FI-RVV-28LR-WD-B-W3-1	
	15	400	G 1/2	26,9	60	68	41	14	27	32	27	90	19,68	FI-RVV-35LR-WD-B-W3-1	
	.59	5800	G 1/2	1.06	2.36	2.68	1.61	.55	1.06	1.26	1.06	66.6	43.30	FI-RVV-42LR-WD-B-W3-1	
	18	400	G 1/2	26,9	67	76	45,5	14	27	32	32	90	22,68	FI-RVV-48LR-WD-B-W3-1	
	.71	5800	G 1/2	1.06	2.64	2.99	1.79	.55	1.06	1.26	1.26	66.6	49.89	FI-RVV-54LR-WD-B-W3-1	
	22	250	G 3/4	31,9	77	86	53,5	16	41	46	36	180	46,49	FI-RVV-60LR-WD-B-W3-1	
	.87	3625	G 3/4	1.26	3.03	3.39	2.11	.63	1.61	1.81	1.42	133.2	102.28	FI-RVV-66LR-WD-B-W3-1	
	28	250	G 1	39,9	86	95	60,5	18	41	46	41	310	59,70	FI-RVV-72LR-WD-B-W3-1	
	1.10	3625	G 1	1.57	3.39	3.74	2.38	.71	1.61	1.81	1.61	229.4	131.34	FI-RVV-78LR-WD-B-W3-1	
	35	250	G 1 1/4	49,9	97,5	108,5	67	20	60	70	50	450	132,20	FI-RVV-84LR-WD-B-W3-1	
	1.38	3625	G 1 1/4	1.96	3.84	4.27	2.64	.79	2.36	2.76	1.97	333.0	290.84	FI-RVV-90LR-WD-B-W3-1	
	42	250	G 1 1/2	54,9	97,5	109,5	64,5	22	60	70	60	540	137,40	FI-RVV-96LR-WD-B-W3-1	
	1.65	3625	G 1 1/2	2.16	3.84	4.31	2.54	.87	2.36	2.76	2.36	399.6	302.28	FI-RVV-102LR-WD-B-W3-1	
S	6	400	G 1/4	18,9	57	65	38	12	22	27	17	55	12,95	FI-RVV-06SR-WD-B-W3-1	
	.24	5800	G 1/4	.74	2.24	2.56	1.50	.47	.87	1.06	.67	40.7	28.49	FI-RVV-08SR-WD-B-W3-1	
	8	400	G 1/4	18,9	55	63	36	12	22	27	19	55	12,12	FI-RVV-10SR-WD-B-W3-1	
	.31	5800	G 1/4	.74	2.17	2.48	1.42	.47	.87	1.06	.75	40.7	26.66	FI-RVV-12SR-WD-B-W3-1	
	10	400	G 3/8	21,9	57	66	37,5	12	22	27	22	80	13,32	FI-RVV-14SR-WD-B-W3-1	
	.39	5800	G 3/8	.86	2.24	2.60	1.48	.47	.87	1.06	.87	59.2	29.30	FI-RVV-16SR-WD-B-W3-1	
	12	400	G 3/8	21,9	59	68	39,5	12	22	27	24	80	14,64	FI-RVV-18SR-WD-B-W3-1	
	.47	5800	G 3/8	.86	2.32	2.68	1.56	.47	.87	1.06	.94	59.2	32.21	FI-RVV-20SR-WD-B-W3-1	
	14	400	G 1/2	26,9	64	74	42	14	27	32	27	115	20,26	FI-RVV-22SR-WD-B-W3-1	
	.55	5800	G 1/2	1.06	2.52	2.91	1.65	.55	1.06	1.26	1.06	85.1	44.57	FI-RVV-24SR-WD-B-W3-1	
	16	400	G 1/2	26,9	67	77	44,5	14	27	32	30	115	21,59	FI-RVV-26SR-WD-B-W3-1	
	.63	5800	G 1/2	1.06	2.64	3.03	1.75	.55	1.06	1.26	1.18	85.1	47.50	FI-RVV-28SR-WD-B-W3-1	
	20	400	G 3/4	31,9	79	90	52,5	16	41	46	36	180	50,90	FI-RVV-30SR-WD-B-W3-1	
	.79	5800	G 3/4	1.26	3.11	3.54	2.07	.63	1.61	1.81	1.42	133.2	111.98	FI-RVV-32SR-WD-B-W3-1	
	25	250	G 1	39,9	83	95	53	18	41	46	46	310	53,10	FI-RVV-34SR-WD-B-W3-1	
	.98	3625	G 1	1.57	3.27	3.74	2.09	.71	1.61	1.81	1.81	229.4	116.82	FI-RVV-36SR-WD-B-W3-1	
	30	250	G 1 1/4	49,9	94	107	60,5	20	50	55	50	450	86,00	FI-RVV-38SR-WD-B-W3-1	
	1.18	3625	G 1 1/4	1.96	3.70	4.21	2.38	.79	1.97	2.17	1.97	333.0	189.20	FI-RVV-40SR-WD-B-W3-1	
38	250	G 1 1/2	54,9	103,5	118,5	65,5	22	60	70	60	540	143,70	FI-RVV-42SR-WD-B-W3-1		
1.50	3625	G 1 1/2	2.16	4.07	4.67	2.58	.87	2.36	2.76	2.36	399.6	316.14	FI-RVV-44SR-WD-B-W3-1		

¹ Approximate dimension in assembled condition.
² Weight excluding cutting ring and union nut.
³ Standard scope of delivery: Valve body only.

Male stud acc. to ISO 1179-2 (Type E)
Port acc. to ISO 1179-1

Torque recommendations for Steel mating material.

Standard seal material is NBR (Buna-N®).
Please note: Internal seals are made of FKM (Viton®).

In order to make sure that the valves will be suitable for your particular application, please contact STAUFF with details on media, operating pressure, pressure peaks, operating temperature and the expected frequency of valve actuations.

M

Connecting Parts

- Cutting Ring
Type **FI-DS** Page 26
- Soft-Sealing Cutting Ring
Type **FI-WDDS** Page 27
- Support Sleeve
Type **FI-VH** Page 28
- STAUFF Form Ring
Type **FI-AR** Page 30
- Union Nut
Type **FI-M** Page 31
- 37° Flared Tube Fitting Set
Type **FI-AB** Page 35

Spare Parts / Accessories

- Profile Sealing Ring
Type **WDG** Page 206



Male Stud Check Valve Type FI-RVV-...-M-WD • Series L / S

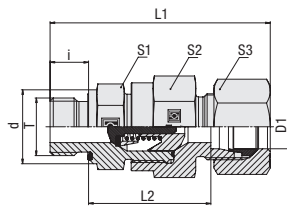

Flow Direction: A > B (from Stud End)
Standard Opening Pressure: 1 bar / 14.5 PSI

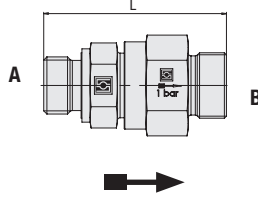

Profile Sealing Ring

Metric Parallel Thread

Series	Tube OD (mm/in)	PN (bar/PSI)	Dimensions (mm/in)										Torque (N-m/ft-lb)	Weight (kg/lbs) ca.	Ordering Codes ³
			Thread	T	d	L	L ¹	L ²	i	S1	S2	S3			
L	6	400	M 10 x 1	13,9	51	59	36	8	22	27	14	18	10,58	FI-RVV-06LM-WD-B-W3-1	
	.24	5800		.55	2.01	2.32	1.42	.31	.87	1.06	.55	13.3	23.27		
	8	400	M 12 x 1,5	16,9	55	63	36	12	22	27	17	25	12,28	FI-RVV-08LM-WD-B-W3-1	
	.31	5800		.67	2.17	2.48	1.42	.47	.87	1.06	.67	18.5	27.02		
	10	400	M 14 x 1,5	18,9	53	61	34	12	22	27	19	45	11,39	FI-RVV-10LM-WD-B-W3-1	
	.39	5800		.74	2.09	2.40	1.34	.47	.87	1.06	.75	33.3	25.06		
	12	400	M 16 x 1,5	21,9	58	66	39	12	22	27	22	55	13,50	FI-RVV-12LM-WD-B-W3-1	
	.47	5800		.86	2.28	2.60	1.54	.47	.87	1.06	.87	40.7	29.69		
	15	400	M 18 x 1,5	23,9	60	68	41	12	27	32	27	70	18,42	FI-RVV-15LM-WD-B-W3-1	
	.59	5800		.94	2.36	2.68	1.61	.47	1.06	1.26	1.06	51.8	40.52		
	18	400	M 22 x 1,5	26,9	67	76	45,5	14	27	32	32	125	23,09	FI-RVV-18LM-WD-B-W3-1	
	.71	5800		1.06	2.64	2.99	1.79	.55	1.06	1.26	1.26	92.5	50.80		
	22	250	M 26 x 1,5	31,9	77	86	53,5	16	41	46	36	180	46,70	FI-RVV-22LM-WD-B-W3-1	
	.87	3625		1.26	3.03	3.39	2.11	.63	1.61	1.81	1.42	133.2	102.74		
	28	250	M 33 x 2	39,9	86	95	60,5	18	41	46	41	310	59,70	FI-RVV-28LM-WD-B-W3-1	
	1.10	3625		1.57	3.39	3.74	2.38	.71	1.61	1.81	1.61	229.4	131.34		
	35	250	M 42 x 2	49,9	97,5	108,5	67	20	60	70	50	450	132,20	FI-RVV-35LM-WD-B-W3-1	
	1.38	3625		1.96	3.84	4.27	2.64	.79	2.36	2.76	1.97	333.0	290.84		
	42	250	M 48 x 2	54,9	97,5	109,5	64,5	22	60	70	60	540	137,20	FI-RVV-42LM-WD-B-W3-1	
	1.65	3625		2.16	3.84	4.31	2.54	.87	2.36	2.76	2.36	399.6	301.84		
S	6	400	M 12 x 1,5	16,9	57	65	38	12	22	27	17	35	11,23	FI-RVV-06SM-WD-B-W3-1	
	.24	5800		.67	2.24	2.56	1.50	.47	.87	1.06	.67	25.9	24.70		
	8	400	M 14 x 1,5	18,9	55	63	36	12	22	27	19	55	11,55	FI-RVV-08SM-WD-B-W3-1	
	.31	5800		.74	2.17	2.48	1.42	.47	.87	1.06	.75	40.7	25.42		
	10	400	M 16 x 1,5	21,9	57	66	37,5	12	22	27	22	70	13,29	FI-RVV-10SM-WD-B-W3-1	
	.39	5800		.86	2.24	2.60	1.48	.47	.87	1.06	.87	51.8	29.23		
	12	400	M 18 x 1,5	23,9	59	68	39,5	12	24	27	24	90	15,56	FI-RVV-12SM-WD-B-W3-1	
	.47	5800		.94	2.32	2.68	1.56	.47	.94	1.06	.94	66.6	34.22		
	14	400	M 20 x 1,5	25,9	64	74	42	14	27	32	27	125	19,94	FI-RVV-14SM-WD-B-W3-1	
	.55	5800		1.02	2.52	2.91	1.65	.55	1.06	1.26	1.06	92.5	43.87		
	16	400	M 22 x 1,5	26,9	67	77	44,5	14	27	32	30	135	21,40	FI-RVV-16SM-WD-B-W3-1	
	.63	5800		1.06	2.64	3.03	1.75	.55	1.06	1.26	1.18	99.9	47.08		
	20	400	M 27 x 2	31,9	79	90	52,5	16	41	46	36	180	50,99	FI-RVV-20SM-WD-B-W3-1	
	.79	5800		1.26	3.11	3.54	2.07	.63	1.61	1.81	1.42	133.2	112.18		
	25	250	M 33 x 2	39,9	83	95	53	18	41	46	46	310	53,50	FI-RVV-25SM-WD-B-W3-1	
	.98	3625		1.57	3.27	3.74	2.09	.71	1.61	1.81	1.81	229.4	117.70		
30	250	M 42 x 2	49,9	94	107	60,5	20	50	55	50	450	86,80	FI-RVV-30SM-WD-B-W3-1		
1.18	3625		1.96	3.70	4.21	2.38	.79	1.97	2.17	1.97	333.0	190.96			
38	250	M 48 x 2	54,9	104	119	66	22	60	70	60	540	144,70	FI-RVV-38SM-WD-B-W3-1		
1.50	3625		2.16	4.09	4.69	2.60	.87	2.36	2.76	2.36	399.6	318.34			

¹ Approximate dimension in assembled condition.

² Weight excluding cutting ring and union nut.

³ Standard scope of delivery: Valve body only.

Standard seal material is NBR (Buna-N®).

Please note: Internal seals are made of FKM (Viton®).

In order to make sure that the valves will be suitable for your particular application, please contact STAUFF with details on media, operating pressure, pressure peaks, operating temperature and the expected frequency of valve actuations.

Male stud acc. to ISO 9974-2 (Type E)

Port acc. to ISO 9974-1

Torque recommendations for Steel mating material.

Ordering Codes

***FI-RVV*-10*L*M*-WD*-B*-W3*-1*-MS**

* Male Stud Check Valve (Flow from Stud End) **FI-RVV**

* Outside Tube Diameter D1 (in mm) **-10**

* Series **L**
Light Series
S
Heavy Series

* Thread Type **M**
Metric Parallel Thread

If required, please indicate special sizes, e.g. M12x1.5!

* Seal Type **-WD**
Profile Sealing Ring

* Seal Material **-B**
NBR (Buna-N®)
-V
FKM (Viton®)
-E
EPDM

* Material Code **-W3**
Steel, zinc/nickel-plated

Please contact STAUFF for alternative materials and surface finishings.

* Opening Pressure **1**
1 bar / 14.5 PSI

Contact STAUFF for alternative opening pressures.

* Assembling / Kitting **—**
Fitting body only

-MS
Valve body supplied with cutting ring and union nut

-MSV
Valve body supplied with soft-sealing cutting ring and union nut

Connecting Parts

Cutting Ring
Type **FI-DS** Page 26

Soft-Sealing Cutting Ring
Type **FI-WDDS** Page 27

Support Sleeve
Type **FI-VH** Page 28

STAUFF Form Ring
Type **FI-AR** Page 30

Union Nut
Type **FI-M** Page 31

37° Flared Tube Fitting Set
Type **FI-AB** Page 35

Spare Parts / Accessories

Profile Sealing Ring
Type **WDG** Page 206



Male Stud Check Valve
Type FI-RVZ-...-R-WD • Series L / S

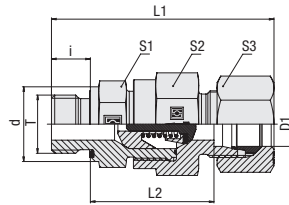

Flow Direction: B > A (to Stud End)
Standard Opening Pressure: 1 bar / 14.5 PSI

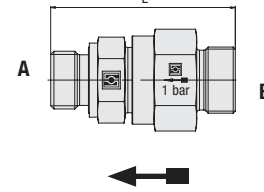

Whitworth Parallel Pipe Thread (BSPP)

Profile Sealing Ring

Ordering Codes

***FI-RVZ*-10*L*R*-WD*-B*-W3*-1*-MS**

- * Male Stud Check Valve (Flow to Stud End) **FI-RVZ**
- * Outside Tube Diameter D1 (in mm) **-10**
- * Series Light Series **L**
Heavy Series **S**
- * Thread Type Whitworth Parallel Pipe Thread (BSPP) **R**
- If required, please indicate special sizes, e.g. R1/8!
- * Seal Type Profile Sealing Ring **-WD**
- * Seal Material NBR (Buna-N®) **-B**
FKM (Viton®) **-V**
EPDM **-E**
- * Material Code Steel, zinc/nickel-plated **-W3**
- Please contact STAUFF for alternative materials and surface finishings.
- * Opening Pressure 1 bar / 14.5 PSI **1**
- Contact STAUFF for alternative opening pressures.
- * Assembling / Kitting Valve body only **—**
Valve body supplied with cutting ring and union nut **-MS**
Valve body supplied with soft-sealing cutting ring and union nut **-MSV**

Series	Tube OD (mm/in)	PN (bar/PSI)	Dimensions (mm/in)										Torque (N·m/ft·lb)	Weight (kg/lbs) ca.	Ordering Codes ³
			Thread	T	d	L	L1 ¹	L2	i	S1	S2	S3			
L	6	400	G 1/8	13,9	51	59	36	8	22	27	14	18	12,07	FI-RVZ-06LR-WD-B-W3-1	
	.24	5800		.55	2.01	2.32	1.42	.31	.87	1.06	.55	13.3	26.55		
	8	400		G 1/4	18,9	55	63	36	12	22	27	17	30		12,56
	.31	5800	.74		2.17	2.48	1.42	.47	.87	1.06	.67	22.2	27.63		
	10	400	G 1/4	18,9	53	61	34	12	22	27	19	45	11,38	FI-RVZ-10LR-WD-B-W3-1	
	.39	5800		.74	2.09	2.40	1.34	.47	.87	1.06	.75	33.3	25.04		
	12	400	G 3/8	21,9	58	66	39	12	22	27	22	70	13,64	FI-RVZ-12LR-WD-B-W3-1	
	.47	5800		.86	2.28	2.60	1.54	.47	.87	1.06	.87	51.8	30.00		
	15	400	G 1/2	26,9	62	70	41	14	27	32	27	90	19,15	FI-RVZ-15LR-WD-B-W3-1	
	.59	5800		1.06	2.44	2.76	1.61	.55	1.06	1.26	1.06	66.6	42.12		
	18	400	G 1/2	26,9	67	76	45,5	14	27	32	32	90	22,67	FI-RVZ-18LR-WD-B-W3-1	
	.71	5800		1.06	2.64	2.99	1.79	.55	1.06	1.26	1.26	66.6	49.88		
	22	250	G 3/4	31,9	77	86	53,5	16	46	41	36	180	45,69	FI-RVZ-22LR-WD-B-W3-1	
	.87	3625		1.26	3.03	3.39	2.11	.63	1.81	1.61	1.42	133.2	100.53		
	28	250	G 1	39,9	80	89	54,5	18	46	41	41	310	52,60	FI-RVZ-28LR-WD-B-W3-1	
	1.10	3625		1.57	3.15	3.50	2.15	.71	1.81	1.61	1.61	229.4	115.72		
	35	250	G 1 1/4	49,9	97,5	108,5	67	20	60	70	50	450	130,70	FI-RVZ-35LR-WD-B-W3-1	
	1.38	3625		1.96	3.84	4.27	2.64	.79	2.36	2.76	1.97	333.0	287.54		
42	250	G 1 1/2	54,9	97,5	109,5	64,5	22	60	70	60	540	137,40	FI-RVZ-42LR-WD-B-W3-1		
1.65	3625		2.16	3.84	4.31	2.54	.87	2.36	2.76	2.36	399.6	302.28			
S	6	400	G 1/4	18,9	57	65	38	12	22	27	17	55	12,92	FI-RVZ-06SR-WD-B-W3-1	
	.24	5800		.74	2.24	2.56	1.50	.47	.87	1.06	.67	40.7	28.42		
	8	400		G 1/4	18,9	55	63	36	12	22	27	19	55		12,18
	.31	5800	.74		2.17	2.48	1.42	.47	.87	1.06	.75	40.7	26.80		
	10	400	G 3/8	21,9	57	66	37,5	12	22	27	22	80	13,30	FI-RVZ-10SR-WD-B-W3-1	
	.39	5800		.86	2.24	2.60	1.48	.47	.87	1.06	.87	59.2	29.25		
	12	400	G 3/8	21,9	59	68	39,5	12	22	27	24	80	14,64	FI-RVZ-12SR-WD-B-W3-1	
	.47	5800		.86	2.32	2.68	1.56	.47	.87	1.06	.94	59.2	32.20		
	14	400	G 1/2	26,9	64	74	42	14	27	32	27	115	20,23	FI-RVZ-14SR-WD-B-W3-1	
	.55	5800		1.06	2.52	2.91	1.65	.55	1.06	1.26	1.06	85.1	44.50		
	16	400	G 1/2	26,9	67	77	44,5	14	27	32	30	115	21,61	FI-RVZ-16SR-WD-B-W3-1	
	.63	5800		1.06	2.64	3.03	1.75	.55	1.06	1.26	1.18	85.1	47.55		
	20	400	G 3/4	31,9	79,5	90,5	53	16	46	41	36	180	46,63	FI-RVZ-20SR-WD-B-W3-1	
	.79	5800		1.26	3.13	3.56	2.09	.63	1.81	1.61	1.42	133.2	102.59		
	25	250	G 1	39,9	83	95	53	18	46	41	46	310	53,10	FI-RVZ-25SR-WD-B-W3-1	
	.98	3625		1.57	3.27	3.74	2.09	.71	1.81	1.61	1.81	229.4	116.82		
	30	250	G 1 1/4	49,9	94	107	60,5	20	50	55	50	450	85,80	FI-RVZ-30SR-WD-B-W3-1	
	1.18	3625		1.96	3.70	4.21	2.38	.79	1.97	2.17	1.97	333.0	188.76		
38	250	G 1 1/2	54,9	103,5	118,5	65,5	22	60	70	60	540	143,40	FI-RVZ-38SR-WD-B-W3-1		
1.50	3625		2.16	4.07	4.67	2.58	.87	2.36	2.76	2.36	399.6	315.48			

Connecting Parts

- Cutting Ring Type **FI-DS** Page 26
- Soft-Sealing Cutting Ring Type **FI-WDDS** Page 27
- Support Sleeve Type **FI-VH** Page 28
- STAUFF Form Ring Type **FI-AR** Page 30
- Union Nut Type **FI-M** Page 31
- 37° Flared Tube Fitting Set Type **FI-AB** Page 35

Spare Parts / Accessories

- Profile Sealing Ring Type **WDG** Page 206

¹ Approximate dimension in assembled condition.
² Weight excluding cutting ring and union nut.
³ Standard scope of delivery: Valve body only.

Male stud acc. to ISO 1179-2 (Type E)
Port acc. to ISO 1179-1

Torque recommendations for Steel mating material.

Standard seal material is NBR (Buna-N®).
Please note: Internal seals are made of FKM (Viton®).

In order to make sure that the valves will be suitable for your particular application, please contact STAUFF with details on media, operating pressure, pressure peaks, operating temperature and the expected frequency of valve actuations.



Male Stud Check Valve
Type FI-RVZ-...-M-WD • Series L / S

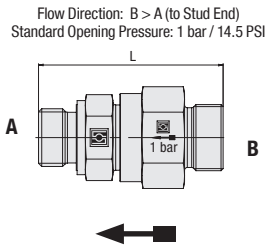
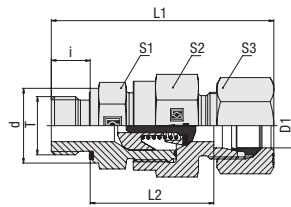

Profile Sealing Ring

Metric Parallel Thread

Series	Tube OD (mm/in)	PN (bar/PSI)	Dimensions (mm/in)										Torque (N-m/ft-lb)	Weight (kg/lbs) ca.	Ordering Codes ³
			Thread	T	d	L	L ¹	L ²	i	S1	S2	S3			
L	6	400	M 10 x 1	13,9	51	59	36	8	22	27	14	18	12,20	FI-RVZ-06LM-WD-B-W3-1	
	.24	5800		.55	2.01	2.32	1.42	.31	.87	1.06	.55	13.3	26.84		
	8	400	M 12 x 1,5	16,9	55	63	36	12	22	27	17	25	12,31	FI-RVZ-08LM-WD-B-W3-1	
	.31	5800		.67	2.17	2.48	1.42	.47	.87	1.06	.67	18.5	27.08		
	10	400	M 14 x 1,5	18,9	53	61	34	12	22	27	19	45	11,40	FI-RVZ-10LM-WD-B-W3-1	
	.39	5800		.74	2.09	2.40	1.34	.47	.87	1.06	.75	33.3	25.08		
	12	400	M 16 x 1,5	21,9	58	66	39	12	22	27	22	55	14,02	FI-RVZ-12LM-WD-B-W3-1	
	.47	5800		.86	2.28	2.60	1.54	.47	.87	1.06	.87	40.7	30.84		
	15	400	M 18 x 1,5	23,9	60	68	41	12	27	32	27	70	19,06	FI-RVZ-15LM-WD-B-W3-1	
	.59	5800		.94	2.36	2.68	1.61	.47	1.06	1.26	1.06	51.8	41.92		
	18	400	M 22 x 1,5	26,9	67	76	45,5	14	27	32	32	125	10,27	FI-RVZ-18LM-WD-B-W3-1	
	.71	5800		1.06	2.64	2.99	1.79	.55	1.06	1.26	1.26	92.5	22.59		
	22	250	M 26 x 1,5	31,9	78	87	54,5	16	46	41	36	180	46,73	FI-RVZ-22LM-WD-B-W3-1	
	.87	3625		1.26	3.07	3.43	2.15	.63	1.81	1.61	1.42	133.2	102.81		
	28	250	M 33 x 2	39,9	80	89	54,5	18	46	41	41	310	52,70	FI-RVZ-28LM-WD-B-W3-1	
	1.10	3625		1.57	3.15	3.50	2.15	.71	1.81	1.61	1.61	229.4	115.94		
	35	250	M 42 x 2	49,9	97,5	108,5	67	20	60	70	50	450	132,30	FI-RVZ-35LM-WD-B-W3-1	
	1.38	3625		1.96	3.84	4.27	2.64	.79	2.36	2.76	1.97	333.0	291.06		
	42	250	M 48 x 2	54,9	97,5	109,5	64,5	22	60	70	60	540	137,70	FI-RVZ-42LM-WD-B-W3-1	
	1.65	3625		2.16	3.84	4.31	2.54	.87	2.36	2.76	2.36	399.6	302.94		
S	6	400	M 12 x 1,5	16,9	57	65	38	12	22	27	17	35	12,66	FI-RVZ-06SM-WD-B-W3-1	
	.24	5800		.67	2.24	2.56	1.50	.47	.87	1.06	.67	25.9	27.85		
	8	400	M 14 x 1,5	18,9	55	63	36	12	22	27	19	55	12,21	FI-RVZ-08SM-WD-B-W3-1	
	.31	5800		.74	2.17	2.48	1.42	.47	.87	1.06	.75	40.7	26.87		
	10	400	M 16 x 1,5	21,9	57	66	37,5	12	22	27	22	70	6,64	FI-RVZ-10SM-WD-B-W3-1	
	.39	5800		.86	2.24	2.60	1.48	.47	.87	1.06	.87	51.8	14.61		
	12	400	M 18 x 1,5	23,9	59	68	39,5	12	24	27	24	90	15,58	FI-RVZ-12SM-WD-B-W3-1	
	.47	5800		.94	2.32	2.68	1.56	.47	.94	1.06	.94	66.6	34.28		
	14	400	M 20 x 1,5	25,9	64	74	42	14	27	32	27	125	19,98	FI-RVZ-14SM-WD-B-W3-1	
	.55	5800		1.02	2.52	2.91	1.65	.55	1.06	1.26	1.06	92.5	43.96		
	16	400	M 22 x 1,5	26,9	67	77	44,5	14	27	32	30	135	21,94	FI-RVZ-16SM-WD-B-W3-1	
	.63	5800		1.06	2.64	3.03	1.75	.55	1.06	1.26	1.18	99.9	48.26		
	20	400	M 27 x 2	31,9	78	89	51,5	16	46	41	36	180	53,51	FI-RVZ-20SM-WD-B-W3-1	
	.79	5800		1.26	3.07	3.50	2.03	.63	1.81	1.61	1.42	133.2	117.72		
	25	250	M 33 x 2	39,9	83	95	53	18	46	41	46	310	53,10	FI-RVZ-25SM-WD-B-W3-1	
	.98	3625		1.57	3.27	3.74	2.09	.71	1.81	1.61	1.81	229.4	116.82		
30	250	M 42 x 2	49,9	94	107	60,5	20	50	55	50	450	86,00	FI-RVZ-30SM-WD-B-W3-1		
1.18	3625		1.96	3.70	4.21	2.38	.79	1.97	2.17	1.97	333.0	189.20			
38	250	M 48 x 2	54,9	103,5	118,5	65,5	22	60	70	60	540	143,90	FI-RVZ-38SM-WD-B-W3-1		
1.50	3625		2.16	4.07	4.67	2.58	.87	2.36	2.76	2.36	399.6	316.58			

¹ Approximate dimension in assembled condition.

² Weight excluding cutting ring and union nut.

³ Standard scope of delivery: Valve body only.

Male stud acc. to ISO 9974-2 (Type E)

Port acc. to ISO 9974-1

Torque recommendations for Steel mating material.

Standard seal material is NBR (Buna-N®).

Please note: Internal seals are made of FKM (Viton®).

In order to make sure that the valves will be suitable for your particular application, please contact STAUFF with details on media, operating pressure, pressure peaks, operating temperature and the expected frequency of valve actuations.

Ordering Codes

***FI-RVZ*-10*L*M*-WD*-B*-W3*-1*-MS**

* Male Stud Check Valve (Flow to Stud End) **FI-RVZ**

* Outside Tube Diameter D1 (in mm) **-10**

* Series Light Series **L**
Heavy Series **S**

* Thread Type Metric Parallel Thread **M**

If required, please indicate special sizes, e.g. M12x1.5!

* Seal Type Profile Sealing Ring **-WD**

* Seal Material NBR (Buna-N®) **-B**
FKM (Viton®) **-V**
EPDM **-E**

* Material Code Steel, zinc/nickel-plated **-W3**

Please contact STAUFF for alternative materials and surface finishings.

* Opening Pressure 1 bar / 14.5 PSI **1**

Contact STAUFF for alternative opening pressures.

* Assembling / Kitting Valve body only **—**

Valve body supplied with cutting ring and union nut **-MS**

Valve body supplied with soft-sealing cutting ring and union nut **-MSV**

Connecting Parts

Cutting Ring Type **FI-DS** Page 26

Soft-Sealing Cutting Ring Type **FI-WDDS** Page 27

Support Sleeve Type **FI-VH** Page 28

STAUFF Form Ring Type **FI-AR** Page 30

Union Nut Type **FI-M** Page 31

37° Flared Tube Fitting Set Type **FI-AB** Page 35

Spare Parts / Accessories

Profile Sealing Ring Type **WDG** Page 206



Female Stud Check Valve Type FI-RVI-...-R



Standard Opening Pressure: 1 bar / 14.5 PSI

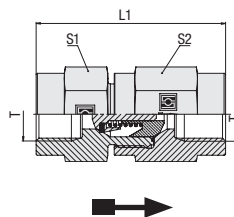

Female Whitworth Parallel Pipe Thread (BSPP)

Ordering Codes		
FI-RVI-R*1/2*-W3*-1		
* Female Stud Check Valve		FI-RVI
* Thread Type	Female Whitworth Parallel Pipe Thread (BSPP)	R
* Thread Size	acc. to dimension table	1/2
Please always indicate thread sizes, e.g. 1/2!		
* Material Code	Steel, zinc/nickel-plated	-W3
Please contact STAUFF for alternative materials and surface finishings.		
* Opening Pressure	1 bar / 14.5 PSI	1
Contact STAUFF for alternative opening pressures.		

PN (^{bar} / _{PSI})	Dimensions (^{mm} / _{in})				Weight (^{kg} / _{lbs}) ca. per 100	Ordering Codes
	Thread T	L1	S1	S2		
400	G 1/8	53	22	27	17,72	FI-RVI-R1/8-W3-1
5800		2.09	.87	1.06	38.98	
400	G 1/4	63	22	27	18,60	FI-RVI-R1/4-W3-1
5800		2.48	.87	1.06	40.91	
400	G 3/8	62	24	27	17,69	FI-RVI-R3/8-W3-1
5800		2.44	.94	1.06	38.92	
315	G 1/2	73,5	32	32	34,03	FI-RVI-R1/2-W3-1
4568		2.89	1.26	1.26	74.87	
250	G 3/4	94,5	41	46	75,00	FI-RVI-R3/4-W3-1
3625		3.72	1.61	1.81	165.00	
250	G 1	99,5	46	46	84,34	FI-RVI-R1-W3-1
3625		3.92	1.81	1.81	185.56	
250	G 1 1/4	114,5	60	60	168,10	FI-RVI-R1-1/4-W3-1
3625		4.51	2.36	2.36	369.82	
250	G 1 1/2	118,5	65	70	210,90	FI-RVI-R1-1/2-W3-1
3625		4.67	2.56	2.76	463.98	

Please note: Internal seals are made of FKM (Viton®).

In order to make sure that the valves will be suitable for your particular application, please contact STAUFF with details on media, operating pressure, pressure peaks, operating temperature and the expected frequency of valve actuations.



Check Valve Installation Kit
Type FI-VES • Design A

Standard Opening Pressure: 1 bar / 14.5 PSI

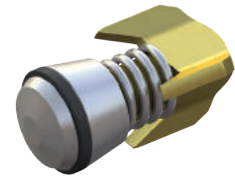
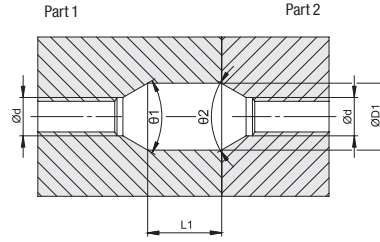
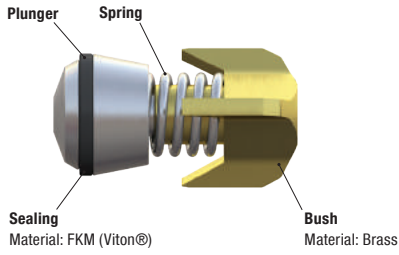

Tube OD (mm/in)	Dimensions (mm/in)						Ordering Codes
	d	D1	L1	$\varnothing 1$	$\varnothing 2$		
6	8	10	12	7,5	13,1	14,5	FI-VES-NW06-1
.24	.31	.39	.47	.30	.52	.57	
14	15	16	18	11,5	17,6	17	FI-VES-NW10-1
.55	.59	.63	.71	.45	.69	.67	

Check Valve Installation Kit
Type FI-VES • Design B

Standard Opening Pressure: 1 bar / 14.5 PSI

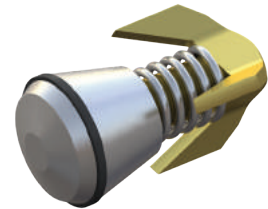
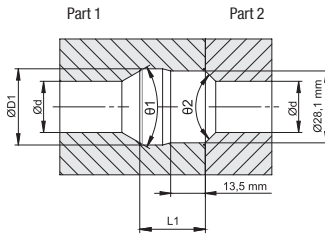
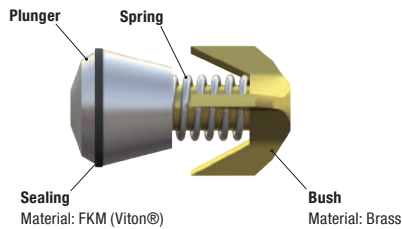

Tube OD (mm/in)	Dimensions (mm/in)						Ordering Codes
	d	D1	L1	$\varnothing 1$	$\varnothing 2$		
20	22	25	28	20	29,8	25,7	FI-VES-NW16-1
.79	.87	.98	1.10	.79	1.17	1.01	

Check Valve Installation Kit
Type FI-VES • Design C

Standard Opening Pressure: 1 bar / 14.5 PSI

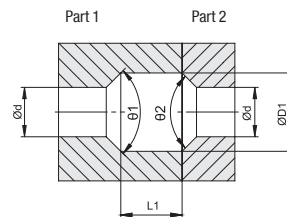
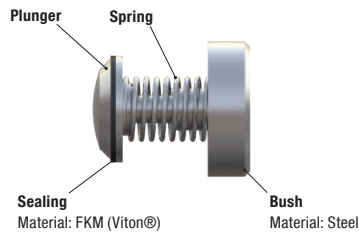

Tube OD (mm/in)	Dimensions (mm/in)						Ordering Codes
	d	D1	L1	$\varnothing 1$	$\varnothing 2$		
30		24	38	33	90	90	FI-VES-NW25-1
1.18		.94	1.50	1.30			
35	38	42	29	29	90	90	FI-VES-NW32-1
1.38	1.50	1.65	1.14	1.14			

M



Alternating Valve
Type FI-WV ▪ Series L / S

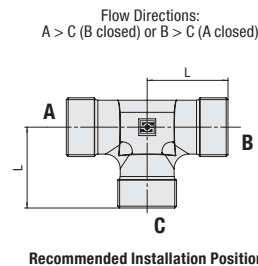
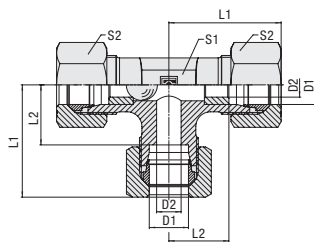

Ordering Codes

***FI-WV*-10*L*-W3*-MS**

- * Alternating Valve **FI-WV**
- * Outside Tube Diameter D1 (in mm) **-10**
- * Series Light Series **L**
Heavy Series **S**
- * Material Code Steel, zinc/nickel-plated **-W3**
- Please contact STAUFF for alternative materials and surface finishings.
- * Assembling / Kitting Valve body only **—**
- Valve body supplied with cutting rings and union nuts **-MS**
- Valve body supplied with soft-sealing cutting rings and union nuts **-MSV**

Series	Tube OD (mm/in)	PN (bar/PSI)	Dimensions (mm/in)						Weight (kg/lbs) ca. per 100 ²	Ordering Codes ³
			D1	D2	L	L1 ¹	L2	S1		
L	8	160	4	21	29	14	14	17	5,50	FI-WV-08L-W3
	.31	2320	.16	.83	1.14	.55	.55	.67	12.09	
	10	160	6	22	30	15	17	19	7,30	FI-WV-10L-W3
	.39	2320	.24	.87	1.18	.59	.67	.75	16.07	
	12	160	8	24	32	17	19	22	10,27	FI-WV-12L-W3
	.47	2320	.31	.94	1.26	.67	.75	.87	22.59	
S	15	160	9	28	36	21	19	27	10,95	FI-WV-15L-W3
	.59	2320	.35	1.10	1.42	.83	.75	1.06	24.09	
	6	160	4	23	31	16	14	17	7,04	FI-WV-06S-W3
	.24	2320	.16	.91	1.22	.63	.55	.67	15.49	
	8	160	4	24	32	17	17	19	9,49	FI-WV-08S-W3
	.31	2320	.16	.94	1.26	.67	.67	.75	20.87	
S	10	160	6	25	34	17,5	19	22	12,41	FI-WV-10S-W3
	.39	2320	.24	.98	1.34	.69	.75	.87	27.31	
	12	160	8	29	38	21,5	22	24	17,10	FI-WV-12S-W3
	.47	2320	.31	1.14	1.50	.85	.87	.94	37.62	
	16	160	10	33	43	24,5	24	30	19,60	FI-WV-16S-W3
	.63	2320	.39	1.30	1.69	.96	.94	1.18	43.13	

Connecting Parts

- Cutting Ring Type **FI-DS** Page 26
- Soft-Sealing Cutting Ring Type **FI-WDDS** Page 27
- Support Sleeve Type **FI-VH** Page 28
- STAUFF Form Ring Type **FI-AR** Page 30
- Union Nut Type **FI-M** Page 31
- 37° Flared Tube Fitting Set Type **FI-AB** Page 35

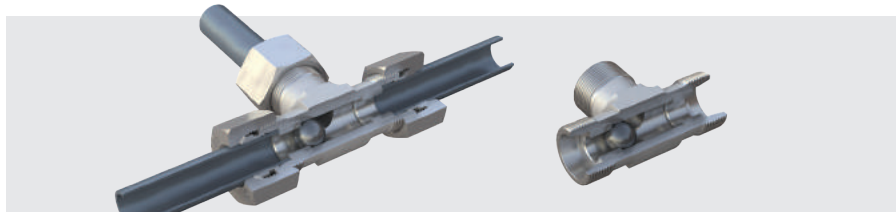

¹ Approximate dimension in assembled condition.
² Weight excluding cutting rings and union nuts.
³ Standard scope of delivery: Valve body only.

Please note: Alternating valves have been designed as switching devices for hydraulic fluids, where the non-pressurized connection of the valve is automatically closed off and sealed by a moving ball made of steel.

In order to make sure that the valves will be suitable for your particular application, please contact STAUFF with details on media, operating pressure, pressure peaks, operating temperature and the expected frequency of valve actuations.

Alternating valves are only suitable for connections that fit directly against the tube end stop of the valve body. Do not use in combination with 24° weld cone fittings, 24° DKO taper fittings and other types of fittings with no direct contact to the tube end stop of the valve body.

Do not use with compressed air or gas!



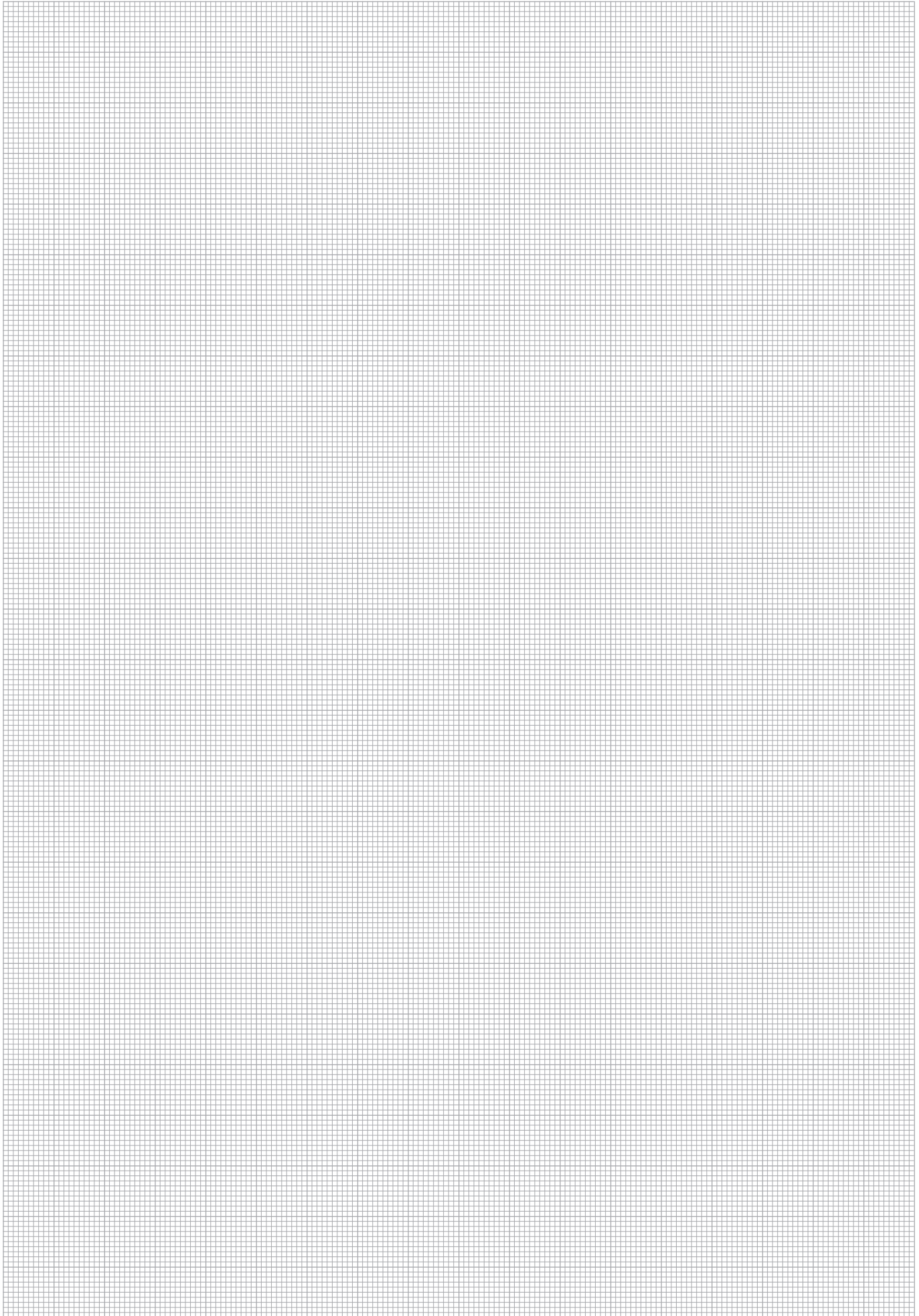

M



Kommissionier-Shuttle WALTER II

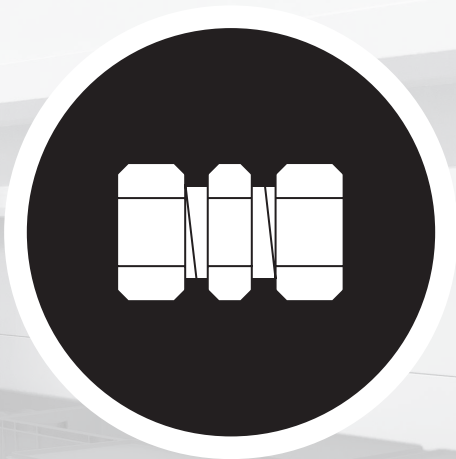

**Custom-Designed Solutions****188**

In addition to a complete range of standard components, STAUFF is also able offer individually designed special solutions according to customer's specifications or based on own developments.

Options include tube connectors with non-standard connection types and combinations, in special lengths and jump sizes or with throttle bores as well as distributors and manifolds in single-piece, soldered, brazed and welded construction.

Please do not hesitate to contact STAUFF for further information.



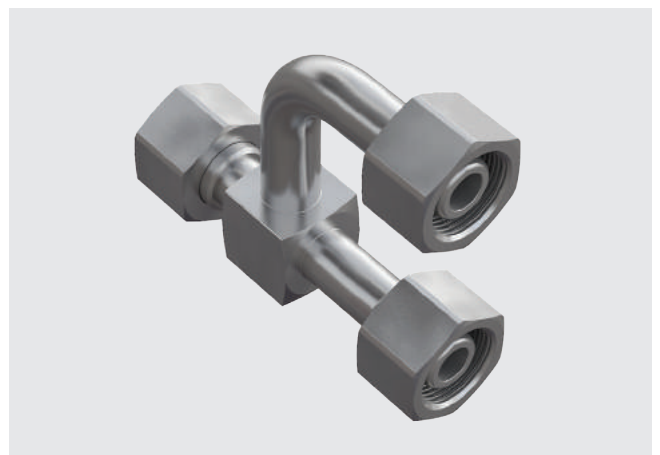
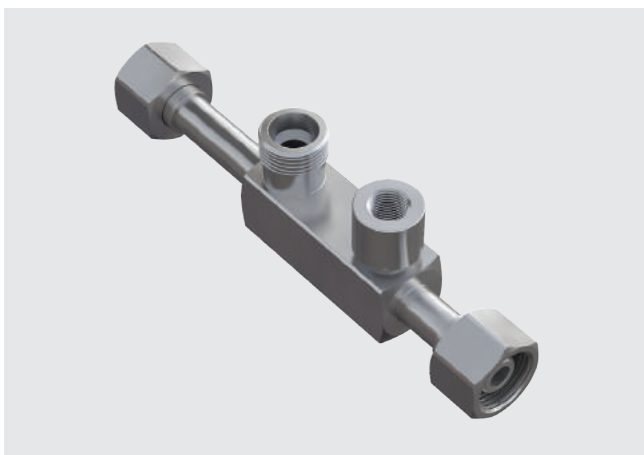

N



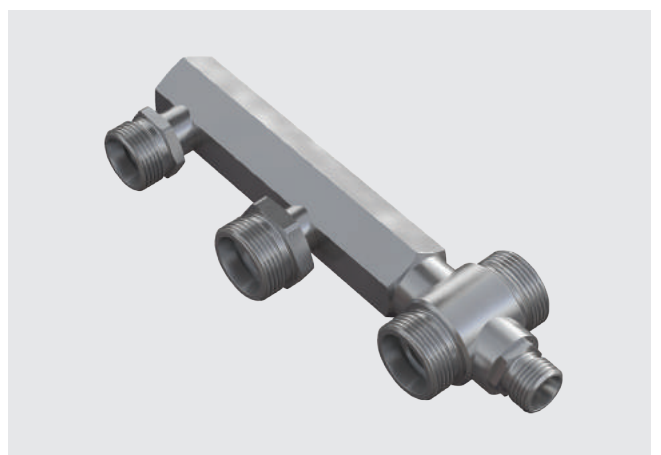
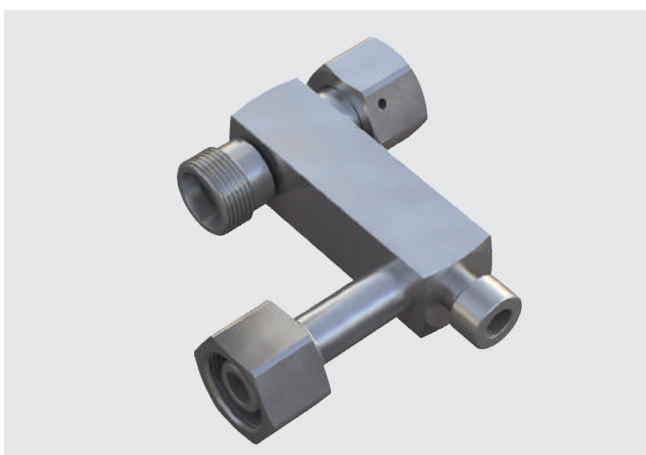
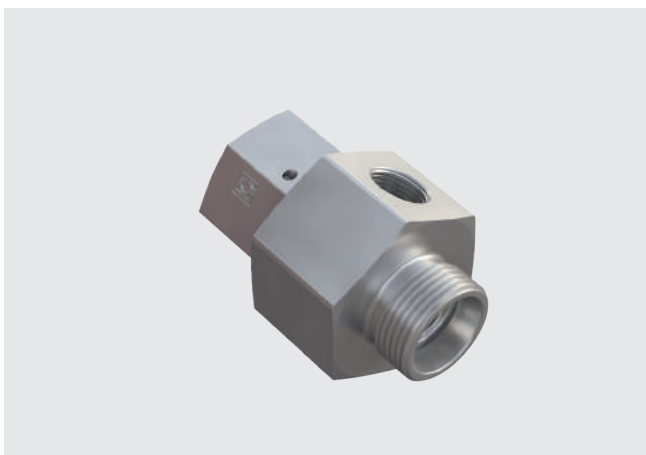



















N





	Thread Reducer FI-RED	192-195		Profile Sealing Ring WDG	206
	Whitworth Parallel Pipe Thread (BSPP) / Profile Sealing Ring FI-RED-...-R-WD	192		O-Ring O-RING	207
	Whitworth Parallel Pipe Thread (BSPP) / Metallic Sealing Edge FI-RED-...-R	194		External Metallic Sealing Ring FI-DKR	212
	Blanking Screw for Ports (Heavy Duty) FI-VSV	196-197		Retaining Ring with Captive Seal FI-DIR	213
	Whitworth Parallel Pipe Thread (BSPP) / Profile Sealing Ring FI-VSV-...-R-WD	196		Internal Metallic Sealing Ring FI-DKI	214
	Metric Parallel Thread / Profile Sealing Ring FI-VSV-...-M-WD	197		Retaining Ring (Small) FI-KR	215
	Blanking Screw for Ports FI-VS	198-201			
	Whitworth Parallel Pipe Thread (BSPP) / Profile Sealing Ring FI-VS-...-R-WD	198			
	Metric Parallel Thread / Profile Sealing Ring FI-VS-...-M-WD	199			
	Whitworth Parallel Pipe Thread (BSPP) / Metallic Sealing Edge FI-VS-...-R	200			
	Metric Parallel Thread / O-Ring FI-VS-...-M-OR	201			
	Blanking Plug with 24° Taper / O-Ring (DK0) FI-VD	202			
	Blanking Plug with Sealing Edge FI-BUZ	203			
	Blanking Plug for Tube Ends FI-VSK	204			
	Hexagon Lock Nut FI-SKM	205			



Thread Reducer
Type FI-RED-...-R-WD

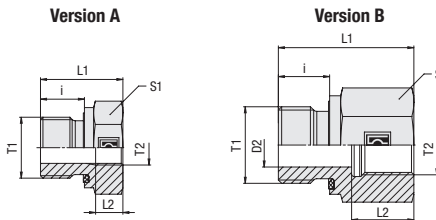

Male / Female Whitworth Parallel Pipe Thread (BSPP)

Profile Sealing Ring

Ordering Codes

***FI-RED*-R*1/2*-WD*-R*3/8*-B*-W3**

- * Thread Reducer** **FI-RED**
- * Thread Type T1** Whitworth Parallel Pipe Thread (BSPP) **R**
- * Thread Size T1** acc. to dimension table **1/2**
Please always indicate thread sizes, e.g. 1/2!
- * Seal Type** Profile Sealing Ring **-WD**
- * Thread Type T2** Whitworth Parallel Pipe Thread (BSPP) **R**
- * Thread Size T2** acc. to dimension table **3/8**
Please always indicate thread sizes, e.g. 3/8!
- * Seal Material** NBR (Buna-N®) **-B**
FKM (Viton®) **-V**
EPDM **-E**
- * Material Code** Steel, zinc/nickel-plated **-W3**
Please contact STAUFF for alternative materials and surface finishings.

PN (^{inch} / _{PSI})	Dimensions (^{mm} / _{in})							Version	Weight (^{kg} / _{lbs}) ca. per 100	Ordering Codes
	Thread T1	Thread T2	D2	L1	L2	i	S1			
630	G 1/8	G 1/4	4	31	17	8	19	B	4,30	FI-RED-R1/8-WD-R1/4-B-W3
9135			.16	1.22	.67	.31	.75		9.46	
630	G 1/8	G 3/8	4	32	17	8	24	B	6,70	FI-RED-R1/8-WD-R3/8-B-W3
9135			.16	1.26	.67	.31	.94		14.74	
400	G 1/4	G 1/8	5	29	12	12	19	B	4,40	FI-RED-R1/4-WD-R1/8-B-W3
5800			.20	1.14	.47	.47	.75		9.68	
400	G 1/4	G 3/8	5	36	17	12	24	B	7,30	FI-RED-R1/4-WD-R3/8-B-W3
5800			.20	1.42	.67	.47	.94		16.06	
400	G 1/4	G 1/2	5	40	20	12	30	B	12,80	FI-RED-R1/4-WD-R1/2-B-W3
5800			.20	1.57	.79	.47	1.18		28.16	
400	G 1/4	G 3/4	5	43	22	12	36	B	18,80	FI-RED-R1/4-WD-R3/4-B-W3
5800			.20	1.69	.87	.47	1.42		41.36	
400	G 3/8	G 1/8		22,5	8,5	12	22	A	4,20	FI-RED-R3/8-WD-R1/8-B-W3
5800				.89	.33	.47	.87		9.24	
400	G 3/8	G 1/4	8	36	17	12	22	B	7,40	FI-RED-R3/8-WD-R1/4-B-W3
5800			.31	1.42	.67	.47	.87		16.28	
630	G 3/8	G 1/2	8	41	20	12	30	B	13,60	FI-RED-R3/8-WD-R1/2-B-W3
9135			.31	1.61	.79	.47	1.18		29.92	
400	G 3/8	G 3/4	8	44	22	12	36	B	19,70	FI-RED-R3/8-WD-R3/4-B-W3
5800			.31	1.73	.87	.47	1.42		43.34	
400	G 1/2	G 1/8		24	8	14	27	A	7,00	FI-RED-R1/2-WD-R1/8-B-W3
5800				.94	.31	.55	1.06		15.40	
400	G 1/2	G 1/4		24	12	14	27	A	6,20	FI-RED-R1/2-WD-R1/4-B-W3
5800				.94	.47	.55	1.06		13.64	
400	G 1/2	G 3/8	12	37	17	14	27	B	10,40	FI-RED-R1/2-WD-R3/8-B-W3
5800			.47	1.46	.67	.55	1.06		22.88	
400	G 1/2	G 3/4	12	46	22	14	36	B	20,10	FI-RED-R1/2-WD-R3/4-B-W3
5800			.47	1.81	.87	.55	1.42		44.22	
250	G 1/2	G 1	12	49	24,5	14	41	B	25,10	FI-RED-R1/2-WD-R1-B-W3
3625			.47	1.93	.96	.55	1.61		55.22	
250	G 1/2	G 1 1/4	10	53	26,5	14	55	B	52,10	FI-RED-R1/2-WD-R1-1/4-B-W3
3625			.39	2.09	1.04	.55	2.17		114.62	

Standard seal material is NBR (Buna-N®).

Spare Parts / Accessories



Profile Sealing Ring
Type **WDG**

Page 206



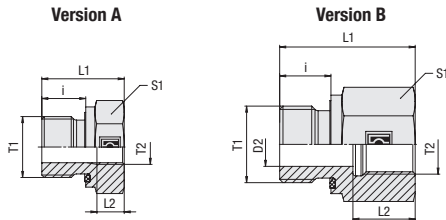

**Thread Reducer
Type FI-RED-...-R-WD**



Profile Sealing Ring Male / Female Whitworth Parallel Pipe Thread (BSPP)

PN (bar/psi)	Dimensions (mm/in)		D2	L1	L2	i	S1	Version	Weight (kg/lbs) ca. per 100	Ordering Codes
	Thread T1	Thread T2								
315	G 3/4	G 1/4		26	12,5	16	32	A	10,90	FI-RED-R3/4-WD-R1/4-B-W3
4567,5				1.02	.49	.63	1.26		23.98	
315	G 3/4	G 3/8		26	12,5	16	32	A	9,40	FI-RED-R3/4-WD-R3/8-B-W3
4567,5				1.02	.49	.63	1.26		20.68	
400	G 3/4	G 1/2	16	43	20	16	32	B	16,90	FI-RED-R3/4-WD-R1/2-B-W3
5800			.63	1.69	.79	.63	1.26		37.18	
400	G 3/4	G 1	16	51	24,5	16	41	B	26,60	FI-RED-R3/4-WD-R1-B-W3
5800			.63	2.01	.96	.63	1.61		58.52	
250	G 3/4	G 1 1/4	16	55	26,5	16	55	B	52,70	FI-RED-R3/4-WD-R1-1/4-B-W3
3625			.63	2.17	1.04	.63	2.17		115.94	
250	G 3/4	G 1 1/2	16	57	28,5	16	60	B	61,10	FI-RED-R3/4-WD-R1-1/2-B-W3
3625			.63	2.24	1.12	.63	2.36		134.42	
400	G 1	G 1/4		29	12,5	18	41	A	20,70	FI-RED-R1-WD-R1/4-B-W3
5800				1.14	.49	.71	1.61		45.54	
400	G 1	G 3/8		29	12,5	18	41	A	19,10	FI-RED-R1-WD-R3/8-B-W3
5800				1.14	.49	.71	1.61		42.02	
400	G 1	G 1/2		29	14,5	18	41	A	16,80	FI-RED-R1-WD-R1/2-B-W3
5800				1.14	.57	.71	1.61		36.96	
400	G 1	G 3/4	20	49	22	18	41	B	31,30	FI-RED-R1-WD-R3/4-B-W3
5800			.79	1.93	.87	.71	1.61		68.86	
250	G 1	G 1 1/4	20	57	26,5	18	55	B	58,80	FI-RED-R1-WD-R1-1/4-B-W3
3625			.79	2.24	1.04	.71	2.17		129.36	
250	G 1	G 1 1/2	20	59	28,5	18	60	B	63,90	FI-RED-R1-WD-R1-1/2-B-W3
3625			.79	2.32	1.12	.71	2.36		140.58	
315	G 1 1/4	G 1/2		32	14,5	20	50	A	33,00	FI-RED-R1-1/4-WD-R1/2-B-W3
4567,5				1.26	.57	.79	1.97		72.60	
315	G 1 1/4	G 3/4		32	16,5	20	50	A	28,30	FI-RED-R1-1/4-WD-R3/4-B-W3
4567,5				1.26	.65	.79	1.97		62.26	
315	G 1 1/4	G 1	25	53	24,5	20	50	B	50,60	FI-RED-R1-1/4-WD-R1-B-W3
4567,5			.98	2.09	.96	.79	1.97		111.32	
250	G 1 1/4	G 1 1/2	25	60	28,5	20	60	B	67,30	FI-RED-R1-1/4-WD-R1-1/2-B-W3
3625			.98	2.36	1.12	.79	2.36		148.06	
250	G 1 1/2	G 1/2		36	14,5	22	55	A	49,60	FI-RED-R1-1/2-WD-R1/2-B-W3
3625				1.42	.57	.87	2.17		109.12	
250	G 1 1/2	G 3/4		36	16	22	55	A	44,40	FI-RED-R1-1/2-WD-R3/4-B-W3
3625				1.42	.63	.87	2.17		97.68	
250	G 1 1/2	G 1		36	18,5	22	55	A	36,90	FI-RED-R1-1/2-WD-R1-B-W3
3625				1.42	.73	.87	2.17		81.18	
250	G 1 1/2	G 1 1/4		58	26,5	22	55	A	57,80	FI-RED-R1-1/2-WD-R1-1/4-B-W3
3625				2.28	1.04	.87	2.17		127.16	
160	G 2	G 1 1/4		48	20,5	24	75	A	93,70	FI-RED-R2-WD-R1-1/4-B-W3
2320				1.89	.81	.94	2.95		206.14	
160	G 2	G 1 1/2	40	65	29	24	75	B	132,20	FI-RED-R2-WD-R1-1/2-B-W3
2320			1.57	2.56	1.14	.94	2.95		290.84	

Standard seal material is NBR (Buna-N®).

Ordering Codes

***FI-RED*-R*1/2*-WD*-R*3/8*-B*-W3**

- * Thread Reducer FI-RED
- * Thread Type T1 Whitworth Parallel Pipe Thread (BSPP) R
- * Thread Size T1 acc. to dimension table 1/2
- Please always indicate thread sizes, e.g. 1/2!
- * Seal Type Profile Sealing Ring -WD
- * Thread Type T2 Whitworth Parallel Pipe Thread (BSPP) R
- * Thread Size T2 acc. to dimension table 3/8
- Please always indicate thread sizes, e.g. 3/8!
- * Seal Material NBR (Buna-N®) -B
FKM (Viton®) -V
EPDM -E
- * Material Code Steel, zinc/nickel-plated -W3

Spare Parts / Accessories



Profile Sealing Ring
Type **WDG**

Page 206



**Thread Reducer
Type FI-RED-...-R**

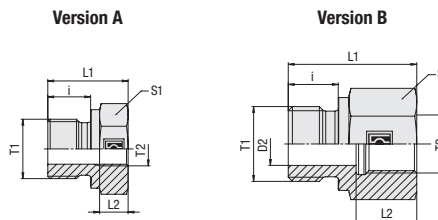

Male / Female Whitworth Parallel Pipe Thread (BSPP)

Metallic Sealing Edge

Ordering Codes

***FI-RED*-R*1/2*-R*3/8*-B*-W3**

- * Thread Reducer** **FI-RED**
- * Thread Type T1** Whitworth Parallel Pipe Thread (BSPP) **R**
- * Thread Size T1** acc. to dimension table **1/2**
Please always indicate thread sizes, e.g. 1/2!
- * Thread Type T2** Whitworth Parallel Pipe Thread (BSPP) **R**
- * Thread Size T2** acc. to dimension table **3/8**
Please always indicate thread sizes, e.g. 3/8!
- * Seal Material** NBR (Buna-N®) **-B**
FKM (Viton®) **-V**
EPDM **-E**
- * Material Code** Steel, zinc/nickel-plated **-W3**
Please contact STAUFF for alternative materials and surface finishings.

PN (^{bar} / _{PSI})	Dimensions (^{mm} / _{in})							Version	Weight (^{kg} / _{lbs}) ca. per 100	Ordering Codes
	Thread T1	Thread T2	D2	L1	L2	i	S1			
630	G 1/8	G 1/4	4	31	17	8	19	B	4,25	FI-RED-R1/8-R1/4-W3
9135			.16	1.22	.67	.31	.75		9.35	
630	G 1/8	G 3/8	4	32	17	8	24	B	6,15	FI-RED-R1/8-R3/8-W3
9135			.16	1.26	.67	.31	.94		13.53	
400	G 1/4	G 1/8	5	28	12	12	19	B	3,91	FI-RED-R1/4-R1/8-W3
5800			.20	1.10	.47	.47	.75		8.60	
630	G 1/4	G 3/8	5	36	17	12	24	B	6,80	FI-RED-R1/4-R3/8-W3
9135			.20	1.42	.67	.47	.94		14.96	
630	G 1/4	G 1/2	5	40	20	12	30	B	11,80	FI-RED-R1/4-R1/2-W3
9135			.20	1.57	.79	.47	1.18		25.96	
630	G 1/4	G 3/4	5	43	22	12	36	B	17,50	FI-RED-R1/4-R3/4-W3
9135			.20	1.69	.87	.47	1.42		38.50	
400	G 3/8	G 1/8		22,5	8	12	22	A	4,20	FI-RED-R3/8-R1/8-W3
5800				.89	.31	.47	.87		9.24	
400	G 3/8	G 1/4	8	36	17	12	22	B	7,05	FI-RED-R3/8-R1/4-W3
5800			.31	1.42	.67	.47	.87		15.51	
400	G 3/8	G 1/2	8	41	20	12	30	B	17,80	FI-RED-R3/8-R1/2-W3
5800			.31	1.61	.79	.47	1.18		39.18	
630	G 3/8	G 3/4	8	44	22	12	36	B	18,40	FI-RED-R3/8-R3/4-W3
9135			.31	1.73	.87	.47	1.42		40.48	
400	G 1/2	G 1/8		24	8	14	27	A	6,58	FI-RED-R1/2-R1/8-W3
5800				.94	.31	.55	1.06		14.48	
400	G 1/2	G 1/4		24	12,5	14	27	A	5,53	FI-RED-R1/2-R1/4-W3
5800				.94	.49	.55	1.06		12.17	
400	G 1/2	G 3/8	12	36	17	14	27	B	9,30	FI-RED-R1/2-R3/8-W3
5800			.47	1.42	.67	.55	1.06		20.46	
400	G 1/2	G 3/4	12	46	22	14	36	B	18,50	FI-RED-R1/2-R3/4-W3
5800			.47	1.81	.87	.55	1.42		40.70	
400	G 1/2	G 1	12	49	24,5	14	41	B	22,70	FI-RED-R1/2-R1-W3
5800			.47	1.93	.96	.55	1.61		49.94	
400	G 1/2	G 1 1/4	12	53	26,5	14	55	B	48,10	FI-RED-R1/2-R1-1/4-W3
5800			.47	2.09	1.04	.55	2.17		105.82	



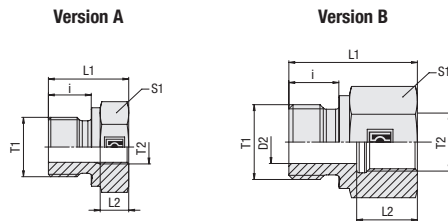

Thread Reducer Type FI-RED-...-R



Metallic Sealing Edge

Male / Female Whitworth Parallel Pipe Thread (BSPP)

PN (^{bar} /psi)	Dimensions (^{mm} / _{in})		D2	L1	L2	i	S1	Version	Weight (^{kg} /lbs) ca. per 100	Ordering Codes
	Thread T1	Thread T2								
400	G 3/4	G 1/4		26	12,5	16	32	A	10,20	FI-RED-R3/4-R1/4-W3
5800				1.02	.49	.63	1.26		22.44	
315	G 3/4	G 3/8		26	12,5	16	32	A	8,70	FI-RED-R3/4-R3/8-W3
4567,5				1.02	.49	.63	1.26		19.14	
315	G 3/4	G 1/2	16	41	20	16	32	B	14,60	FI-RED-R3/4-R1/2-W3
4567,5			.63	1.61	.79	.63	1.26		32.12	
315	G 3/4	G 1	16	51	24,5	16	41	B	24,60	FI-RED-R3/4-R1-W3
4567,5			.63	2.01	.96	.63	1.61		54.12	
400	G 3/4	G 1 1/4	16	55	26,5	16	55	B	48,40	FI-RED-R3/4-R1-1/4-W3
5800			.63	2.17	1.04	.63	2.17		106.48	
250	G 3/4	G 1 1/2	16	57	28,5	16	60	B	57,00	FI-RED-R3/4-R1-1/2-W3
3625			.63	2.24	1.12	.63	2.36		125.40	
250	G 1	G 1/4		29	12,5	18	41	A	19,10	FI-RED-R1-R1/4-W3
3625				1.14	.49	.71	1.61		42.02	
315	G 1	G 3/8		29	12,5	18	41	A	17,90	FI-RED-R1-R3/8-W3
4567,5				1.14	.49	.71	1.61		39.38	
315	G 1	G 1/2		29	14,5	18	41	A	15,40	FI-RED-R1-R1/2-W3
4567,5				1.14	.57	.71	1.61		33.88	
315	G 1	G 3/4	20	47	22	18	41	B	27,60	FI-RED-R1-R3/4-W3
4567,5			.79	1.85	.87	.71	1.61		60.72	
315	G 1	G 1 1/4	20	57	26,5	18	55	B	52,10	FI-RED-R1-R1-1/4-W3
4567,5			.79	2.24	1.04	.71	2.17		114.62	
250	G 1 1/4	G 1/2		32	14,5	20	50	A	31,30	FI-RED-R1-1/4-R1/2-W3
3625				1.26	.57	.79	1.97		68.86	
315	G 1 1/4	G 3/4		32	16,5	20	50	A	26,50	FI-RED-R1-1/4-R3/4-W3
4567,5				1.26	.65	.79	1.97		58.30	
315	G 1 1/2	G 1/2		36	14,5	22	55	A	47,30	FI-RED-R1-1/2-R1/2-W3
4567,5				1.42	.57	.87	2.17		104.06	
250	G 1 1/2	G 3/4		36	14,5	22	55	A	41,90	FI-RED-R1-1/2-R3/4-W3
3625				1.42	.57	.87	2.17		92.18	
250	G 1 1/2	G 1		36	18	22	55	A	34,10	FI-RED-R1-1/2-R1-W3
3625				1.42	.71	.87	2.17		75.02	
250	G 2	G 1 1/4		62	20,5	24	70	A	99,50	FI-RED-R2-R1-1/4-W3
3625				2.44	.81	.94	2.76		218.90	
160	G 2	G 1 1/2	40	62	28,5	28,5	70	B	107,30	FI-RED-R2-R1-1/2-W3
2320			1.57	2.44	1.12	1.12	2.76		236.06	

Ordering Codes

FI-RED-R*1/2*-R*3/8*-B*-W3

* Thread Reducer		FI-RED
* Thread Type T1	Whitworth Parallel Pipe Thread (BSPP)	R
* Thread Size T1	acc. to dimension table	1/2
Please always indicate thread sizes, e.g. 1/2!		
* Thread Type T2	Whitworth Parallel Pipe Thread (BSPP)	R
* Thread Size T2	acc. to dimension table	3/8
Please always indicate thread sizes, e.g. 3/8!		
* Seal Material	NBR (Buna-N®) FKM (Viton®) EPDM	-B -V -E
* Material Code	Steel, zinc/nickel-plated	-W3

Please contact STAUFF for alternative materials and surface finishings.



Blanking Screw for Ports (Heavy Duty) Type FI-VSV-...-R-WD

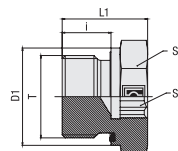

Ordering Codes

FI-VSV-R*1/2*-WD*-B*-W3

- * Blanking Screw for Ports **FI-VSV**
- * Thread Type Whitworth Parallel Pipe Thread (BSPP) **R**
- * Thread Size acc. to dimension table **1/2**
- Please always indicate thread sizes, e.g. 1/2!
- * Seal Type Profile Sealing Ring **-WD**
- * Seal Material NBR (Buna-N®) **-B**
FKM (Viton®) **-V**
EPDM **-E**
- * Material Code Steel, zinc/nickel-plated **-W3**

Please contact STAUFF for alternative materials and surface finishings.

Whitworth Parallel Pipe Thread (BSPP)

Profile Sealing Ring

PN (^{bar} /PSI)	Dimensions (^{mm} / ⁱⁿ)						Torque (^{N·m} / ^{ft·lb})	Weight (^{kg} / ^{lbs}) ca. per 100	Ordering Codes
	Thread T	D1	L1	i	S1	S2			
400	G 1/8	14	18	8	5	14	18	1,56	FI-VSV-R1/8-WD-B-W3
5800		.55	.71	.31	.20	.55	13.3	3.43	
400	G 1/4	19	20	12	6	19	33	2,73	FI-VSV-R1/4-WD-B-W3
5800		.75	.79	.47	.24	.75	24.4	6.00	
400	G 3/8	22	22	12	8	22	70	4,48	FI-VSV-R3/8-WD-B-W3
5800		.87	.87	.47	.31	.87	51.8	9.85	
400	G 1/2	27	24	14	10	27	90	7,27	FI-VSV-R1/2-WD-B-W3
5800		1.06	.94	.55	.39	1.06	66.6	15.98	
400	G 3/4	32	28	16	12	32	181	13,02	FI-VSV-R3/4-WD-B-W3
5800		1.26	1.10	.63	.47	1.26	133.2	28.64	
400	G 1	46	33	18	17	46	250	23,80	FI-VSV-R1-WD-B-W3
5800		1.81	1.30	.71	.67	1.81	185.0	52.36	
400	G 1 1/4	57	38	20	22	60	400	42,00	FI-VSV-R1 1/4-WD-B-W3
5800		2.24	1.50	.79	.87	2.36	296.0	92.40	
400	G 1 1/2	64	40	22	24	65	500	55,60	FI-VSV-R1 1/2-WD-B-W3
5800		2.52	1.57	.87	.94	2.56	370.0	122.32	

Standard seal material is NBR (Buna-N®).

Male stud acc. to ISO 1179-2 (Type E)
Port acc. to ISO 1179-1

Torque recommendations for Steel mating material.

Spare Parts / Accessories



Profile Sealing Ring
Type **WDG**

Page 206



Blanking Screw for Ports (Heavy Duty)
Type FI-VSV-...-M-WD

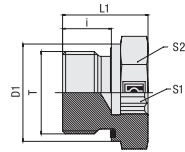

Profile Sealing Ring

Metric Parallel Thread

PN (bar/PSI)	Dimensions (mm/in)						Torque (N-m/ft-lb)	Weight (kg/lbs) Ca.	Ordering Codes
	Thread T	D1	L1	i	S1	S2			
400	M 10 x 1	14	18	8	5	14	12	1,58	FI-VSV-M10x1-WD-B-W3
5800		.55	.71	.31	.20	.55	8.9	3.47	
400	M 12 x 1,5	17	20	12	6	17	25	2,13	FI-VSV-M12x1.5-WD-B-W3
5800		.67	.79	.47	.24	.67	18.5	4.69	
400	M 14 x 1,5	19	22	12	6	19	45	3,35	FI-VSV-M14x1.5-WD-B-W3
5800		.75	.87	.47	.24	.75	33.3	7.38	
400	M 16 x 1,5	22	22	12	8	22	55	4,30	FI-VSV-M16x1.5-WD-B-W3
5800		.87	.87	.47	.31	.87	40.7	9.46	
400	M 18 x 1,5	24	22	12	8	24	70	5,38	FI-VSV-M18x1.5-WD-B-W3
5800		.94	.87	.47	.31	.94	51.8	11.83	
400	M 20 x 1,5	27	22	14	10	27	80	6,09	FI-VSV-M20x1.5-WD-B-W3
5800		1.06	.87	.55	.39	1.06	59.2	13.39	
400	M 22 x 1,5	27	22	14	10	27	125	6,77	FI-VSV-M22x1.5-WD-B-W3
5800		1.06	.87	.55	.39	1.06	92.5	14.89	
400	M 26 x 1,5	32	30	16	12	32	180	14,33	FI-VSV-M26x1.5-WD-B-W3
5800		1.26	1.18	.63	.47	1.26	133.2	31.53	
400	M 27 x 2	32	28	16	12	32	180	13,23	FI-VSV-M27x2-WD-B-W3
5800		1.26	1.10	.63	.47	1.26	133.2	29.11	
400	M 33 x 2	40	33	18	17	41	250	29,32	FI-VSV-M33x2-WD-B-W3
5800		1.57	1.30	.71	.67	1.61	185.0	64.50	
400	M 42 x 2	50	38	20	22	50	400	57,35	FI-VSV-M42x2-WD-B-W3
5800		1.97	1.50	.79	.87	1.97	296.0	126.17	
400	M 48 x 2	55	40	22	24	55	500	73,79	FI-VSV-M48x2-WD-B-W3
5800		2.17	1.57	.87	.94	2.17	370.0	162.33	

Ordering Codes

***FI-VSV*-M*12x1.5*-WD*-B*-W3**

- * Blanking Screw for Ports FI-VSV
- * Thread Type Metric Parallel Thread **M**
- * Thread Size acc. to dimension table **12x1.5**
- Please always indicate thread sizes, e.g. 12x1.5!
- * Seal Type Profile Sealing Ring **-WD**
- * Seal Material NBR (Buna-N®) **-B**
- FKM (Viton®) **-V**
- EPDM **-E**
- * Material Code Steel, zinc/nickel-plated **-W3**

Please contact STAUFF for alternative materials and surface finishings.

Spare Parts / Accessories



Profile Sealing Ring
Type **WDG**

Page 206

Standard seal material is NBR (Buna-N®).

Male stud acc. to ISO 9974-2 (Type E)
Port acc. to ISO 9974-1

Torque recommendations for Steel mating material.



Blanking Screw for Ports Type FI-VS-...-R-WD

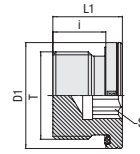

Ordering Codes

***FI-VS*-R*1/2*-WD*-B*-W3**

- * Blanking Screw for Ports **FI-VS**
 - * Thread Type Whitworth Parallel Pipe Thread (BSPP) **R**
 - * Thread Size acc. to dimension table **1/2**
 - Please always indicate thread sizes, e.g. 1/2!
 - * Seal Type Profile Sealing Ring **-WD**
 - * Seal Material NBR (Buna-N®) **-B**
FKM (Viton®) **-V**
EPDM **-E**
 - * Material Code Steel, zinc/nickel-plated **-W3**
- Please contact STAUFF for alternative materials and surface finishings.

Whitworth Parallel Pipe Thread (BSPP)

Profile Sealing Ring

PN (^{inch} / _{PSI})	Dimensions (^{mm} / _{in})					Torque (^{N-m} / _{ft-lb})	Weight (^{kg} / _{lbs}) ca. per 100	Ordering Codes
	Thread T	D1	L1	i	S1			
400	G 1/8	14	12,3	8	5	15	0,70	FI-VS-R1/8-WD-B-W3
5800		.55	.48	.31	.20	11.1	1.54	
400	G 1/4	19	17,3	12	6	25	1,90	FI-VS-R1/4-WD-B-W3
5800		.75	.68	.47	.24	18.5	4.18	
400	G 3/8	22	17,3	12	8	50	2,70	FI-VS-R3/8-WD-B-W3
5800		.87	.68	.47	.31	37.0	5.94	
400	G 1/2	27	19,3	14	10	70	4,60	FI-VS-R1/2-WD-B-W3
5800		1.06	.76	.55	.39	51.8	10.12	
400	G 3/4	32	21,3	16	12	120	8,00	FI-VS-R3/4-WD-B-W3
5800		1.26	.84	.63	.47	88.8	17.60	
400	G 1	40	22,8	16	17	200	12,80	FI-VS-R1-WD-B-W3
5800		1.57	.90	.63	.67	148.0	28.16	
315	G 1 1/4	50	22,8	16	22	320	19,90	FI-VS-R1-1/4-WD-B-W3
4568		1.97	.90	.63	.87	236.8	43.78	
315	G 1 1/2	55	22,8	16	24	400	26,20	FI-VS-R1-1/2-WD-B-W3
4568		2.17	.90	.63	.94	296.0	57.64	

Standard seal material is NBR (Buna-N®).

Male stud acc. to ISO 1179-2 (Type E)
Port acc. to ISO 1179-1

Torque recommendations for Steel mating material.

Spare Parts / Accessories



Profile Sealing Ring
Type **WDG**

Page 206



Blanking Screw for Ports
Type FI-VS-...-M-WD

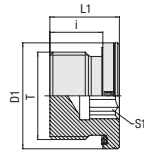

Profile Sealing Ring

Metric Parallel Thread

PN (bar/psi)	Dimensions (mm/in)					Torque (N-m/ft-lb)	Weight (kg/lbs) Ca. per 100	Ordering Codes
	Thread T	D1	L1	i	S1			
400	M 8 x 1	12	12	8	4	10	0,50	FI-VS-M8x1-WD-B-W3
5800		.47	.47	.31	.16	7.4	1.10	
400	M 10 x 1	14	12,3	8	5	12	0,70	FI-VS-M10x1-WD-B-W3
5800		.55	.48	.31	.20	8.9	1.54	
400	M 12 x 1,5	17	17,3	12	6	23	1,50	FI-VS-M12x1.5-WD-B-W3
5800		.67	.68	.47	.24	17.0	3.30	
400	M 14 x 1,5	19	17,3	12	6	30	2,00	FI-VS-M14x1.5-WD-B-W3
5800		.75	.68	.47	.24	22.2	4.40	
400	M 16 x 1,5	22	17,3	12	8	50	2,60	FI-VS-M16x1.5-WD-B-W3
5800		.87	.68	.47	.31	37.0	5.72	
400	M 18 x 1,5	24	17,3	12	8	65	3,30	FI-VS-M18x1.5-WD-B-W3
5800		.94	.68	.47	.31	48.1	7.26	
400	M 20 x 1,5	26	19,3	14	10	80	4,30	FI-VS-M20x1.5-WD-B-W3
5800		1.02	.76	.55	.39	59.2	9.46	
400	M 22 x 1,5	27	19,3	14	10	90	5,10	FI-VS-M22x1.5-WD-B-W3
5800		1.06	.76	.55	.39	66.6	11.22	
400	M 26 x 1,5	32	21,3	16	12	100	8,00	FI-VS-M26x1.5-WD-B-W3
5800		1.26	.84	.63	.47	74.0	17.60	
400	M 27 x 2	32	21,3	16	12	130	8,20	FI-VS-M27x2-WD-B-W3
5800		1.26	.84	.63	.47	96.2	18.04	
400	M 33 x 2	40	22,8	16	17	250	13,10	FI-VS-M33x2-WD-B-W3
5800		1.57	.90	.63	.67	185.0	28.82	
250	M 42 x 2	50	22,8	16	22	310	20,40	FI-VS-M42x2-WD-B-W3
3625		1.97	.90	.63	.87	229.4	44.88	
250	M 48 x 2	55	22,8	16	24	380	26,90	FI-VS-M48x2-WD-B-W3
3625		2.17	.90	.63	.94	281.2	59.18	

Ordering Codes

***FI-VS*-M*12x1.5*-WD*-B*-W3**

- * Blanking Screw for Ports FI-VS
- * Thread Type Metric Parallel Thread M
- * Thread Size acc. to dimension table 12x1.5
- Please always indicate thread sizes, e.g. 12x1.5!
- * Seal Type Profile Sealing Ring -WD
- * Seal Material NBR (Buna-N®) -B
FKM (Viton®) -V
EPDM -E
- * Material Code Steel, zinc/nickel-plated -W3

Please contact STAUFF for alternative materials and surface finishings.

Spare Parts / Accessories



Profile Sealing Ring
Type WDG

Page 206

Standard seal material is NBR (Buna-N®).

Male stud acc. to ISO 9974-2 (Type E)
Port acc. to ISO 9974-1

Torque recommendations for Steel mating material.



Blanking Screw for Ports Type FI-VS-...-R

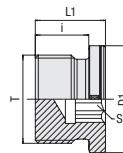

Ordering Codes

FI-VS-R*1/2*-W3

* Straight Male Stud Fitting

* Thread Type Whitworth Parallel Pipe Thread (BSPP)

* Thread Size acc. to dimension table

Please always indicate thread sizes, e.g. 1/2!

* Material Code Steel, zinc/nickel-plated

Please contact STAUFF for alternative materials and surface finishings.

FI-GE

R

1/2

-W3

Whitworth Parallel Pipe Thread (BSPP)

Metallic Sealing Edge

PN (^{bar} /PSI)	Dimensions (mm/in)					Torque (N-m/ft-lb)	Weight (kg/lbs) ca. per 100	Ordering Codes
	Thread T	D1	L1	i	S1			
400	G 1/8	14	12,3	8	5	25	0,70	FI-VS-R1/8-W3
5800		.55	.48	.31	.20	18.5	1.54	
400	G 1/4	18	17,3	12	6	40	1,80	FI-VS-R1/4-W3
5800		.71	.68	.47	.24	29.6	3.96	
400	G 3/8	22	17,3	12	8	95	2,70	FI-VS-R3/8-W3
5800		.87	.68	.47	.31	70.3	5.94	
400	G 1/2	26	19,3	14	10	130	4,60	FI-VS-R1/2-W3
5800		1.02	.76	.55	.39	96.2	10.12	
400	G 3/4	32	21,3	16	12	250	7,90	FI-VS-R3/4-W3
5800		1.26	.84	.63	.47	185.0	17.38	
400	G 1	39	22,8	16	17	400	12,80	FI-VS-R1-W3
5800		1.54	.90	.63	.67	296.0	28.16	
315	G 1 1/4	49	22,8	16	22	600	19,30	FI-VS-R1-1/4-W3
4567,5		1.93	.90	.63	.87	444.0	42.46	
315	G 1 1/2	55	22,8	16	24	800	26,10	FI-VS-R1-1/2-W3
4567,5		2.17	.90	.63	.94	592.0	57.42	

Male stud acc. to DIN 3852-2 (Form B) / ISO 1179-4 (Type B)
Port acc. to DIN 3852-2 (Form X) / ISO 1179-1

Torque recommendations for Steel mating material.



Blanking Screw for Ports
Type FI-VS-...-M-OR

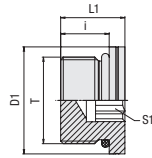

O-Ring

Metric Parallel Thread

PN (bar/psi)	Dimensions (mm/in)					Torque (N·m/ft·lb)	Weight (kg/lbs) Ca. per 100	Ordering Codes
	Thread T	D1	L1	i	S1			
630	M 10 x 1	13,8	13,5	9,5	5	15	0,8	FI-VS-M10x1-OR-B-W3
9135		.54	.53	.37	.20	11.1	1.76	
630	M 12 x 1,5	16,8	15,5	11	6	22	1,4	FI-VS-M12x1.5-OR-B-W3
9135		.66	.61	.43	.24	16.3	3.08	
630	M 14 x 1,5	18,8	16	11	6	45	2,0	FI-VS-M14x1.5-OR-B-W3
9135		.74	.63	.43	.24	33.3	4.40	
630	M 16 x 1,5	21,8	17,5	12,5	8	55	2,7	FI-VS-M16x1.5-OR-B-W3
9135		.86	.69	.49	.31	40.7	5.94	
630	M 18 x 1,5	23,8	19	14	8	70	3,8	FI-VS-M18x1.5-OR-B-W3
9135		.94	.75	.55	.31	51.8	8.36	
630	M 22 x 1,5	26,8	20	15	10	100	5,5	FI-VS-M22x1.5-OR-B-W3
9135		1.06	.79	.59	.39	74.0	12.10	
400	M 26 x 1,5	31,8	21	16	12	170	7,7	FI-VS-M26x1.5-OR-B-W3
5800		1.25	.83	.63	.47	125.8	16.94	
400	M 27 x 2	31,8	23,5	18,5	12	180	9,4	FI-VS-M27x2-OR-B-W3
5800		1.25	.93	.73	.47	133.2	20.68	
400	M 33 x 2	40,8	24,5	18,5	14	215	15,6	FI-VS-M33x2-OR-B-W3
5800		1.61	.96	.73	.55	159.1	34.32	
400	M 42 x 2	49,8	25	19	22	330	24,5	FI-VS-M42x2-OR-B-W3
5800		1.96	.98	.75	.87	244.2	53.90	
400	M 48 x 2	54,8	27,5	21,5	24	420	37,1	FI-VS-M48x2-OR-B-W3
5800		2.16	1.08	.85	.94	310.8	81.62	

Standard seal material is NBR (Buna-N®).

Male stud acc. to ISO 6149-2/-3
Port acc. to ISO 6149-1

Torque recommendations for Steel mating material.

Ordering Codes

***FI-VS*-M*12x1.5*-OR*-B*-W3**

- * Blanking Screw for Ports FI-VS
- * Thread Type Metric Parallel Thread **M**
- * Thread Size acc. to dimension table **12x1.5**
- Please always indicate thread sizes, e.g. 12x1.5!
- * Seal Type O-Ring **-OR**
- * Seal Material NBR (Buna-N®) **-B**
FKM (Viton®) **-V**
EPDM **-E**
- * Material Code Steel, zinc/nickel-plated **-W3**

Please contact STAUFF for alternative materials and surface finishings.

Spare Parts / Accessories



O-Ring
Type **O-RING**

Page 207



Blanking Plug with 24° Taper / O-Ring (DKO) Type FI-VD ▪ Series L / S

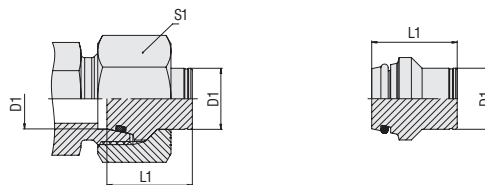

Ordering Codes

FI-VD-10*L*-B*-W3*-M

* Blanking Plug with 24° Taper / O-Ring (DKO)	FI-VD
* Outside Tube Diameter D1 (in mm)	-10
* Series	Light Series L Heavy Series S
* Seal Material	NBR (Buna-N®) -B FKM (Viton®) -V EPDM -E
* Material Code	Steel, zinc/nickel-plated -W3
Please contact STAUFF for alternative materials and surface finishings.	
* Assembling / Kitting	Blanking plug only — Blanking plug supplied with union nut -M

Connecting Parts



Union Nut
Type **FI-M**

Page 31

Spare Parts / Accessories



O-Ring
Type **O-RING**

Page 207

Series	Tube OD	PN	Dimensions		Weight (kg/lbs) ca. per 100 ²	Ordering Codes ³
	(mm/in) D1		(bar/psi)	(mm/in) L1 ¹		
L	6	500	17	14	0,55	FI-VD-06L/S-B-W3
	.24	7250	.67	.55	1.21	
	8	500	17	17	0,91	FI-VD-08L/S-B-W3
	.31	7250	.67	.67	2.02	
	10	500	20	19	1,55	FI-VD-10L/S-B-W3
	.39	7250	.79	.75	3.41	
	12	400	21	22	2,23	FI-VD-12L/S-B-W3
	.47	5800	.83	.87	4.91	
	15	400	20	27	3,60	FI-VD-15L-B-W3
	.59	5800	.79	1.06	7.92	
	18	400	21	32	4,88	FI-VD-18L-B-W3
	.71	5800	.83	1.26	10.74	
	22	250	23	36	7,70	FI-VD-22L-B-W3
	.87	3625	.91	1.42	16.94	
	28	250	23	41	12,00	FI-VD-28L-B-W3
	1.10	3625	.91	1.61	26.40	
	35	250	29	50	24,00	FI-VD-35L-B-W3
	1.38	3625	1.14	1.97	52.80	
	42	250	30	60	35,00	FI-VD-42L-B-W3
	1.65	3625	1.18	2.36	77.00	
S	6	800	17	17	0,55	FI-VD-06L/S-B-W3
	.24	11600	.67	.67	1.21	
	8	800	17	19	0,91	FI-VD-08L/S-B-W3
	.31	11600	.67	.75	20.01	
	10	800	20	22	1,55	FI-VD-10L/S-B-W3
	.39	11600	.79	.87	3.41	
	12	630	21	24	2,23	FI-VD-12L/S-B-W3
	.47	9135	.83	.94	4.91	
	14	630	23	27	3,30	FI-VD-14S-B-W3
	.55	9135	.91	1.06	7.26	
	16	630	24	30	4,30	FI-VD-16S-B-W3
	.63	9135	.94	1.18	9.46	
	20	400	28	36	8,10	FI-VD-20S-B-W3
	.79	5800	1.10	1.42	17.82	
	25	400	31	46	13,50	FI-VD-25S-B-W3
	.98	5800	1.22	1.81	29.70	
	30	400	34	50	21,20	FI-VD-30S-B-W3
	1.18	5800	1.34	1.97	46.64	
	38	400	38	60	36,90	FI-VD-38S-B-W3
	1.50	5800	1.50	2.36	81.18	

¹ Approximate dimension in assembled condition.

² Weight excluding union nut.

³ Standard scope of delivery: Blanking plug only.

Standard seal material is NBR (Buna-N®).



Blanking Plug with Sealing Edge Type FI-BUZ • Series L / S

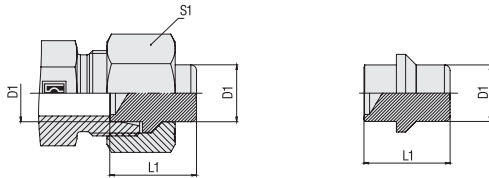

Series	Tube OD	PN	Dimensions		Weight (^{kg} / _{lbs}) ca. per 100 ²	Ordering Codes ³
	(^{mm} / _{in}) D1		(^{bar} / _{PSI})	(^{mm} / _{in}) L1 ¹		
L	6	500	19,5	14	0,55	FI-BUZ-06L/S-W3
	.24	7250	.77	.55	1.21	
	8	500	19,5	17	0,90	FI-BUZ-08L/S-W3
	.31	7250	.77	.67	1.98	
	10	500	21,5	19	1,48	FI-BUZ-10L/S-W3
	.39	7250	.85	.75	3.57	
	12	400	22	22	2,13	FI-BUZ-12L/S-W3
	.47	5800	.87	.87	4.69	
	15	400	22	27	3,20	FI-BUZ-15L-W3
	.59	5800	.87	1.06	7.04	
	18	400	24	32	5,00	FI-BUZ-18L-W3
	.71	5800	.94	1.26	11.00	
	22	250	26	36	7,90	FI-BUZ-22L-W3
	.87	3625	1.02	1.42	17.38	
	28	250	25,5	41	11,90	FI-BUZ-28L-W3
	1.10	3625	1.00	1.61	26.18	
	35	250	32	50	23,50	FI-BUZ-35L-W3
	1.38	3625	1.26	1.97	51.70	
	42	250	32,5	60	38,50	FI-BUZ-42L-W3
	1.65	3625	1.28	2.36	84.70	
S	6	800	19,5	17	0,55	FI-BUZ-06L/S-W3
	.24	11600	.77	.67	1.21	
	8	800	19,5	19	0,90	FI-BUZ-08L/S-W3
	.31	11600	.77	.75	1.98	
	10	800	21,5	22	1,48	FI-BUZ-10L/S-W3
	.39	11600	.85	.87	3.57	
	12	630	22	24	2,13	FI-BUZ-12L/S-W3
	.47	9135	.87	.94	4.69	
	14	630	23,5	27	3,12	FI-BUZ-14S-W3
	.55	9135	.93	1.06	6.86	
	16	630	25,5	30	4,27	FI-BUZ-16S-W3
	.63	9135	1.00	1.18	9.93	
	20	400	30,5	36	8,00	FI-BUZ-20S-W3
	.79	5800	1.20	1.42	17.60	
	25	400	32,5	46	17,90	FI-BUZ-25S-W3
	.98	5800	1.28	1.81	39.38	
	30	400	35,5	50	20,00	FI-BUZ-30S-W3
	1.18	5800	1.40	1.97	44.00	
	38	400	42	60	36,60	FI-BUZ-38S-W3
	1.50	5800	1.65	2.36	80.52	

Ordering Codes

FI-BUZ-10*L*-W3*-M

* Blanking Plug with Sealing Edge	FI-BUZ
* Outside Tube Diameter D1 (in mm)	-10
* Series	Light Series L Heavy Series S
* Material Code	Steel, zinc/nickel-plated -W3
Please contact STAUFF for alternative materials and surface finishings.	
* Assembling / Kitting	Blanking plug only — Blanking plug supplied with union nut -M

Connecting Parts

 Union Nut
Type FI-M

Page 31

¹ Approximate dimension in assembled condition.

² Weight excluding union nut.

³ Standard scope of delivery: Blanking plug only.



Blanking Plug for Tube Ends Type FI-VSK ▪ Series L / S

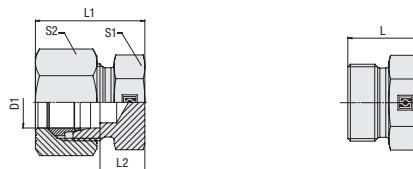

Ordering Codes

FI-VSK-10*L*-W3*-MS

- * Blanking Plug for Tube Ends **FI-VSK**
- * Outside Tube Diameter D1 (in mm) **-10**
- * Series **L**
Light Series **S**
Heavy Series
- * Material Code **-W3**
Steel, zinc/nickel-plated
- Please contact STAUFF for alternative materials and surface finishings.
- * Assembling / Kitting **—**
Blanking plug only
- Blanking plug supplied with cutting ring and union nut **-MS**
- Blanking plug supplied with soft-sealing cutting ring and union nut **-MSV**

Connecting Parts

-  Cutting Ring
Type **FI-DS** Page 26
-  Soft-Sealing Cutting Ring
Type **FI-WDDS** Page 27
-  Support Sleeve
Type **FI-VH** Page 28
-  STAUFF Form Ring
Type **FI-AR** Page 30
-  Union Nut
Type **FI-M** Page 31
-  37° Flared Tube Fitting Set
Type **FI-AB** Page 35

Series	Tube OD	PN	Dimensions					Weight (kg/lbs) ca. per 100 ²	Ordering Codes ³
	(mm/in) D1		(mm/in) L	(mm/in) L1 ¹	(mm/in) L2	(mm/in) S1	(mm/in) S2		
L	6	315	17	22	7	14	14	1,40	FI-VSK-06L-W3
	.24	4568	.55	.87	.28	.47	.55	3,08	
	8	315	17	23	8	17	17	1,93	FI-VSK-08L-W3
	.31	4568	.59	.91	.31	.55	.67	4,24	
	10	315	20	24	9	17	19	2,55	FI-VSK-10L-W3
	.39	4568	.63	.94	.35	.67	.75	5,61	
	12	315	21	25	10	19	22	3,44	FI-VSK-12L-W3
	.47	4568	.67	.98	.39	.75	.87	8,74	
	15	315	20	26	11	24	27	4,90	FI-VSK-15L-W3
	.59	4568	.71	1.02	.43	.94	1.06	10,78	
	18	315	21	28	11,5	27	32	6,80	FI-VSK-18L-W3
	.71	4568	.75	1.10	.45	1.06	1.26	14,96	
	22	160	23	30	13,5	32	36	10,70	FI-VSK-22L-W3
	.87	2320	.83	1.18	.53	1.26	1.42	23,54	
	28	160	23	31	14,5	41	41	15,20	FI-VSK-28L-W3
	1.10	2320	.87	1.22	.57	1.61	1.61	33,44	
	35	160	29	36	14,5	46	50	25,90	FI-VSK-35L-W3
	1.38	2320	.98	1.42	.57	1.81	1.97	56,98	
	42	160	30	39	16	55	60	35,30	FI-VSK-42L-W3
	1.65	2320	1.06	1.54	.63	2.17	2.36	77,66	
S	6	630	17	26	11	17	17	1,80	FI-VSK-06S-W3
	.24	9135	.71	1.02	.43	.55	.67	3,96	
	8	630	17	28	13	17	19	2,16	FI-VSK-08S-W3
	.31	9135	.79	1.10	.51	.67	.75	4,75	
	10	630	20	29	12,5	19	22	3,34	FI-VSK-10S-W3
	.39	9135	.79	1.14	.49	.75	.87	7,35	
	12	630	21	31	14,5	22	24	4,60	FI-VSK-12S-W3
	.47	9135	.87	1.22	.57	.87	.94	10,12	
	14	630	23	34	16	24	27	5,88	FI-VSK-14S-W3
	.55	9135	.94	1.34	.63	.94	1.06	12,94	
	16	400	24	34	15,5	27	30	7,54	FI-VSK-16S-W3
	.63	5800	.94	1.34	.61	1.06	1.18	16,59	
	20	400	28	39	17,5	32	36	12,50	FI-VSK-20S-W3
	.79	5800	1.10	1.54	.69	1.26	1.42	27,50	
	25	400	31	44	20	41	46	21,40	FI-VSK-25S-W3
	.98	5800	1.26	1.73	.79	1.61	1.81	47,08	
	30	400	34	47	20,5	46	50	30,40	FI-VSK-30S-W3
	1.18	5800	1.34	1.85	.81	1.81	1.97	76,20	
38	315	38	54	23	55	60	40,80	FI-VSK-38S-W3	
1.50	4568	1.54	2.13	.91	2.17	2.36	89,76		

¹ Approximate dimension in assembled condition.

² Weight excluding cutting ring and union nut.

³ Standard scope of delivery: Blanking plug only.

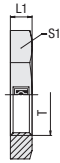

Hexagon Lock Nut
 Type FI-SKM • Series L / S

for Straight Bulkhead Fittings / Bulkhead Elbows

Series	Dimensions		Weight (^{kg} / _{lbs}) ca. per 100	Ordering Codes	
	(^{mm} / _{in}) Thread T	L1			S1
L	M 12 x 1,5	6	17	0,66	FI-SKM-06L-W3
		.24	.67	1.45	
	M 14 x 1,5	6	19	0,76	FI-SKM-08L/06S-W3
		.24	.75	1.67	
	M 16 x 1,5	6	22	1,04	FI-SKM-10L/08S-W3
		.24	.87	2.29	
	M 18 x 1,5	6	24	1,17	FI-SKM-12L/10S-W3
		.24	.94	2.62	
	M 22 x 1,5	7	30	2,25	FI-SKM-15L/14S-W3
		.28	1.18	4.95	
	M 26 x 1,5	8	36	3,75	FI-SKM-18L-W3
		.31	1.42	8.25	
	M 30 x 2	8	41	4,79	FI-SKM-22L/20S-W3
		.31	1.61	10.53	
M 36 x 2	9	46	5,90	FI-SKM-28L/25S-W3	
	.35	1.81	12.98		
M 45 x 2	9	55	7,60	FI-SKM-35L-W3	
	.35	2.17	16.72		
M 52 x 2	10	65	12,20	FI-SKM-42L/38S-W3	
	.39	2.56	26.84		
S	M 14 x 1,5	6	19	0,76	FI-SKM-08L/06S-W3
		.24	.75	1.67	
	M 16 x 1,5	6	22	1,04	FI-SKM-10L/08S-W3
		.24	.87	2.29	
	M 18 x 1,5	6	24	1,17	FI-SKM-12L/10S-W3
		.24	.94	2.57	
	M 20 x 1,5	6	27	1,54	FI-SKM-12S-W3
		.24	1.06	3.39	
	M 22 x 1,5	7	30	2,25	FI-SKM-15L/14S-W3
		.28	1.18	4.95	
	M 24 x 1,5	7	32	2,40	FI-SKM-16S-W3
		.28	1.26	5.28	
	M 30 x 2	8	41	4,79	FI-SKM-22L/20S-W3
		.31	1.61	10.54	
M 36 x 2	9	46	5,90	FI-SKM-28L/25S-W3	
	.35	1.81	12.98		
M 42 x 2	9	50	5,70	FI-SKM-30S-W3	
	.35	1.97	12.54		
M 52 x 2	10	65	12,20	FI-SKM-42L/38S-W3	
	.39	2.56	26.84		

Ordering Codes

***FI-SKM*-06*L*-W3**

* Hexagon Lock Nut for Bulkhead Fittings	FI-SKM
* Outside Tube Diameter D1 (in mm)	-06
* Series	Light Series L Heavy Series S
* Material Code	Steel, zinc/nickel-plated -W3

Please contact STAUFF for alternative materials and surface finishings.



Profile Sealing Ring for Male Studs Type WDG

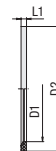

Whitworth Parallel Pipe Thread (BSPP)

Male stud acc. to ISO 1179-2 (Type E) / Port according to ISO 1179-1

Dimensions (^{mm} / _{in}) for Thread	D1	D2	L1	Ordering Codes	
				NBR (Buna-N®)	FKM (Viton®)
G 1/8	8,4	11,9	1	WDG-8.4x11.9x1-B90	WDG-8.4x11.9x1-V90
	.33	.47	.04		
G 1/4	11,6	16,5	1,5	WDG-11.6x16.5x1.5-B90	WDG-11.6x16.5x1.5-V90
	.46	.65	.06		
G 3/8	14,7	18,9	1,5	WDG-14.7x18.9x1.5-B90	WDG-14.7x18.9x1.5-V90
	.58	.74	.06		
G 1/2	18,5	23,9	1,5	WDG-18.5x23.9x1.5-B90	WDG-18.5x23.9x1.5-V80
	.73	.94	.06		
G 3/4	23,9	29,2	1,5	WDG-23.9x29.2x1.5-B90	WDG-23.9x29.2x1.5-V80
	.94	1.15	.06		
G 1	29,7	35,7	2	WDG-29.7x35.7x2-B90	WDG-29.7x35.7x2-V80
	1.17	1.41	.08		
G 1 1/4	38,8	45,8	2	WDG-38.8x45.8x2-B90	WDG-38.8x45.8x2-V80
	1.53	1.80	.08		
G 1 1/2	44,7	50,7	2	WDG-44.7x50.7x2-B90	WDG-44.7x50.7x2-V80
	1.76	2.00	.08		

Metric Parallel Thread

Male stud according to ISO 9974-2 (Type E) / Port according to ISO 9974-1

Dimensions (^{mm} / _{in}) for Thread	D1	D2	L1	Ordering Codes	
				NBR (Buna-N®)	FKM (Viton®)
M 8 x 1	6,5	9,9	1	WDG-6.5x9.9x1-B90	WDG-6.5x9.9x1-V90
	.26	.39	.04		
M 10 x 1	8,4	11,9	1	WDG-8.4x11.9x1-B90	WDG-8.4x11.9x1-V90
	.33	.47	.04		
M 12 x 1,5	9,8	14,5	1,5	WDG-9.8x14.5x1.5-B90	WDG-9.8x14.5x1.5-V90
	.39	.57	.06		
M 14 x 1,5	11,6	16,5	1,5	WDG-11.6x16.5x1.5-B90	WDG-11.6x16.5x1.5-V90
	.46	.65	.06		
M 16 x 1,5	13,8	18,9	1,5	WDG-13.8x18.9x1.5-B80	WDG-13.8x18.9x1.5-V80
	.54	.74	.06		
M 18 x 1,5	15,7	20,9	1,5	WDG-15.7x20.9x1.5-B90	WDG-15.7x20.9x1.5-V80
	.62	.82	.06		
M 20 x 1,5	17,8	22,9	1,5	WDG-17.8x22.9x1.5-B90	WDG-17.8x22.9x1.5-V90
	.70	.90	.06		
M 22 x 1,5	19,6	24,3	1,5	WDG-19.6x24.3x1.5-B90	WDG-19.6x24.3x1.5-V80
	.77	.96	.06		
M 26 x 1,5	23,9	29,2	1,5	WDG-23.9x29.2x1.5-B90	WDG-23.9x29.2x1.5-V80
	.94	1.15	.06		
M 27 x 2	23,9	29,2	1,5	WDG-23.9x29.2x1.5-B90	WDG-23.9x29.2x1.5-V80
	.94	1.15	.06		
M 33 x 2	29,7	35,7	2	WDG-29.7x35.7x2-B90	WDG-29.7x35.7x2-V80
	1.17	1.41	.08		
M 42 x 2	38,8	45,8	2	WDG-38.8x45.8x2-B90	WDG-38.8x45.8x2-V80
	1.53	1.80	.08		
M 48 x 2	44,7	50,7	2	WDG-44.7x50.7x2-B90	WDG-44.7x50.7x2-V80
	1.76	2.00	.08		



O-Ring for Male Studs
 Type O-RING

Male stud according to ISO 6149-2/-3 / Port according to ISO 6149-1

Metric Parallel Thread

Dimensions (^{mm} / _{in}) for Thread	Ordering Codes	
	NBR (Buna-N®)	FKM (Viton®)
M 8 x 1	O-RING-6.07x1.63-B90	O-RING-6.07x1.63-V90
M 10 x 1	O-RING-8.1x1.6-B90	O-RING-8.1x1.6-V90
M 12 x 1,5	O-RING-9.3x2.2-B90	O-RING-9.3x2.2-V90
M14 x 1,5	O-RING-11.3x2.2-B90	O-RING-11.3x2.2-V90
M16 x 1,5	O-RING-13.3x2.2-B90	O-RING-13.3x2.2-V90
M18 x 1,5	O-RING-15.3x2.2-B90	O-RING-15.3x2.2-V90
M22 x 1,5	O-RING-19.3x2.2-B90	O-RING-19.3x2.2-V90
M26 x 1,5	O-RING-23.3x2.4-B90	O-RING-23.3x2.4-V90
M27 x 2	O-RING-23.6x2.9-B90	O-RING-23.6x2.9-V90
M30 x 2	O-RING-26.62 x2.95-B90	O-RING-26.62 x2.95-V90
M33 x 2	O-RING-29.6x2.9-B90	O-RING-29.6x2.9-V90
M42 x 2	O-RING-38.6x2.9-B90	O-RING-38.6x2.9-V90
M48 x 2	O-RING-44.6x2.9-B90	O-RING-44.6x2.9-V90

Male stud according to ISO 11926-2/-3 / Port according to ISO 11926-1

UN / UNF Thread

Dimensions (^{mm} / _{in}) for Thread	Ordering Codes	
	NBR (Buna-N®)	FKM (Viton®)
7/16-20 UNF	O-RING-8.92x1.83-B90	O-RING-8.92x1.83-V90
1/2-20 UNF	O-RING-10.52x1.83-B90	O-RING-10.52x1.83-V90
9/16-18 UNF	O-RING-11.89x1.98-B90	O-RING-11.89x1.98-V90
3/4-16 UNF	O-RING-16.36x2.2-B90	O-RING-16.36x2.2-V90
7/8-14 UNF	O-RING-19.18x2.46-B90	O-RING-19.18x2.46-V 90
1 1/16-12 UN	O-RING-23.47x2.95-B90	O-RING-23.47x2.95-V80
1 3/16-12 UN	O-RING-26.62 x2.95-B90	O-RING-26.62 x 2.95-V90
1 5/16-12 UN	O-RING-29.74x2.95-90B	O-RING-29.74x2.95-V90
1 5/8-12 UN	O-RING-37.47x3-B90	O-RING-37.47x3-V90
1 7/8-12 UN	O-RING-43.69x3-B90	O-RING-43.69x3-V90

Whitworth Parallel Pipe Thread (BSPP)

Dimensions (^{mm} / _{in}) for Thread	Ordering Codes	
	NBR (Buna-N®)	FKM (Viton®)
G 1/8	O-RING-7,97x1,88-B90	O-RING-7,97x1,88-V90
G 1/4	O-RING-10,77x2,62-B90	O-RING-10,77x2,62-V90
G 3/8	O-RING-13,94x2,62-B90	O-RING-13,94x2,62-V90
G 1/2	O-RING-17,86x2,62-B90	O-RING-17,86x2,62-V90
G 3/4	O-RING-23,47x2,62-B90	O-RING-23,47x2,62-V90
G 1	O-RING-29,74x3,53-B90	O-RING-29,74x3,53-V90
G 1 1/4	O-RING-37,69x3,53-B90	O-RING-37,69x3,53-V90
G 1 1/2	O-RING-44,04x3,53-B90	O-RING-44,04x3,53-V90



O-Ring for 24°/37° Flared Cone Adaptors

Type O-RING



24° Taper of the Flared Cone Adaptor

Series	Tube OD (mm/in)	Ordering Codes	
		NBR (Buna-N®)	FKM (Viton®)
L	6	0-RING-4.5x1.5-B90	0-RING-4.5x1.5-V90
	.24		
	8	0-RING-6.5x1.5-B90	0-RING-6.5x1.5-V90
	.31		
	10	0-RING-8.5x1.5-B90	0-RING-8.5x1.5-V90
	.39		
	12	0-RING-10x1.5-B90	0-RING-10x1.5-V90
	.47		
	15	0-RING-12.5x2-B90	0-RING-12.5x2-V90
	.59		
	18	0-RING-16x2-B90	0-RING-16x2-V90
	.71		
	22	0-RING-20x2-B90	0-RING-20x2-V90
	.87		
	28	0-RING-26x2-B90	0-RING-26x2-V90
	1.10		
	35	0-RING-32x2.5-B90	0-RING-32x2.5-V90
1.38			
42	0-RING-38x2.5-B90	0-RING-38x2.5-V90	
1.65			
S	6	0-RING-4.5x1.5-B90	0-RING-4.5x1.5-V90
	.24		
	8	0-RING-6.5x1.5-B90	0-RING-6.5x1.5-V90
	.31		
	10	0-RING-8.5x1.5-B90	0-RING-8.5x1.5-V90
	.39		
	12	0-RING-10x1.5-B90	0-RING-10x1.5-V90
	.47		
	14	0-RING-12x2-B90	0-RING-12x2-V90
	.55		
	16	0-RING-14x2-B90	0-RING-14x2-V90
	.63		
	20	0-RING-17.3x2.4-B90	0-RING-17.3x2.4-V90
	.79		
	25	0-RING-22.3x2.4-B90	0-RING-22.3x2.4-V90
	.98		
	30	0-RING-27.3x2.4-B90	0-RING-27.3x2.4-V90
1.18			
38	0-RING-35x2.5-B90	0-RING-35x2.5-V90	
1.50			



O-Ring for 24°/37° Flared Cone Adaptors Type O-RING



37° Taper of the Flared Cone Adaptor

Series	Tube OD (mm/in)	Ordering Codes	
		NBR (Buna-N®)	FKM (Viton®)
L	6	O-RING-4.4x0.8-B90	O-RING-4.4x0.8-V90
	.24		
	8	O-RING-6x0.8-B90	O-RING-6x0.8-V90
	.31		
	10	O-RING-7.5x0.8-B90	O-RING-7.5x0.8-V90
	.39		
	12	O-RING-9.5x0.8-B90	O-RING-9.5x0.8-V90
	.47		
	15	O-RING-12.5x0.8-B90	O-RING-12.5x0.8-V90
	.59		
	18	O-RING-15x1-B90	O-RING-15x1-V90
	.71		
	22	O-RING-18x1-B90	O-RING-18x1-V90
	.87		
	28	O-RING-23x1-B90	O-RING-23x1-V90
	1.10		
	35	O-RING-30x1-B90	O-RING-30x1-V90
1.38			
42	O-RING-37x1-B90	O-RING-37x1-V90	
1.65			
S	6	O-RING-4.4x0.8-B90	O-RING-4.4x0.8-V90
	.24		
	8	O-RING-6x0.8-B90	O-RING-6x0.8-V90
	.31		
	10	O-RING-7.5x0.8-B90	O-RING-7.5x0.8-V90
	.39		
	12	O-RING-9.5x0.8-B90	O-RING-9.5x0.8-V90
	.47		
	14	O-RING-11x1-B90	O-RING-11x1-V90
	.55		
	16	O-RING-12.5x1-B90	O-RING-12.5x1-V90
	.63		
	20	O-RING-16x1-B90	O-RING-16x1-V90
	.79		
	25	O-RING-20x1-B90	O-RING-20x1-V90
	.98		
	30	O-RING-25x1-B90	O-RING-25x1-V90
1.18			
38	O-RING-32x1.8-B90	O-RING-32x1.8-V90	
1.50			



O-Ring for for DKO Taper Fittings / 24° Weld Cones Type O-RING



Series	Tube OD (mm/in)	Ordering Codes	
		NBR (Buna-N®)	FKM (Viton®)
L	6	0-RING-4.5x1.5-B90	0-RING-4.5x1.5-V90
	.24		
	8	0-RING-6.5x1.5-B90	0-RING-6.5x1.5-V90
	.31		
	10	0-RING-8.5x1.5-B90	0-RING-8.5x1.5-V90
	.39		
	12	0-RING-10x1.5-B90	0-RING-10x1.5-V90
	.47		
	15	0-RING-12.5x2-B90	0-RING-12.5x2-V90
	.59		
	18	0-RING-16x2-B90	0-RING-16x2-V90
	.71		
	22	0-RING-20x2-B90	0-RING-20x2-V90
	.87		
	28	0-RING-26x2-B90	0-RING-26x2-V90
	1.10		
35	0-RING-32x2.5-B90	0-RING-32x2.5-V90	
1.38			
42	0-RING-38x2.5-B90	0-RING-38x2.5-V90	
1.65			
S	6	0-RING-4.5x1.5-B90	0-RING-4.5x1.5-V90
	.24		
	8	0-RING-6.5x1.5-B90	0-RING-6.5x1.5-V90
	.31		
	10	0-RING-8.5x1.5-B90	0-RING-8.5x1.5-V90
	.39		
	12	0-RING-10x1.5-B90	0-RING-10x1.5-V90
	.47		
	14	0-RING-12x2-B90	0-RING-12x2-V90
	.55		
	16	0-RING-14x2-B90	0-RING-14x2-V90
	.63		
	20	0-RING-17.3x2.4-B90	0-RING-17.3x2.4-V90
	.79		
	25	0-RING-22.3x2.4-B90	0-RING-22.3x2.4-V90
	.98		
30	0-RING-27.3x2.4-B90	0-RING-27.3x2.4-V90	
1.18			
38	0-RING-35x2.5-B90	0-RING-35x2.5-V90	
1.50			



O-Ring for Banjo Bolts of Banjo Fittings Type O-RING



Dimensions (^{mm} / _{in})		Ordering Codes	
for Thread	for Tube Size / Series	NBR (Buna-N®)	FKM (Viton®)
G 1/8	4LL / 6LL / 8LL / 6L	O-RING-8.5x1.5-B90	O-RING-8.5x1.5-V90
G 1/4	8L / 10L / 12L / 6S / 8S	O-RING-11x2-B90	O-RING-11x2-V90
G 3/8	12L / 10S / 12S	O-RING-14.5x2-B90	O-RING-14.5x2-V90
G 1/2	15L / 18L / 14S / 16S	O-RING-19.5x2-B90	O-RING-19.5x2-V90
G 3/4	22L / 20S	O-RING-26x1.5-B90	O-RING-26x1.5-V90
G 1	28L / 25S	O-RING-31x2-B90	O-RING-31x2-V90
G 1 1/4	35L / 30S	O-RING-40x2-B90	O-RING-40x2-V90
G 1 1/2	42L / 38S	O-RING-46x2-B90	O-RING-46x2-V90
M 8 x 1	4LL	O-RING-6.5x1.5-B90	O-RING-6.5x1.5-V90
M 10 x 1	6LL / 8LL / 6L	O-RING-8.5x1.5-B90	O-RING-8.5x1.5-V90
M 12 x 1,5	8L / 6S	O-RING-11x2-B90	O-RING-11x2-V90
M 14 x 1,5	10L / 8S / 12L	O-RING-11x2-B90	O-RING-11x2-V90
M 16 x 1,5	12L / 10S	O-RING-14.5x2-B90	O-RING-14.5x2-V90
M 18 x 1,5	12L / 10S	O-RING-14.5x2-B90	O-RING-14.5x2-V90
M 18 x 1,5	15L / 12S	O-RING-16.5x2-B90	O-RING-16.5x2-V90
M 20 x 1,5	14S	O-RING-19.5x2-B90	O-RING-19.5x2-V90
M 22 x 1,5	18L / 16S	O-RING-19.5x2-B90	O-RING-19.5x2-V90
M 26 x 1,5	22L	O-RING-26x1.5-B90	O-RING-26x1.5-V90
M 27 x 2	20S	O-RING-26x1.5-B90	O-RING-26x1.5-V90
M 33 x 2	28L / 25S	O-RING-31x2-B90	O-RING-31x2-V90
M 42 x 2	35L / 30S	O-RING-40x2-B90	O-RING-40x2-V90
M 48 x 2	42L / 38S	O-RING-46x2-B90	O-RING-46x2-V90



External Metallic Sealing Ring for Male Studs of Banjo Fittings Type FI-DKR



Dimensions (^{mm} / _{in}) for Thread					Ordering Codes
		D1	D2	L1	
M 8 x 1		8,05	10,8	4	FI-DKR-M8x1-W3-WOB
		.32	.43	.16	
M 10 x 1	G 1/8	10,1	13	4	FI-DKR-M10x1-R1/8-W3-WOB
		.40	.51	.16	
M 12 x 1,5		12,2	17,8	4	FI-DKR-M12x1.5-W3-WOB
		.48	.70	.16	
	G 1/4	13,2	17,7	4	FI-DKR-R1/4-W3-WOB
		.52	.70	.16	
M 14 x 1,5		14,1	17,7	4,4	FI-DKR-M14x1.5-W3-WOB
		.56	.70	.17	
M 16 x 1,5		16,1	21,5	5	FI-DKR-M16x1.5-W3-WOB
		.63	.85	.20	
	G 3/8	16,7	22	5	FI-DKR-R3/8-W3-WOB
		.66	.87	.20	
M 18 x 1,5		18,1	23	5	FI-DKR-M18x1.5-W3-WOB
		.71	.91	.20	
M 20 x 1,5	G 1/2	21	26	7	FI-DKR-M20x1.5-R1/2-W3-WOB
		.83	1.02	.28	
M 22 x 1,5		22,1	27	7	FI-DKR-M22x1.5-W3-WOB
		.87	1.06	.28	
M 26 x 1,5		26,1	31,5	5,5	FI-DKR-M26x1.5-W3-WOB
		1.03	1.24	.22	
M 27 x 2	G 3/4	27,1	32	5,5	FI-DKR-M27x2-R3/4-W3-WOB
		1.07	1.26	.22	
M 33 x 2		33,3	39	5,5	FI-DKR-M33x2-R1-W3-WOB
		1.31	1.54	.22	
M 42 x 2	G 1 1/4	42,1	49	5,5	FI-DKR-M42x2-R1-1/4-W3-WOB
		1.66	1.93	.22	
M 48 x 2	G 1 1/2	48,1	55	5,5	FI-DKR-M48x2-R1-1/2-W3-WOB
		1.89	2.17	.22	



Retaining Ring with Captive Seal for Male Studs of Banjo Fittings Type FI-DIR

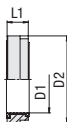

Dimensions (^{mm} / _{in}) for Thread		D1	D2	L1	Ordering Codes
M 10 x 1	G 1/8	10,2	14,9	4	FI-DIR-M10x1-R1/8-B-W3
		.40	.59	.16	
M 12 x 1,5		12,2	17,8	4	FI-DIR-M12x1.5-B-W3
		.48	.70	.16	
	G 1/4	13,3	18,8	4	FI-DIR-R1/4-B-W3
		.52	.74	.16	
M 14 x 1,5		14,1	19,9	4	FI-DIR-M14x1.5-B-W3
		.56	.78	.16	
M 16 x 1,5	G 3/8	16,8	22,8	4,4	FI-DIR-M16x1.5-R3/8-B-W3
		.66	.90	.17	
M 18 x 1,5		18,1	25,8	5	FI-DIR-M18x1.5-B-W3
		.71	1.02	.20	
M 18 x 1,5 (only 12L)		18,1	23,8	5	FI-DIR-12LM18x1.5-B-W3
		.71	.94	.20	
	G 1/2 (only 15L / 14S)	21	28,8	5	FI-DIR-15L/14S-R1/2-B-W3
		.83	1.13	.20	
	G 1/2 (only 18L / 16S)	21	28,8	7	FI-DIR-18L/16S-R1/2-B-W3
		.83	1.13	.28	
M 22 x 1,5		22,1	28,8	7	FI-DIR-M22x1.5-B-W3
		.87	1.13	.28	
M 26 x 1,5		26,1	34,8	5,5	FI-DIR-M26x1.5-B-W3
		1.03	1.37	.22	
M 27 x 2	G 3/4	27	34,8	5,5	FI-DIR-M27x2-R3/4-B-W3
		1.06	1.37	.22	
M 33 x 2	G 1	33,4	41,8	5,5	FI-DIR-M33x2-R1-B-W3
		1.31	1.65	.22	
M 42 x 2	G 1 1/4	42,1	51,8	5,5	FI-DIR-M42x2-R1-1/4-B-W3
		1.66	2.04	.22	
M 48 x 2	G 1 1/2	47,8	57,9	5,5	FI-DIR-M48x2-R1-1/2-B-W3
		1.88	2.28	.22	



Internal Metallic Sealing Ring for Female Studs of Gauge Fittings Type FI-DKI



Dimensions (^{mm} / _{in}) for Thread				Ordering Codes
	D1	D2	L1	
G 1/4	6	11,3	4,5	FI-DKI-R1/4-W3-W0B
	.24	.44	.18	
G 1/2	12	18,5	5	FI-DKI-R1/2-W3-W0B
	.47	.73	.20	





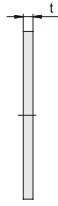
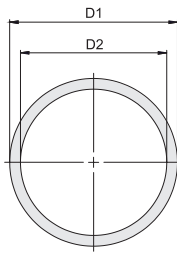

















Retaining Ring (Small) for Male Studs of Fittings with Lock Nut Type FI-KR



Dimensions (^{mm} / _{in}) for Thread	D1	D2	t	Ordering Codes
G 1/8	14,8 .58	11,8 .46	1,4 .06	FI-KR-R1/8-W3-WOB
G 1/4	19,8 .78	16,15 .64	1,9 .07	FI-KR-R1/4-W3-WOB
G 3/8	22,8 .90	19,4 .76	1,9 .07	FI-KR-R3/8-W3-WOB
G 1/2	27,8 1.09	23,2 .91	1,9 .07	FI-KR-R1/2-W3-WOB
G 3/4	32,8 1.29	28,6 1.13	1,9 .07	FI-KR-R3/4-W3-WOB
G 1	40,8 1.61	36,6 1.44	2,6 .10	FI-KR-R1-W3-WOB
G 1 1/4	50,8 2.00	44,9 1.77	2,6 .10	FI-KR-R1-1/4-W3-WOB
G 1 1/2	55,8 2.20	50,9 2.00	2,6 .10	FI-KR-R1-1/2-W3-WOB
M 10 x 1	14,8 .58	11,4 .45	1,1 .04	FI-KR-M10x1-W3-WOB
M 12 x 1,5	17,8 .70	13,9 .55	1,7 .07	FI-KR-M12x1.5-W3-WOB
M 14 x 1,5	19,8 .78	15,9 .63	1,7 .07	FI-KR-M14x1.5--W3-WOB
M 16 x 1,5	22,8 .90	17,9 .70	1,7 .07	FI-KR-M16x1.5-W3-WOB
M 18 x 1,5	24,8 .98	19,9 .78	1,7 .07	FI-KR-M18x1.5-W3-WOB
M 22 x 1,5	27,8 1.09	23,9 .94	1,7 .07	FI-KR-M22x1.5-W3-WOB
M 27 x 2	32,8 1.29	29,6 1.17	2,2 .09	FI-KR-M27x2-W3-WOB
M 33 x 2	40,8 1.61	35,6 1.40	2,2 .09	FI-KR-M33x2-W3-WOB
M 42 x 2	50,8 2.00	44,6 1.76	2,2 .09	FI-KR-M42x2-W3-WOB
M 48 x 2	55,8 2.20	50,6 1.99	2,2 .09	FI-KR-M48x2-W3-WOB
7/16-20 UNF	17 .67	13 .51	1,3 .05	FI-KR-7/16U-W3-WOB
9/16-18 UNF	21 .83	16,1 .63	1,4 .06	FI-KR-9/16U-W3-WOB
3/4-16 UNF	26,5 1.04	21 .83	1,6 .06	FI-KR-3/4U-W3-WOB
7/8-14 UNF	30 1.18	24,3 .96	1,8 .07	FI-KR-7/8U-W3-WOB
1 1/16-12 UN	37,5 1.48	29,6 1.17	2,2 .09	FI-KR-1-1/16U-W3-WOB
1 5/16-12 UN	45 1.77	35,8 1.41	2,2 .09	FI-KR-1-5/16U-W3-WOB
1 5/8-12 UN	56,5 2.22	43,7 1.72	2,2 .09	FI-KR-1-5/8U-W3-WOB
1 7/8-12 UN	64 2.52	49,9 1.96	2,2 .09	FI-KR-1-7/8U-W3-WOB





	Final Assembly Stud for the Manual Cutting Ring Assembly FI-FK	218		STAUFF Form Tube Forming Machine SFO-F	234
	Pre-Assembly Stud for the Manual Cutting Ring Assembly FI-VK	219		Tube Shapers FI-FST	236
	Cutting Ring Pre-Assembly and Final Assembly Machine SPR-PRC-POC	220		Internal Tube Supports FI-ID	236
	Cutting Ring Assembly Stud for Machine-Assisted Assembly FI-MFK	222		Clamping Jaws FI-FB	237
	Support Plate for Machine-Assisted Assembly FI-GP	223		STAUFF Clean Pipe, Tube and Hose Cleaning System SC	238
	Cutting Ring Pre-Assembly and 37° Flaring Machine with Automatic / Manual Pressure Setting SPR-PRC-MA	224		Thread Identification Board FI-TIB	240
	Tooling Head for Cutting Ring Assembly (Automatic Pressure Setting) SPR-PRC-TH-C-A	226			
	Tooling Head for Cutting Ring Assembly (Manual Pressure Setting) SPR-PRC-TH-C-M	226			
	Tooling Head for 37° Flaring (Manual Pressure Setting) SPR-PRC-TH-F-M	226			
	External Hand Control Switch SPR-PRC-HS	226			
	Assembly Tool Magazine SPR-TM	226			
	Cutting Ring Assembly Stud for Machine-Assisted Assembly FI-MVK-PRC	227			
	Support Plate for Machine-Assisted Assembly FI-GP-PRC	228			
	Clamping Jaws for 37° Flaring FI-KB-PRC	229			
	Portable Cutting Ring Assembly Machine with Manual Pressure Setting (Set) SPR-PRC-H-SET	230			
	Cutting Ring Assembly Stud for Machine-Assisted Assembly FI-MVK-PRC-H-M	232			



Final Assembly Stud for the Manual Cutting Ring Assembly Type FI-FK • Series LL / L / S

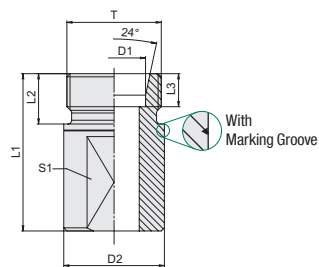

Series	Tube OD (mm/in)	Dimensions (mm/in)	Dimensions					Weight (kg/lbs) ca. per 100	Ordering Codes
			D1	Thread T	D2	L1	L2		
LL	4	M 8 x 1	14	40	8	4	11	3,74	FI-FK-04LL-HR
	.16		.55	1.57	.31	.16	.43	8.23	
	6	M 10 x 1	14	40	8	5,5	11	3,81	FI-FK-06LL-HR
	.24		.55	1.57	.31	.22	.43	8.39	
8	M 12 x 1	14	41	9	5,5	11	4,00	FI-FK-08LL-HR	
.31		.55	1.61	.35	.22	.43	8.81		
L	6	M 12 x 1,5	14	43	10	7	11	4,21	FI-FK-06L-HR
	.24		.55	1.69	.39	.28	.43	9.26	
	8	M 14 x 1,5	15	43	10	7	12	4,96	FI-FK-08L-HR
	.31		.59	1.69	.39	.28	.47	10.90	
	10	M 16 x 1,5	17	44	11	7	14	6,57	FI-FK-10L-HR
	.39		.67	1.73	.43	.28	.55	14.46	
	12	M 18 x 1,5	20	44	11	7	17	9,06	FI-FK-12L-HR
	.47		.79	1.73	.43	.28	.67	19.92	
	15	M 22 x 1,5	23	45	12	7	19	12,34	FI-FK-15L-HR
	.59		.91	1.77	.47	.28	.75	27.14	
	18	M 26 x 1,5	29	46	12	7,5	24	19,62	FI-FK-18L-HR
	.71		1.14	1.81	.47	.30	.94	43.16	
	22	M 30 x 2	32	48	14	7,5	27	25,11	FI-FK-22L-HR
	.87		1.26	1.89	.55	.30	1.06	55.23	
	28	M 36 x 2	38	48	14	7,5	32	35,07	FI-FK-28L-HR
	1.10		1.50	1.89	.55	.30	1.26	77.15	
35	M 45 x 2	48	60	16	10,5	41	69,87	FI-FK-35L-HR	
1.38		1.89	2.36	.63	.41	1.61	153.71		
42	M 52 x 2	54	60	16	11	46	87,41	FI-FK-42L-HR	
1.65		2.13	2.36	.63	.43	1.81	192.31		
S	6	M 14 x 1,5	15	45	12	7	12	5,34	FI-FK-06S-HR
	.24		.59	1.77	.47	.28	.47	11.75	
	8	M 16 x 1,5	17	45	12	7	14	6,92	FI-FK-08S-HR
	.31		.67	1.77	.47	.28	.55	15.23	
	10	M 18 x 1,5	20	45	12	7,5	17	9,44	FI-FK-10S-HR
	.39		.79	1.77	.47	.30	.67	20.78	
	12	M 20 x 1,5	22	45	12	7,5	17	10,87	FI-FK-12S-HR
	.47		.87	1.77	.47	.30	.67	23.92	
	14	M 22 x 1,5	24	47	14	8	19	13,59	FI-FK-14S-HR
	.55		.94	1.85	.55	.31	.75	29.90	
	16	M 24 x 1,5	27	48	14	8,5	22	17,49	FI-FK-16S-HR
	.63		1.06	1.89	.55	.33	.87	38.48	
	20	M 30 x 2	32	50	16	10,5	27	25,83	FI-FK-20S-HR
	.79		1.26	1.97	.63	.41	1.06	56.82	
25	M 36 x 2	38	62	18	12	32	46,15	FI-FK-25S-HR	
.98		1.50	2.44	.71	.47	1.26	101.54		
30	M 42 x 2	44	64	20	13,5	36	62,34	FI-FK-30S-HR	
1.18		1.73	2.52	.79	.53	1.42	137.15		
38	M 52 x 2	54	66	22	16	46	95,92	FI-FK-38S-HR	
1.50		2.13	2.60	.87	.63	1.81	211.03		

Materials / surface finishings: HR Steel, uncoated, hardened

P

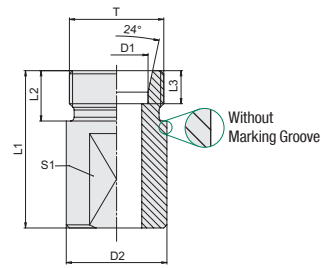

**Pre-Assembly Stud for the Manual Cutting Ring Assembly
Type FI-VK - Series LL / L / S**

Series	Tube OD		Dimensions					Weight (%)/lbs ca. per 100	Ordering Codes		
	(mm/in)	(mm/in)	D1	Thread T	D2	L1	L2			L3	S1
LL	4	M 8 x 1	.16		14	25	8	4,3	11	2,11	FI-VK-04LL-HR
	.55			.55	.98	.31	.17	.43	4,64		
	6	M 10 x 1	.24		14	25	8	5,8	11	2,18	FI-VK-06LL-HR
.55			.55	.98	.31	.23	.43	4,79			
LL	8	M 12 x 1	.31		14	26	9	5,8	11	2,36	FI-VK-08LL-HR
	.55			.55	1,02	.35	.23	.43	5,20		
L	6	M 12 x 1,5	.24		14	28	10	7,3	11	2,57	FI-VK-06L-HR
	.55			.55	1,10	.39	.29	.43	5,66		
	8	M 14 x 1,5	.31		15	28	10	7,3	12	3,05	FI-VK-08L-HR
	.59			.59	1,10	.39	.29	.47	6,71		
	10	M 16 x 1,5	.39		17	29	11	7,3	14	4,07	FI-VK-10L-HR
	.67			.67	1,14	.43	.29	.55	8,96		
	12	M 18 x 1,5	.47		20	29	11	7,3	17	5,53	FI-VK-12L-HR
	.79			.79	1,14	.43	.29	.67	12,16		
	15	M 22 x 1,5	.59		23	30	12	7,3	19	7,75	FI-VK-15L-HR
	.91			.91	1,18	.47	.29	.75	17,04		
	18	M 26 x 1,5	.71		29	31	12	7,8	24	12,31	FI-VK-18L-HR
	.94			.94	1,22	.47	.31	.94	27,08		
	22	M 30 x 2	.87		32	33	14	7,8	27	16,08	FI-VK-22L-HR
	1,06			1,06	1,30	.55	.31	1,06	35,38		
	28	M 36 x 2	1,10		38	33	14	7,8	32	22,34	FI-VK-28L-HR
	1,26			1,26	1,30	.55	.31	1,26	49,15		
	35	M 45 x 2	1,38		48	45	16	10,8	41	49,40	FI-VK-35L-HR
	1,61			1,61	1,77	.63	.43	1,61	108,67		
42	M 52 x 2	1,65		54	45	16	11,3	46	61,50	FI-VK-42L-HR	
1,81			1,81	1,77	.63	.44	1,81	135,31			
S	6	M 14 x 1,5	.24		15	30	12	7,3	12	3,43	FI-VK-06S-HR
	.59			.59	1,18	.47	.29	.47	7,55		
	8	M 16 x 1,5	.31		17	30	12	7,3	14	4,43	FI-VK-08S-HR
	.67			.67	1,18	.47	.29	.55	9,75		
	10	M 18 x 1,5	.39		20	30	12	7,8	17	5,92	FI-VK-10S-HR
	.79			.79	1,18	.47	.31	.67	13,03		
	12	M 20 x 1,5	.47		22	30	12	7,8	17	6,87	FI-VK-12S-HR
	.87			.87	1,18	.47	.31	.67	15,11		
	14	M 22 x 1,5	.55		24	32	14	8,3	19	8,74	FI-VK-14S-HR
	.94			.94	1,26	.55	.33	.75	19,23		
	16	M 24 x 1,5	.63		27	33	14	8,8	22	11,23	FI-VK-16S-HR
	1,06			1,06	1,30	.55	.35	.87	24,70		
	20	M 30 x 2	.79		32	35	16	10,8	27	16,83	FI-VK-20S-HR
	1,06			1,06	1,38	.63	.43	1,06	37,02		
	25	M 36 x 2	.98		38	47	18	12,3	32	33,47	FI-VK-25S-HR
1,26			1,26	1,85	.71	.48	1,26	73,63			
30	M 42 x 2	1,18		44	49	20	13,8	36	45,62	FI-VK-30S-HR	
1,42			1,42	1,93	.79	.54	1,42	100,37			
38	M 52 x 2	1,50		54	51	22	16,3	46	70,08	FI-VK-38S-HR	
1,81			1,81	2,01	.87	.64	1,81	154,17			

 Materials / surface finishings: **HR Steel**, uncoated, hardened

P

STAUFF Press Cutting Ring Pre-Assembly and Final Assembly Machine Type SPR-PRC-POC

Product Description

The STAUFF Press Assembly Machine SPR-PRC-POC allows the pressure/position-controlled pre-assembly and final assembly of cutting rings from the Extra-Light Series (LL), the Light Series (L) and the Heavy Series (S) according to ISO 8434-1 / DIN 2353 on tube ends with outer diameters between 4 mm and 42 mm.

The machine is designed as a robust table-top device for continuous operation in the workshop. It is used in connection with hardened and wear-resistant assembly studs FI-FMK and support plates FI-GP which are specially designed for the machine-assisted assembly.

The combined pressure/position-control of the device allows wear on the assembly tools to be detected in time before it can have a negative influence on the assembly result. Maximum service life of the tools is achieved through careful handling of the components and practical operation of the assembly machine. Other factors are proper storage (protected against contamination and corrosion), regular cleaning and lubrication (with suitable lubricants) and thorough preparation of the tube ends before assembly (cutting, deburring and cleaning).

Short times for tool changes, setup and assembly make it possible to carry out series assembly of cutting rings as well as assembly of small and medium quantities with a high level of economic efficiency, reproducibility and process reliability. Among other things, this is achieved with the RFID transponders – which are integrated into the support plates for automatic tool size identification as a standard – and with the tool contact switch: this allows assembly processes to be automatically started and completed by simply pushing the tube end into the assembly stud without having to press any buttons. The assembly area is secured against interference by a light grid to comply with current accident prevention regulations.

The convenient operating panel on the cutting ring assembly machine allows the user to choose between pre-assembly and final assembly at any time:

When utilising the machine-assisted 50% **pre-assembly**, the fitter then has to manually finish the assembly by tightening the union nut by 180° (corresponds to 1/2 turns) beyond the fix point. With machine-assisted **final assembly**, the cutting ring has already cut 100% into the tube and the fitter only has to tighten the union nut by 30° (corresponds to 1/12 turns) from the fix point. Please pay attention to the corresponding assembly instructions in both cases.

Final assembly (100%) minimises the risk for errors (insufficient or excessive manual tightening) and the resulting leak potentials which can often lead to time consuming and expensive machine downtimes and environmental impact. Due to the time benefits during final tightening, final assembly by machine also generates clear saving potentials compared to manual direct assembly as well as to machine-assisted pre-assembly.

In case of incorrect or incomplete assembly where pressure and position parameters significantly deviate from the values stored in the machine, it automatically stops the assembly process and displays a corresponding warning message on the operating panel.



Operating elements of the assembly machine



Noise-reducing tool tray with durable rubber mat



Electrical connection plug and Ethernet port (RJ45)



Lateral handle bars and rubber machine feet with suitable clearance height

Machine-Assisted Final Assembly (100%)
and finish the assembly by manually tightening the union nut by 30° (equivalent to 1/12 a turn)



Machine-Assisted Pre-Assembly (50%)
and finish the assembly by manually tightening the union nut by 180° (equivalent to 1/2 a turn)



■ Tube Preparation (Inspection, Cutting, De-Burring, Cleaning etc.)
 ■ Machine-Assisted Assembly Processes
 ■ Manual Assembly Processes

Time required →

Comparison of the total times required for the assembly and installation of cutting ring connections (medium size)

P



STAUFF Press Cutting Ring Pre-Assembly and Final Assembly Machine Type SPR-PRC-POC

Characteristics

Performance

- Selection between pre-assembly (50 %) and final assembly (100 %)
- Short times for tool changes, setup and assembly
- Tool size detection via RFID transponders in the support plates
- Automatic assembly start through integrated tool contact switch
- Tool wear detection through combined pressure/position-control
- Internal memory for up to 9 assembly programs which can be selected on the operating panel: predefined are tube materials steel E235 and E355 as well as stainless steel 316; parameters for other materials (copper, CuNiFe, Tungum, polyamide etc.) can be added by the manufacturer if required
- Counters for lot/batch sizes and total quantities (separated by tool size)
- Documented process control through programmable logic control (PLC)
- Predefined menu languages: English, German, French and Italian

Design

- ① Robust and ergonomically designed machine housing
- ② Optimised assembly area with approx. 80 mm / 3.15 in distance from the tube axis to the interfering edge of the machine housing, which allows processing of tubes with low bending radii or complex geometries
- ③ Noise-reducing tool tray with durable rubber mat
- ④ Lateral handle bars as attachment points for transport (e.g. with lifting belts)
- ⑤ Secure positioning thanks to flexible rubber machine feet
- ⑥ Type plate, with technical data, serial number, year of manufacture, etc.

Technical Data

Area of Application

- Function: Pre-assembly (50%) and final assembly (100%) of cutting rings on metric tube ends
- Operating principle: Assembly with combined pressure/position-control
- Series and diameters: Extra-Light Series (LL): 4, 6, 8, 10, 12 mm
Light Series (L): 6, 8, 10, 12, 15, 18, 22, 28, 35, 42 mm
Heavy Series (S): 6, 8, 10, 12, 14, 16, 20, 25, 30, 38 mm

Dimensions / Weight

- Dimensions (W x D x H): 780 mm x 650 mm x 305 mm
30.70 in x 25.29 in x 12.00 in
with lateral handle bars (detachable)
- Distance from the tube axis to the interfering edge of the machine housing: 80 mm / 3.15 in
- Clearance height: 65 mm / 2.56 in (height of the machine feet)
enables simple and safe transport using a forklift or pallet jack
- Weight: 95 kg / 210 lbs (incl. operating fluid, excl. assembly tools)

Materials

- Machine frame: Aluminium
- Machine housing: Steel, painted
- Tool tray: NBR (Perbunan®)
- Machine feet: Natural rubber
- Assembly studs: Steel, PVD coated
- Support plates: Steel, browned

Operating Elements

- ⑦ Operating panel for display and selection of all relevant settings and assembly parameters
- ⑧ Button for definite confirmation of entries made on the operating panel
- ⑨ Status light to indicate readiness for operation and running assembly processes

Safety Devices

- ⑩ Main power switch
(can be secured against unauthorised actuation when required)
- ⑪ Separate emergency stop button to immediately stop all machine movements
- ⑫ Light grid to protect users when reaching into the assembly area

Connections (at the back of the machine)

- ⑬ Electrical connection according to IEC 60309 CEE 16A (cable length: 4 m / 13.12 ft) and Ethernet connection (RJ45) for maintenance and data input by the manufacturer

Assembly Tools

- ⑭ Wear-resistant assembly stud FI-MFK
- ⑮ Support plate FI-GP with RFID transponder

Motor Configuration

- Power supply: 400 V AC @ 50 Hz - 3 phases
460 V AC @ 60 Hz - 3 phases
- Current consumption: 2,7 A
- Connected load: 0,9 kW
- Electrical connection: Phase reversing plug according to IEC 60309 CEE 16A
- Cable length: 4 m / 13.12 ft

Alternative motor configurations and plug types are available on request. Please contact STAUFF for details.

Hydraulic System

- Operating fluid: Hydraulic oil Shell Tellus S2 MA 46 or equivalent (filled and ready for operation when delivered)
- Fluid volume: 4 litres / 1.06 US Gallon
- Max working pressure: 450 bar / 6527 PSI

Operating Conditions

- Storage temperature: -10°C ... +70°C / +14°F ... +158°F
- Ambient temperature: +15°C ... +35°C / +59°F ... +95°F
- Ambient conditions: Dry, no condensing humidity, operation in horizontal position only
- Noise emission: less than 66 dB(A) as per EN ISO 11202 at full-load operation with maximum tube dimensions



Cutting Ring Assembly Stud for Machine-Assisted Assembly Type FI-MFK ▪ Series LL / L / S

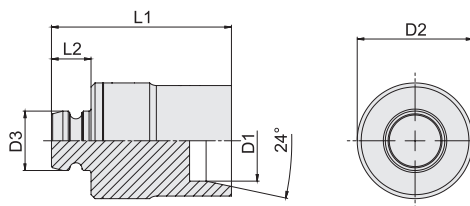

Series	Tube OD		Dimensions			Weight (^{kg} /lbs) ca. per 100	Ordering Codes
	D1 (mm/in)	D2 (mm/in)	D3	L1	L2		
LL	4	30	14,8	50	10	12,98	FI-MFK-04LL-W100
	.16	1.18	.58	1.97	.39	28.55	
	6	30	14,8	50	10	13,28	FI-MFK-06LL-W100
	.24	1.18	.58	1.97	.39	29.22	
	8	30	14,8	50	10	13,68	FI-MFK-08LL-W100
	.31	1.18	.58	1.97	.39	30.10	
L	6	30	14,8	50	10	13,57	FI-MFK-06L-W100
	.24	1.18	.58	1.97	.39	29.85	
	8	30	14,8	50	10	14,01	FI-MFK-08L-W100
	.31	1.18	.58	1.97	.39	30.82	
	10	30	14,8	50	10	14,63	FI-MFK-10L-W100
	.39	1.18	.58	1.97	.39	32.18	
	12	30	14,8	50	10	16,09	FI-MFK-12L-W100
	.47	1.18	.58	1.97	.39	35.39	
	15	30	14,8	50	10	16,63	FI-MFK-15L-W100
	.59	1.18	.58	1.97	.39	36.58	
	18	30	14,8	50	10	18,23	FI-MFK-18L-W100
	.71	1.18	.58	1.97	.39	40.10	
	22	30	14,8	49	10	19,13	FI-MFK-22L-W100
	.87	1.18	.58	1.93	.39	42.08	
	28	33,8	14,8	48	10	24,43	FI-MFK-28L-W100
	1.10	1.33	.58	1.89	.39	53.74	
	35	42,8	14,8	45	10	32,72	FI-MFK-35L-W100
1.38	1.69	.58	1.77	.39	71.99		
42	49,8	14,8	44	10	41,17	FI-MFK-42L-W100	
1.65	1.96	.58	1.73	.39	90.58		
S	6	30	14,8	50	10	14,14	FI-MFK-06S-W100
	.24	1.18	.58	1.97	.39	31.11	
	8	30	14,8	50	10	14,68	FI-MFK-08S-W100
	.31	1.18	.58	1.97	.39	32.29	
	10	30	14,8	50	10	15,23	FI-MFK-10S-W100
	.39	1.18	.58	1.97	.39	33.51	
	12	30	14,8	50	10	15,89	FI-MFK-12S-W100
	.47	1.18	.58	1.97	.39	34.95	
	14	30	14,8	49	10	15,98	FI-MFK-14S-W100
	.55	1.18	.58	1.93	.39	35.15	
	16	30	14,8	49	10	16,65	FI-MFK-16S-W100
	.63	1.18	.58	1.93	.39	36.64	
	20	30	14,8	45	10	16,43	FI-MFK-20S-W100
	.79	1.18	.58	1.77	.39	36.15	
	25	33,8	14,8	42	10	19,02	FI-MFK-25S-W100
	.98	1.33	.58	1.65	.39	41.84	
	30	39,8	14,8	40	10	22,88	FI-MFK-30S-W100
1.18	1.57	.58	1.57	.39	50.34		
38	49,8	14,8	36	10	26,41	FI-MFK-38S-W100	
1.50	1.96	.58	1.42	.39	58.10		

P

Materials / surface finishings: W100 Steel, PVD coated

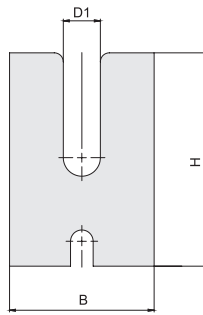
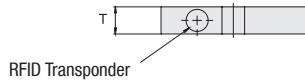

Support Plate for Machine-Assisted Assembly
 Type FI-GP • Series LL / L / S

Series	Tube OD	Dimensions			Weight (^{kg} / _{lbs}) ca. per 100	Ordering Codes
	(^{mm} / _{in}) D1	(^{mm} / _{in}) B	H	T		
LL	4	80	118	15	104,43	FI-GP-04LL-W101
	.16	3.15	4.65	.59	229.75	
	6	80	118	15	102,97	FI-GP-06LL-W101
	.24	3.15	4.65	.59	226.53	
	8	80	118	15	101,46	
L	.31	3.15	4.65	.59	223.22	FI-GP-08LL-W101
	6	80	118	15	102,97	FI-GP-06L-W101
	.24	3.15	4.65	.59	226.53	
	8	80	118	15	101,46	FI-GP-08L-W101
	.31	3.15	4.65	.59	223.22	
	10	80	118	15	99,93	FI-GP-10L-W101
	.39	3.15	4.65	.59	219.84	
	12	80	118	15	98,35	FI-GP-12L-W101
	.47	3.15	4.65	.59	216.37	
	15	80	118	15	95,91	FI-GP-15L-W101
	.59	3.15	4.65	.59	211.01	
	18	80	118	15	93,40	FI-GP-18L-W101
	.71	3.15	4.65	.59	205.47	
	22	80	118	15	89,91	FI-GP-22L-W101
	.87	3.15	4.65	.59	197.80	
	28	80	118	15	84,41	FI-GP-28L-W101
	1.10	3.15	4.65	.59	185.69	
	35	80	118	15	77,56	FI-GP-35L-W101
	1.38	3.15	4.65	.59	170.64	
	42	80	118	15	70,27	FI-GP-42L-W101
1.65	3.15	4.65	.59	154.59		
S	6	80	118	15	102,97	FI-GP-06S-W101
	.24	3.15	4.65	.59	226.53	
	8	80	118	15	101,46	FI-GP-08S-W101
	.31	3.15	4.65	.59	223.22	
	10	80	118	15	99,93	FI-GP-10S-W101
	.39	3.15	4.65	.59	219.84	
	12	80	118	15	98,35	FI-GP-12S-W101
	.47	3.15	4.65	.59	216.37	
	14	80	118	15	96,73	FI-GP-14S-W101
	.55	3.15	4.65	.59	212.81	
	16	80	118	15	95,08	FI-GP-16S-W101
	.63	3.15	4.65	.59	209.18	
	20	80	118	15	91,67	FI-GP-20S-W101
	.79	3.15	4.65	.59	201.68	
	25	80	118	15	87,20	FI-GP-25S-W101
	.98	3.15	4.65	.59	191.84	
	30	80	118	15	82,50	FI-GP-30S-W101
	1.18	3.15	4.65	.59	181.49	
38	80	118	15	74,49	FI-GP-38S-W101	
1.50	3.15	4.65	.59	163.88		

Materials / surface finishings: W101 Steel, browned



STAUFF Press Combined Cutting Ring Assembly and 37° Tube Flaring Machine with Automatic or Manual Pressure Setting and Control ▪ Type SPR-PRC-MA

Product Description

The electro-hydraulically operated STAUFF Press Assembly Machine SPR-PRC-MA allows the assembly of cutting rings in the Light Series (L) as well as in the Heavy Series (S) according to ISO 8434-1 / DIN 2353 on metric tube ends with outer diameters from 4 mm to 42 mm.

Exchangeable heads allows the device to be adapted for 37° flaring of metric and imperial tube ends with outer diameters from 4 mm to 42 mm and from 1/4 in to 1 1/2 in respectively according to DIN 3949 or SAE J514 / ISO 8434-2.

Short times for tool changes, setup and assembly (even when changing the assembly type from cutting ring assembly to 37° tube flaring) make it possible to carry out series production as well as the assembly of small and medium quantities with a high level of economic efficiency, reproducibility and process reliability with considerable reduction of times and cost of assembly of fittings.

The adjustable return stroke of the cylinder helps the operator to further optimise the total cycle times.

The machine is designed as a robust table-top device for continuous operation in the workshop. It is used in connection with hardened and wear-resistant assembly tools which are specially designed for the machine-assisted assembly.



Tooling head for cutting ring assembly based on pre-defined settings / automatic tool size detection



Tooling head for cutting ring assembly based on settings manually defined by the operator



Tooling head for 37° tube flaring based on settings manually defined by the operator



Smart programmable control panel with push/turn button and back-lit parameter display



Noise-reducing tool tray with durable rubber mat



Robust rubber feet providing secure positioning and dampening during operation



USB connection for maintenance and data input by the manufacturer



Electrical connection with a phase reversing plug according to IEC 60309 CEE 16A



Connections for the tool head as well as for the external hand control switch (available on request)

P



STAUFF Press

Combined Cutting Ring Assembly and 37° Tube Flaring Machine with Automatic or Manual Pressure Setting and Control ▪ Type SPR-PRC-MA

Characteristics

Performance

- Pressure-controlled assembly of cutting rings on metric tube ends as well as 37° tube flaring of metric/imperial tube ends due to exchangeable tool heads
- Cutting ring assembly with Tooling Head SPR-PRC-TH-C-A based on pre-defined pressure settings (with automatic tool size detection) or with Tooling Head SPR-PRC-TH-C-M based on pressure settings as manually defined by the operator
- Short times for tool and head changes, setup and assembly (even when changing the assembly type from cutting ring assembly to 37° tube flaring)
- Adjustable return stroke of the cylinder in order to further optimise the total cycle times
- Internal memory for up to 8 assembly programs which can be selected on the operating panel: predefined are tube materials steel E235 and E355 as well as stainless steel 316; parameters for other materials (copper, CuNiFe, Tungum, polyamide etc.) can be added by the manufacturer if required
- Counters for lot/batch sizes and total quantities
- Operator-friendly and easy to maintain and service

Design

- ① Robust and compact table-top device allowing for maximum mobility and flexibility
- ② Optimised assembly area with approx. 80 mm / 3.15 in distance from the tube axis to the interfering edge of the machine housing, which allows processing of tubes with low bending radii or complex geometries
- ③ Noise-reducing tool tray with durable rubber mat
- ④ Lateral handle bars as attachment points for transport (e.g. with lifting belts)
- ⑤ Robust rubber feet providing secure positioning and dampening during operation
- ⑥ Type plate, with technical data, serial number, year of manufacture, etc.

Technical Data

Area of Application

- Function: Pressure-controlled assembly of cutting rings
Light (L): 6, 8, 10, 12, 15, 18, 22, 28, 35, 42 mm
Heavy (S): 6, 8, 10, 12, 14, 16, 20, 25, 30, 38 mm
- Pressure-controlled 37° flaring of metric tube ends (according to DIN 3949 bzw. SAE J 514 / ISO 8434-2):
Light (L): from 6 x 1 mm to 42 x 4 mm
Heavy (S): from 6 x 1 mm to 38 x 5 mm
- Pressure-controlled 37° flaring of imperial tube ends (according to SAE J 514 / ISO 8434-2):
1/4, 5/16, 3/8, 1/2, 5/8, 3/4, 7/8, 1, 1-1/4, 1-1/2 inch

Dimensions / Weight

- Dimensions (W x D x H): 660 mm x 515 mm x 265 mm
25.98 in x 20.28 in x 10.43 in
with lateral handle bars (detachable)
- Distance from the tube axis to the interfering edge of the machine housing: 80 mm / 3.15 in
- Clearance height: 30 mm / 1.18 in (height of the machine feet)
- Weight (basic machine): 66 kg / 145 lbs
(incl. operating fluid, excl. assembly tools)
- Weight (tooling heads): SPR-PRC-TH-C-A: 6,0 kg / 13 lbs
SPR-PRC-TH-C-M: 5,5 kg / 12 lbs
SPR-PRC-TH-F-M: 19,5 kg / 43 lbs

Materials

- Machine frame: Steel
- Machine cover: Plastic
- Tool tray: NBR (Perbunan®)
- Machine feet: Natural rubber
- Assembly tools: Steel, uncoated, hardened

Operating Elements

- ⑦ Push/turn control button to select all relevant settings and assembly parameters
- ⑧ Smart programmable control panel with back-lit parameter display
- ⑨ Button for definite confirmation of entries made on the operating panel
- ⑩ Illuminated pushbutton to reset the cylinder and to indicate incorrect assemblies

Safety Devices

- ⑪ Selector switch to choose the operation mode (can be locked with a key and secured against unauthorised actuation, if required)
- ⑫ Main power switch
- ⑬ Separate emergency stop button to immediately stop all machine movements

Connections

- ⑭ Electrical connection according to IEC 60309 CEE 16A (cable length: 4 m / 13.12 ft)
- ⑮ USB connection for maintenance and data input by the manufacturer
- ⑯ Connections for tool heads for cutting ring assembly based on pre-defined pressure settings as well as for the external hand control switch SPR-PRC-HS (available on request)

Assembly Tools

- Tooling head SPR-PRC-TH-C-A for cutting ring assembly based on automatic pressure setting (50% pre-assembly is pre-defined) and with tool size detection via the support plates
- Tooling head SPR-PRC-TH-C-M for cutting ring assembly based on manual settings
- Tooling head SPR-PRC-TH-F-M for 37° tube flaring based on manual settings
- Wear-resistant cutting ring assembly stud FI-MVK-...-PRC
- Support plate FI-GP-...-PRC
- Clamping jaws FI-KB-...-PRC for 37° tube flaring

Motor Configuration

- Power supply: 400 V AC @ 50 Hz - 3 phases
- Current consumption: 2,8 A
- Connected load: 1,2 kW
- Electrical connection: Phase reversing plug according to IEC 60309 CEE 16A
- Cable length: 4 m / 13.12 ft

Alternative motor configurations and plug types are available on request. Please contact STAUFF for details.

Hydraulic System

- Operating fluid: Hydraulic oil Shell Nuto H 32 or equivalent (filled and ready for operation when delivered)
- Fluid volume: 4 litres / .78 US Gallon
- Max working pressure: 200 bar / 2901 PSI

Operating Conditions

- Storage temperature: -10°C ... +70°C / +14°F ... +158°F
- Ambient temperature: +10°C ... +50°C / +50°F ... +122°F
- Ambient conditions: Dry, no condensing humidity, operation in horizontal position only
- Noise emission: less than 60 dB(A) as per EN ISO 11202



Tooling Head for Cutting Ring Assembly (based on pre-defined settings)

Type SPR-PRC-TH-C-A



- Tooling head SPR-PRC-TH-C-A for cutting ring pre-assembly based on pre-defined settings and with automatic tool size detection via the support plates
- Requires cutting ring assembly studs FI-MVK-PRC and support plates FI-GP-PRC

Tooling Head for Cutting Ring Assembly (based on manual settings)

Type SPR-PRC-TH-C-M



- Tooling head SPR-PRC-TH-C-M for cutting ring pre-assembly based on manual settings
- Requires cutting ring assembly studs FI-MVK-PRC and support plates FI-GP-PRC

Tooling Head for 37° Tube Flaring (based on manual settings)

Type SPR-PRC-TH-F-M



- Tooling head SPR-PRC-TH-F-M for 37° tube flaring based on manual settings
- Requires clamping jaws FI-KB-PRC

Assembly Tool Magazine

Type SPR-TM



- Provides safe and convenient storage for up to 10 assembly studs (types FI-MFK and FI-MVK-PRC) as well as up to 10 support plates (types FI-GP and FI-GP-PRC) for the machine-assisted cutting ring assembly
- Assembly studs and support plates are not included in the scope of delivery for this item and have to be ordered separately

External Hand Control Switch

Type SPR-PRC-HS

- Enables the operator to trigger assembly processes from a larger distance to the machine (cable length: 3 m / 9.84 ft)



Cutting Ring Assembly Stud for Machine-Assisted Assembly Type FI-MVK-PRC • Series L / S



Series	Tube OD (^{mm} / _{in})	Ordering Codes
L	6	FI-MVK-06L-PRC-W1
	.24	
	8	FI-MVK-08L-PRC-W1
	.31	
	10	FI-MVK-10L-PRC-W1
	.39	
	12	FI-MVK-12L-PRC-W1
	.47	
	15	FI-MVK-15L-PRC-W1
	.59	
	18	FI-MVK-18L-PRC-W1
	.71	
	22	FI-MVK-22L-PRC-W1
	.87	
	28	FI-MVK-28L-PRC-W1
	1.10	
	35	FI-MVK-35L-PRC-W1
1.38		
42	FI-MVK-42L-PRC-W1	
1.65		
S	6	FI-MVK-06S-PRC-W1
	.24	
	8	FI-MVK-08S-PRC-W1
	.31	
	10	FI-MVK-10S-PRC-W1
	.39	
	12	FI-MVK-12S-PRC-W1
	.47	
	14	FI-MVK-14S-PRC-W1
	.55	
	16	FI-MVK-16S-PRC-W1
	.63	
	20	FI-MVK-20S-PRC-W1
	.79	
	25	FI-MVK-25S-PRC-W1
	.98	
	30	FI-MVK-30S-PRC-W1
1.18		
38	FI-MVK-38S-PRC-W1	
1.50		

Materials / surface finishings: **W1** Steel, uncoated, hardened



Support Plate for Machine-Assisted Cutting Ring Assembly
Type FI-GP-PRC • Series L / S



Series	Tube OD (mm/in)	Ordering Codes
L	6	FI-GP-06L/S-PRC-A-W1
	.24	
	8	FI-GP-08L/S-PRC-A-W1
	.31	
	10	FI-GP-10L/S-PRC-A-W1
	.39	
	12	FI-GP-12L/S-PRC-A-W1
	.47	
	15	FI-GP-15L-PRC-A-W1
	.59	
	18	FI-GP-18L-PRC-A-W1
	.71	
	22	FI-GP-22L-PRC-A-W1
	.87	
	28	FI-GP-28L-PRC-A-W1
	1.10	
	35	FI-GP-35L-PRC-A-W1
1.38		
42	FI-GP-42L-PRC-A-W1	
1.65		
S	6	FI-GP-06L/S-PRC-A-W1
	.24	
	8	FI-GP-08L/S-PRC-A-W1
	.31	
	10	FI-GP-10L/S-PRC-A-W1
	.39	
	12	FI-GP-12L/S-PRC-A-W1
	.47	
	14	FI-GP-14S-PRC-A-W1
	.55	
	16	FI-GP-16S-PRC-A-W1
	.63	
	20	FI-GP-20S-PRC-A-W1
	.79	
	25	FI-GP-25S-PRC-A-W1
	.98	
	30	FI-GP-30S-PRC-A-W1
1.18		
38	FI-GP-38S-PRC-A-W1	
1.50		

Materials / surface finishings: **W1** Steel, uncoated, hardened



Clamping Jaws for 37° Tube Flaring
 Type FI-KB • Series L / S

37° Flaring of Metric Tube Ends

Series	Tube OD (mm/in)	Ordering Codes	
		DIN 3949	SAE J514 / ISO 8434-2
L	6	FI-KB-06L/S-PRC-MF-W1	FI-KB-06L/S-PRC-F-W1
	.24		
	8	FI-KB-08L/S-PRC-MF-W1	FI-KB-08L/S-PRC-F-W1
	.31		
	10	FI-KB-10L/S-PRC-MF-W1	FI-KB-10L/S-PRC-F-W1
	.39		
	12	FI-KB-12L/S-PRC-MF-W1	FI-KB-12L/S-PRC-F-W1
	.47		
	15	FI-KB-15L-PRC-MF-W1	
	.59		
	18	FI-KB-18L-PRC-MF-W1	FI-KB-18L-PRC-F-W1
	.71		
	22	FI-KB-22L-PRC-MF-W1	
	.87		
	28	FI-KB-28L-PRC-MF-W1	FI-KB-28L-PRC-F-W1
	1.10		
35	FI-KB-35L-PRC-MF-W1	FI-KB-35L-PRC-F-W1	
1.38			
42	FI-KB-42L-PRC-MF-W1	FI-KB-42L-PRC-F-W1	
1.65			
S	6	FI-KB-06L/S-PRC-MF-W1	FI-KB-06L/S-PRC-F-W1
	.24		
	8	FI-KB-08L/S-PRC-MF-W1	FI-KB-08L/S-PRC-F-W1
	.31		
	10	FI-KB-10L/S-PRC-MF-W1	FI-KB-10L/S-PRC-F-W1
	.39		
	12	FI-KB-12L/S-PRC-MF-W1	FI-KB-12L/S-PRC-F-W1
	.47		
	14	FI-KB-14S-PRC-MF-W1	
	.55		
	16	FI-KB-16S-PRC-MF-W1	FI-KB-16S-PRC-F-W1
	.63		
	20	FI-KB-20S-PRC-MF-W1	FI-KB-20S-PRC-F-W1
	.79		
	25	FI-KB-25S-PRC-MF-W1	FI-KB-25S-PRC-F-W1
	.98		
	30	FI-KB-30S-PRC-MF-W1	
	1.18		
	30 x 5	FI-KB-30SX5-PRC-MF-W1	
1.18 x .20			
38	FI-KB-38S-PRC-MF-W1	FI-KB-38S-PRC-F-W1	
1.50			
38 x 5	FI-KB-38SX5-PRC-MF-W1		
1.50 x .20			

37° Flaring of Imperial Tube Ends

Tube OD (mm/in)	Ordering Codes
	SAE J514 / ISO 8434-2
1/4	FI-KB-1/4-PRC-F-W1
5/16	FI-KB-08L/S-PRC-F-W1
3/8	FI-KB-3/8-PRC-F-W1
1/2	FI-KB-1/2-PRC-F-W1
5/8	FI-KB-5/8-PRC-F-W1
3/4	FI-KB-3/4-PRC-F-W1
7/8	FI-KB-7/8-PRC-F-W1
1	FI-KB-1-PRC-F-W1
1-1/4	FI-KB-1-1/4-PRC-F-W1
1-1/2	FI-KB-38S-PRC-F-W1

Materials / surface finishings: W1 Steel, uncoated, hardened



STAUFF Press Portable Cutting Ring Assembly Machine with Manual Pressure Setting (Set) Type SPR-PRC-H-SET

Product Description

With the battery-operated STAUFF Press Assembly Machine SPR-PRC-H-M, STAUFF provides an ergonomically designed, light-weight and at the same time robust device for the assembly of cutting rings in the Light Series (L) as well as in the Heavy Series (S) according to ISO 8434-1 / DIN 2353 on metric tube ends with outer diameters from 6 mm to 42 mm.

The machine has been designed for hand-held, tripod- or table-mounted operation and offers the best technical compromise between maximum flexibility, economic efficiency and a high level of process reliability with considerable reduction of time and cost for the assembly of cutting ring fittings.

Short tool change and setup times (with only a few seconds required to manually adjust the assembly pressure) make it possible to carry out the assembly of medium and even small quantities of cutting ring fittings, e.g. during maintenance, servicing, conversion and repair works on hydraulic pipe and tube systems. With the rechargeable battery being able to typically cover more than 200 assembly cycles per charge (depending on pressure settings and other influencing factors), the machine is also suitable for mass processing and production.

The assembly machine is by default supplied in a heavy-duty trolley transport case that is equipped with a range of accessories and also provides suitable space for the assembly studs.



Mode dial to manually adjust the pressure (settings indicated on the machine housing)



Status lights on the back of the machine housing



Assembly machine attached to a tripod stand using a mounting bracket



P



STAUFF Press Portable Cutting Ring Assembly Machine with Manual Pressure Setting (Set) Type SPR-PRC-H-SET

Technical Data

Area of Application

- Function: Pressure-controlled assembly of cutting rings acc. to ISO 8434-1 / DIN 2353 on metric tube ends
Light (L): 6, 8, 10, 12, 15, 18, 22, 28, 35 and 42 mm
Heavy (S): 6, 8, 10, 12, 14, 16, 20, 25, 30 and 38 mm

Dimensions / Weight

- Dimensions (L x H x W): 440 mm x 330 mm x 80 mm
17.32 in x 12.99 in x 3.15 in
(including rechargeable battery)
- Weight (basic machine): 6,8 kg / 15 lbs
(including rechargeable battery)
- Weight (case): 16,5 kg / 36 lbs
(including assembly machine and accessories)
- Case: IP67 certified, equipped with o-ring seal and automatic pressure valve

Materials

- Machine cover: Plastic
- Tool head: Steel, uncoated, hardened
- Assembly studs: Stainless steel, hardened

Rechargeable Battery

- Typically covers more than 200 assembly cycles per charge (depending on pressure settings and other influencing factors)
- Battery type: Lithium-ion (18V / 3.0 Ah)

Charging Unit

- Charging time for empty batteries is approximately 75 minutes
- Power supply: 230 V AC @ 50 Hz - single-phase
- Electrical connection: 2-pin grounded safety plug (CEE 7/4, type F / Schuko)
- Cable length: 1,10 m / 3.61 ft

List of Components

Set supplied in a heavy-duty trolley transport case:

- ① Light-weight and ergonomically designed cutting ring assembly machine for the hand-held, tripod-mounted or table-mounted operation
- ② Rechargeable battery
- ③ Additional replacement battery
- ④ Battery quick charging unit
- ⑤ Clips (to keep the assembly stud in position)

Not displayed: Shoulder strap

Equipment to be ordered separately:

- ⑥ Assembly oil (to lubricate the taper of the assembly stud)
- ⑦ Cutting Ring Assembly Studs **FI-MVK-PRC-H-M-HR**

Accessories

- Tripod Stand **SPR-PRC-H-M-TP**
- Table Stand **SPR-PRC-H-M-TS**
- Mounting Bracket **SPR-PRC-H-M-MH**
(required as a machine holder for both the tripod stand and the table stand)

Spare Parts

- Assembly oil **SPR-PRC-H-M-OS**
(required to lubricate the taper of the assembly stud)
- Rechargeable Battery **SPR-PRC-H-M-BP**
- Battery Quick Charging Unit **SPR-PRC-H-M-BC**



Cutting Ring Assembly Stud for Machine-Assisted Assembly
Type FI-MVK-PRC-H-M ▪ Series L / S



Series	Tube OD (mm/in)	Ordering Codes
L	6	FI-MVK-06L-PRC-H-M-HR
	.24	
	8	FI-MVK-08L-PRC-H-M-HR
	.31	
	10	FI-MVK-10L-PRC-H-M-HR
	.39	
	12	FI-MVK-12L-PRC-H-M-HR
	.47	
	15	FI-MVK-15L-PRC-H-M-HR
	.59	
	18	FI-MVK-18L-PRC-H-M-HR
	.71	
	22	FI-MVK-22L-PRC-H-M-HR
	.87	
	28	FI-MVK-28L-PRC-H-M-HR
	1.10	
	35	FI-MVK-35L-PRC-H-M-HR
1.38		
42	FI-MVK-42L-PRC-H-M-HR	
1.65		
S	6	FI-MVK-06S-PRC-H-M-HR
	.24	
	8	FI-MVK-08S-PRC-H-M-HR
	.31	
	10	FI-MVK-10S-PRC-H-M-HR
	.39	
	12	FI-MVK-12S-PRC-H-M-HR
	.47	
	14	FI-MVK-14S-PRC-H-M-HR
	.55	
	16	FI-MVK-16S-PRC-H-M-HR
	.63	
	20	FI-MVK-20S-PRC-H-M-HR
	.79	
	25	FI-MVK-25S-PRC-H-M-HR
	.98	
	30	FI-MVK-30S-PRC-H-M-HR
1.18		
38	FI-MVK-38S-PRC-H-M-HR	
1.50		

Materials / surface finishing: **HR** Stainless steel, hardened



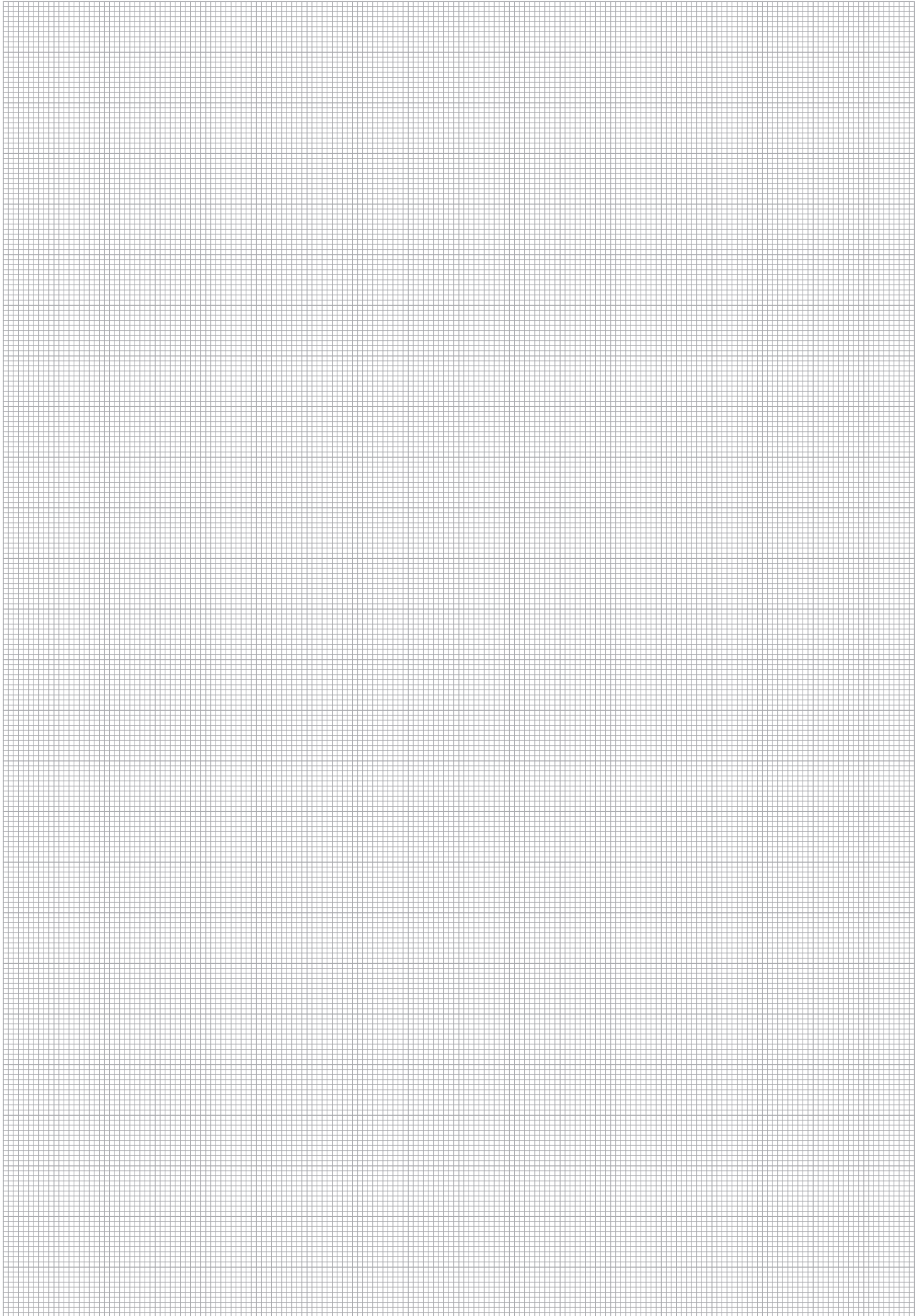

P



STAUFF Form Tube Forming Machine Type SF0-F

Product Description

The type SF0-F tube forming machine facilitates the economical and most reliable production of tube ends made of steel, stainless steel and other materials with a contour typical for the STAUFF Form tube forming system.

The machine is designed as a robust table-top device for continuous operation in the workshop. It is used in connection with FI-FST tube shapers and FI-FB clamping jaws. Tube shapers with FI-ID internal tube supports are used with selected tube dimensions, which prevent the tube from being constricted in the shaping area.

Tube shapers, clamping jaws and internal tube supports have been specifically designed for the mechanical forming process and can be quickly and simply replaced without the need for any tools, if required. The resulting short tool change and set-up times contribute to the high efficiency of the system as well as ensuring low cycle times.

All the tools needed for the forming process are clearly labelled with the tube dimensions so that assembly errors caused by incorrect assignment can be largely ruled out.



Operating elements of the tube forming machine



Noise-reducing tool tray with durable rubber mat



Lateral handle bars and rubber machine feet with suitable clearance height

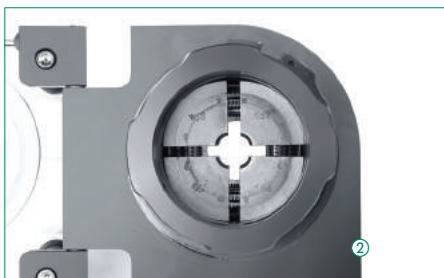

Open clamping head with clamping jaws inserted



Inserting the tube shaper into the tool holder – with no tools required



Electrical connection plug and Ethernet port (RJ45)

P



STAUFF Form Tube Forming Machine Type SFO-F

Characteristics

Performance

- Constant high process safety, reliability and reproducibility by the position-control of the machine, which performs the shaping process following a manual start and monitors it by means of stored parameters
- Maximum efficiency thanks to short cycle times – ideal for series production
- Quick and simple replacement of tube shapers (with bayonet lock) and clamping jaws when changing the tube dimensions – with no tools required
- Potential risk of confusion and assembly errors caused by incorrect assignment can virtually be ruled out by the clear labelling of all assembly tools
- Surface-friendly clamping of the tube during the forming process
- Counters for lot/batch sizes and total quantities (separated by tool size)
- Predefined menu languages: English, German, French and Italian
- High degree of user comfort with clear information displayed on the operating panel

Design

- ① Robust and ergonomically designed machine housing
- ② Easily accessible clamping head for simple positioning of the clamping jaws and optimised assembly area with approx. 115 mm / 4.52 in distance from the tube axis to the interfering edge of the machine housing, which allows processing of tubes with low bending radii or complex geometries
- ③ Noise-reducing tool tray with durable rubber mat
- ④ Lateral handle bars as attachment points for transport (e.g. with lifting belts)
- ⑤ Secure positioning thanks to flexible rubber machine feet
- ⑥ Type plate, with technical data, serial number, year of manufacture etc.

Technical Data

Area of Application

- **Function:** Cold forming of seamless cold drawn precision steel tubes acc. to EN 10305-1 (materials E235, E355) and stainless steel tubes (material 1.4571 / AISI 316 Ti)

Parameters for alternative materials (copper, brass, CuNiFe, Tungum etc.) can be added by the manufacturer, if required. Please contact STAUFF for details.

- **Operating principle:** Tube forming with combined pressure/position-control
- **Series and dimensions:** Light Series (L): 6 x 1,5 mm to 42 x 4 mm
Heavy Series (S): 6 x 1,5 mm to 38 x 6 mm

Dimensions / Weight

- **Dimensions (W x D x H):** 850 mm x 890 mm x 330 mm
33.46 in x 35.04 in x 12.99 in
with lateral handle bars (detachable)
- **Distance from the tube axis to the interfering edge of the machine housing:** 115 mm / 4.52 in
- **Clearance height:** 65 mm / 2.56 in (height of the machine feet)
enables simple and safe transport using a forklift or pallet jack
- **Weight:** 210 kg / 463 lbs
(including operating fluid, excluding forming tools)

Materials

- **Machine frame:** Aluminium
- **Machine housing:** Steel, painted
- **Tool tray:** NBR (Perbunan®)
- **Machine feet:** Natural rubber
- **Form rings:** Steel, zinc/nickel-plated
- **Form rings (seal):** FKM (Viton®)

Operating Elements

- ⑦ Operating panel for display and selection of all relevant settings and forming parameters
- ⑧ Button for definite confirmation of entries made on the operating panel
- ⑨ Status light to indicate readiness for operation and running assembly processes

Safety Devices

- ⑩ Main power switch
(can be secured against unauthorised actuation when required)
- ⑪ Separate emergency stop button to immediately stop all machine movements

Connections (at the back of the machine)

- ⑫ Electrical connection according to IEC 60309 CEE 16A (cable length: 4 m / 13.12 ft) and Ethernet connection (RJ45) for maintenance and data input by the manufacturer

Tube Forming Tools

- ⑬ Tube Shaper FI-FST with clear identification of the tube dimensions
- ⑭ Version of a Tube Shaper FI-FST with Internal Tube Support FI-ID
- ⑮ Clamping Jaws FI-FB with clear identification of the tube dimension

Motor Configuration

- **Power supply:** 400 V AC @ 50 Hz - 3 phases
460 V AC @ 60 Hz - 3 phases
- **Current consumption:** 2,55 A
- **Connected load:** 1,0 kW
- **Electrical connection:** Phase reversing plug according to IEC 60309 CEE 16A
- **Cable length:** 4 m / 13.12 ft

Alternative motor configurations and plug types are available on request. Please contact STAUFF for details.

Hydraulic System

- **Operating fluid:** Hydraulic oil Shell Tellus S2 MA 46 or equivalent (filled and ready for operation when delivered)
- **Fluid volume:** 6,1 litres / 1.61 US Gallon
- **Max working pressure:** 700 bar / 10153 PSI

Operating Conditions

- **Storage temperature:** -10°C ... +70°C / +14°F ... +158°F
- **Ambient temperature:** +15°C ... +35°C / +59°F ... +95°F
- **Ambient conditions:** Dry, no condensing humidity, operation in horizontal position only less than 69 dB(A) as per EN ISO 11202 at full-load operation with maximum tube dimensions
- **Noise emission:**



Tube Shapers ▪ Type FI-FST
Internal Tube Supports ▪ Type FI-ID



Tube OD		Tube Wall Thickness		Weight per piece		Ordering Codes	
(mm)	(in)	(mm)	(in)	(kg) ca.	(lbs) ca.	Tube Shapers	Internal Tube Supports
6	.24	1,5	.06	1,7	3.74	FI-FST-06L/S-S-A	
8	.31	1,5 2,0	.06 .08	1,7	3.74	FI-FST-08L/S-S-A	
10	.39	1,5 2,0 2,5 3,0	.06 .08 .10 .12	1,7	3.74	FI-FST-10L/S-S-A	
12	.47	1,5 2,0 2,5 3,0	.06 .08 .10 .12	1,7	3.74	FI-FST-12L/S-1.5-S-A FI-FST-12L/S-2.0/2.5/3.0-S-A	FI-ID-12x1.5-HR
15	.59	1,5 2,0 2,5	.06 .08 .10	1,7	3.74	FI-FST-15L-S-A	FI-ID-15x1.5-HR FI-ID-15x2.0-HR FI-ID-15x2.5-HR
16	.63	2,0 2,5 3,0 4,0	.08 .10 .12 .16	1,7	3.74	FI-FST-16S-2.0/2.5-S-A FI-FST-16S-3.0/4.0-S-A	FI-ID-16x2.0-HR FI-ID-16x2.5-HR
18	.71	2,0 2,5 3,0	.08 .10 .12	1,7	3.74	FI-FST-18L-2.0/2.5-S-A FI-FST-18L-3.0-S-A	FI-ID-18x2.0-HR FI-ID-18x2.5-HR
20	.79	2,0 2,5 3,0 4,0	.08 .10 .12 .16	1,7	3.74	FI-FST-20S-2.0/2.5-S-A FI-FST-20S-3.0/4.0-S-A	FI-ID-20x2.0-HR FI-ID-20x2.5-HR
22	.87	2,0 2,5 3,0 3,5	.08 .10 .12 .14	1,7	3.74	FI-FST-22L-2.0/2.5-S-A FI-FST-22L-3.0/3.5-S-A	FI-ID-22x2.0-HR FI-ID-22x2.5-HR
25	.98	2,5 3,0 3,5 4,0 5,0	.08 .10 .12 .16 .20	1,7	3.74	FI-FST-25S-2.0/2.5-S-A FI-FST-25S-3.0/3.5/4.0/5.0-S-A	FI-ID-25x2.0-HR FI-ID-25x2.5-HR
28	1.10	2,0 2,5 3,0 3,5 4,0	.08 .10 .12 .14 .16	1,7	3.74	FI-FST-28L-2.0/2.5/3.0-S-A FI-FST-28L-3.5/4.0-S-A	FI-ID-28x2.0-HR FI-ID-28x2.5-HR FI-ID-28x3.0-HR
30	1.18	2,5 3,0 4,0 5,0 6,0	.10 .12 .16 .20 .24	1,6	3.52	FI-FST-30S-2.5/3.0-S-A FI-FST-30S-4.0/5.0/6.0-S-A	FI-ID-30x2.5-HR FI-ID-30x3.0-HR
35	1.38	2,5 3,0 4,0 5,0	.10 .12 .16 .20	1,6	3.52	FI-FST-35L-2.5/3.0-S-A FI-FST-35L-4.0/5.0-S-A	FI-ID-35x2.5-HR FI-ID-35x3.0-HR
38	1.50	3,0 4,0 5,0 6,0	.12 .16 .20 .24	1,7	3.74	FI-FST-38S-3.0/4.0-S-A FI-FST-38S-5.0/6.0-S-A	FI-ID-38x3.0-HR FI-ID-38x4.0-HR
42	1.65	3,0 3,5 4,0	.12 .14 .16	1,6	3.52	FI-FST-42L-S-A	FI-ID-42x3.0-HR FI-ID-42x3.5-HR FI-ID-42x4.0-HR

Materials / surface finishings: HR Steel, uncoated, hardened

Please note:

The selection chart is only applicable in conjunction with seamless cold drawn precision steel tubes according to EN 10305-1 (materials E235 and E355). Please consult STAUFF for information regarding the processing of tubes made from stainless steel and other materials.

P



Clamping Jaws ▪ Type FI-FB



Tube OD (mm/in)	Series	Weight per piece (kg/lbs) ca.	Ordering Codes
6	L / S	2,40	FI-FB-06L/S-A
.24		5.28	
8	L / S	2,40	FI-FB-08L/S-A
.31		5.28	
10	L / S	2,30	FI-FB-10L/S-A
.39		5.06	
12	L / S	2,30	FI-FB-12L/S-A
.47		5.06	
15	L	2,30	FI-FB-15L-A
.59		5.06	
16	S	2,30	FI-FB-16S-A
.63		5.06	
18	L	2,20	FI-FB-18L-A
.71		4.84	
20	S	2,20	FI-FB-20S-A
.79		4.84	
22	L	2,20	FI-FB-22L-A
.87		4.84	
25	S	2,20	FI-FB-25S-A
.98		4.84	
28	L	2,10	FI-FB-28L-A
1.10		4.62	
30	S	2,00	FI-FB-30S-A
1.18		4.40	
35	L	2,00	FI-FB-35L-A
1.38		4.40	
38	S	1,90	FI-FB-38S-A
1.50		4.18	
42	L	1,80	FI-FB-42L-A
1.65		3.96	



STAUFF Clean Pipe, Tube and Hose Cleaning System

Product Description

The STAUFF Clean System comprises of a pneumatic launcher and a range of specially designed nozzles and projectiles.

The launcher uses standard industrial compressed air pressure between 6 and 8 bar / 87 and 116 PSI to propel a foam projectile through the nozzle and into the pipe, tube or hose bore to have their inside surface cleaned from any unwanted contamination.

This provides a safe and environmentally friendly tool that requires little formal expertise to operate and apply.

The **launcher** is the part of the system that controls the air supply to propel the projectile from start to finish of the cleaning job.

The **nozzles** are specially designed to affect an airtight seal on any pipe, tube or hose with or without end fittings. Its main purpose is to compress the foam projectile allowing it to enter the internal diameter of the pipe, tube or hose to be cleaned.

The **projectile** is the part of the system that does the cleaning: The foam projectile is sized to be approximately 15% larger than the internal diameter of the pipe, tube or hose to be cleaned. The compression of the projectile against the internal wall cleans the internal surface and expels any loose contaminants from the end of the pipe, tube or hose.

The STAUFF Clean System is available as separate components or in a variety of kit forms comprising various nozzle types, adaptor and launcher, all contained in a heavy duty carrying case.



STAUFF Clean Launchers / Launcher Kits



Characteristics

- Pneumatic pistol-grip launcher
- Light-weight and ergonomic design
- Easy to operate and apply
- Connection to air supply with quick release coupling
- Suitable for any type of nozzle
- Delivered separately or in a variety of kit forms including carrying case, adaptor ring and nozzles (if required)

Technical Data

- Air compressor requirement:
6 ... 8 bar / 87 ... 116 PSI
- Effective air volume:
250 ... 400 l/min / 66 ... 106 US GPM

Ordering Codes

- Launcher only **SC-LG**
- Launcher kit (launcher, kit and adaptor) **SC-LK**
- Kit (as above)
with set of 10 Universal nozzles **SC-10UV-K**
- Kit (as above)
with set of 18 Metric Tube nozzles **SC-18MT-K**
- Kit (as above)
with set of 10 JIC nozzles **SC-10J-K**
- Kit (as above)
with set of 7 BSP nozzles **SC-7B-K**
- Kit (as above)
with set of 7 NPT nozzles **SC-7N-K**

Contact STAUFF for alternative connection adaptors and couplings.



STAUFF Clean Nozzles / Nozzle Sets

Universal Nozzle Set (SC-U-SET)

The Universal Nozzle is designed with a tapered seat that will allow it to suit for 90% of applications, including Hose, Tube and Pipe, with or without fittings, in hydraulic and pneumatic pipe systems, condenser tubes, boiler tubes and food lines.

The Universal Nozzle kit fits all and will accommodate applications with JIC, SAE and BSP end fittings.

The set of 10 nozzles consists of the following sizes: 6 mm, 8 mm, 10 mm, 13 mm, 16 mm, 19 mm, 25 mm and 32 mm.

JIC Nozzle Set (SC-J-SET)

The JIC Nozzle is designed specifically for use with JIC and SAE type fittings. The nozzles are machined to accommodate both male and female configuration, ensuring a perfect airtight seal every time.

The set of 10 nozzles consist of the following sizes: 6 mm, 8 mm, 10 mm, 13 mm, 16 mm, 19 mm, 25 mm, 32 mm, 38 mm and 50 mm.

Metric Tube Nozzle Set (SC-M-SET)

The Metric Tube Nozzle is intended for use specifically with Metric sized tube and is designed to fit over the outside of the tube or pipe being cleaned.

The inside diameter of the nozzle is reduced to match the inside diameter of the tube. The nozzles are machined from solid bar stock and designed for superior strength.

The set of 18 nozzles consist of the following sizes: 6 mm, 8 mm, 10 mm, 12 mm, 14 mm, 15 mm, 16 mm, 18 mm, 20 mm, 22 mm, 25 mm, 28 mm, 30 mm, 35 mm, 38 mm, 42 mm, 50 mm and 60 mm.

BSP Nozzle Set (SC-B-SET)

The BSP Nozzle is designed specifically for BSP configuration fittings. The nozzles are machined to accommodate both male and female configurations, ensuring a perfect airtight seal every time.

The set of 7 nozzles consist of the following sizes: 6 mm, 10 mm, 13 mm, 16 mm, 19 mm, 25 mm and 32 mm.



Adaptor Ring for Nozzels (SCN-AR)
Required for sizes 6-32 mm / 1/4-1 1/4 in

If required, nozzles can be supplied separately. Contact STAUFF for details.

NPT Nozzle Set (SC-N-SET)

The NPT Nozzle is designed specifically for NPT configuration fittings. The nozzles are machined to accommodate both male and female configurations, ensuring a perfect airtight seal every time.

The set of 7 nozzles consist of the following sizes: 1/4 in, 3/8 in, 1/2 in, 5/8 in, 3/4 in, 1 in and 1 1/4 in.

STAUFF Clean Projectiles

Coupling Series (SCP-C)

Intended for the cleaning of hose assemblies (hose with end fittings, adjustments, etc.) or the removal of loose contamination from pipe, tube or hose.



Abrasive Series (SCP-A)

Intended for the internal cleaning of metal pipe and tube to remove light contaminants (rust and scale). They are recognised by the shorter abrasive pad fixed to one end of the projectile.



Grinding Series (SCP-G)

Intended for the internal cleaning of metal pipe and tube to remove medium and heavy contamination (rust and scale) from the internal surface. They are recognised by the longer abrasive pad fixed to one end of the projectile that is coated in Silicon Carbide.



Size	Pipe / Tube / Hose ID		Ordering Codes		
	(mm)	(in)	Coupling Series (SCP-C)	Abrasive Series (SCP-A)	Grinding Series (SCP-G)
07	4,8	3/16	SCP-C-07	SCP-A-07	SCP-G-07
09	6,4	1/4	SCP-C-09	SCP-A-09	SCP-G-09
10	6,4	1/4	SCP-C-10	SCP-A-10	SCP-G-10
12	7,9	5/16	SCP-C-12	SCP-A-12	SCP-G-12
14	9,5	3/8	SCP-C-14	SCP-A-14	SCP-G-14
16	11,1	7/16	SCP-C-16	SCP-A-16	SCP-G-16
18	12,7	1/2	SCP-C-18	SCP-A-18	SCP-G-18
20	14,3	9/16	SCP-C-20	SCP-A-20	SCP-G-20
22	15,9	5/8	SCP-C-22	SCP-A-22	SCP-G-22
26	19,1	3/4	SCP-C-26	SCP-A-26	SCP-G-26
28	20,6	13/16	SCP-C-28	SCP-A-28	SCP-G-28
30	22,2	7/8	SCP-C-30	SCP-A-30	SCP-G-30
33	25,4	1	SCP-C-33	SCP-A-33	SCP-G-33
36	26 / 27	1 1/16	SCP-C-36	SCP-A-36	SCP-G-36
38	28,6	1 1/8	-	SCP-A-38	SCP-G-38
40	31,8	1 1/4	SCP-C-40	SCP-A-40	SCP-G-40
45	34,9	1 3/8	SCP-C-45	SCP-A-45	SCP-G-45
50	38,1	1 1/2	SCP-C-50	SCP-A-50	SCP-G-50
55	44,5	1 3/4	SCP-C-55	SCP-A-55	SCP-G-55
60	50,8	2	SCP-C-60	SCP-A-60	SCP-G-60

Please note: For optimum cleaning, it is recommended that projectiles are used once and then discarded and disposed of in an appropriate way.

Safety note: A mesh collection bag should be secured to the pipe, tube or hose exit to avoid possible injury to personnel by the projectile exiting at high velocity.

Always wear protective safety glasses, ear protection and a dust mask when operating this system.



Thread Identification Board Type FI-TIB

Product Description

The STAUFF Thread Identification Board is intended to be used as a universal tool for workshops, warehouses or sales counters allowing quick and easy determination of common thread types and sizes, e.g. for male stud tube connectors and test couplings.

The board is available in two different versions:

FI-TIB-M/G

13 Metric Parallel Threaded Ports

M8 x 1 / M10 x 1 / M12 x 1,5 / M14 x 1,5 /
M16 x 1,5 / M18 x 1,5 / M20 x 1,5 / M22 x 1,5 /
M26 x 1,5 / M27 x 2 / M33 x 2 / M42 x 2 / M48 x 2

8 Whitworth Parallel Pipe Threaded Ports

G1/8 / G1/4 / G3/8 / G1/2 / G3/4 / G1 / G1 1/4 / G1 1/2

FI-TIB-N/U

8 National Pipe Threaded Ports

1/8–27 NPT / 1/4–18 NPT / 3/8–18 NPT /
1/2–14 NPT / 3/4–14 NPT / 1–11.5 NPT /
1 1/4–11.5 NPT / 1 1/2–11.5 NPT

9 UNF/UN Threaded Ports

7/16–20 UNF / 1/2–20 UNF / 9/16–18 UNF /
3/4–16 UNF / 7/8–14 UNF / 1 1/16–12 UN /
1 5/16–12 UN / 1 5/8–12 UN / 1 7/8–12 UN



Product Features

- Covering all relevant thread type and sizes of male stud tube connectors and test couplings
- Boards made of hardened quality steel
- Finished with an extremely resistant cathodic electrodeposition coating
- Laser markings indicating the thread types and sizes next to the threaded ports
- Non-slip rubber feet providing good stability

Technical Data

- Dimensions (W x D x H): 275 mm x 190 mm x 31 mm
10.82 in x 7.48 in x 1.22 in
- Clearance height: 13 mm / .51 in
(height of the rubber feet)
- Weight: 6,0 kg / 13.2 lbs

Note

Thread identification boards are intended to be tools for the basic determination of thread types and sizes. They do not replace high-precision thread gauges and measurement devices (should these become necessary at any point).



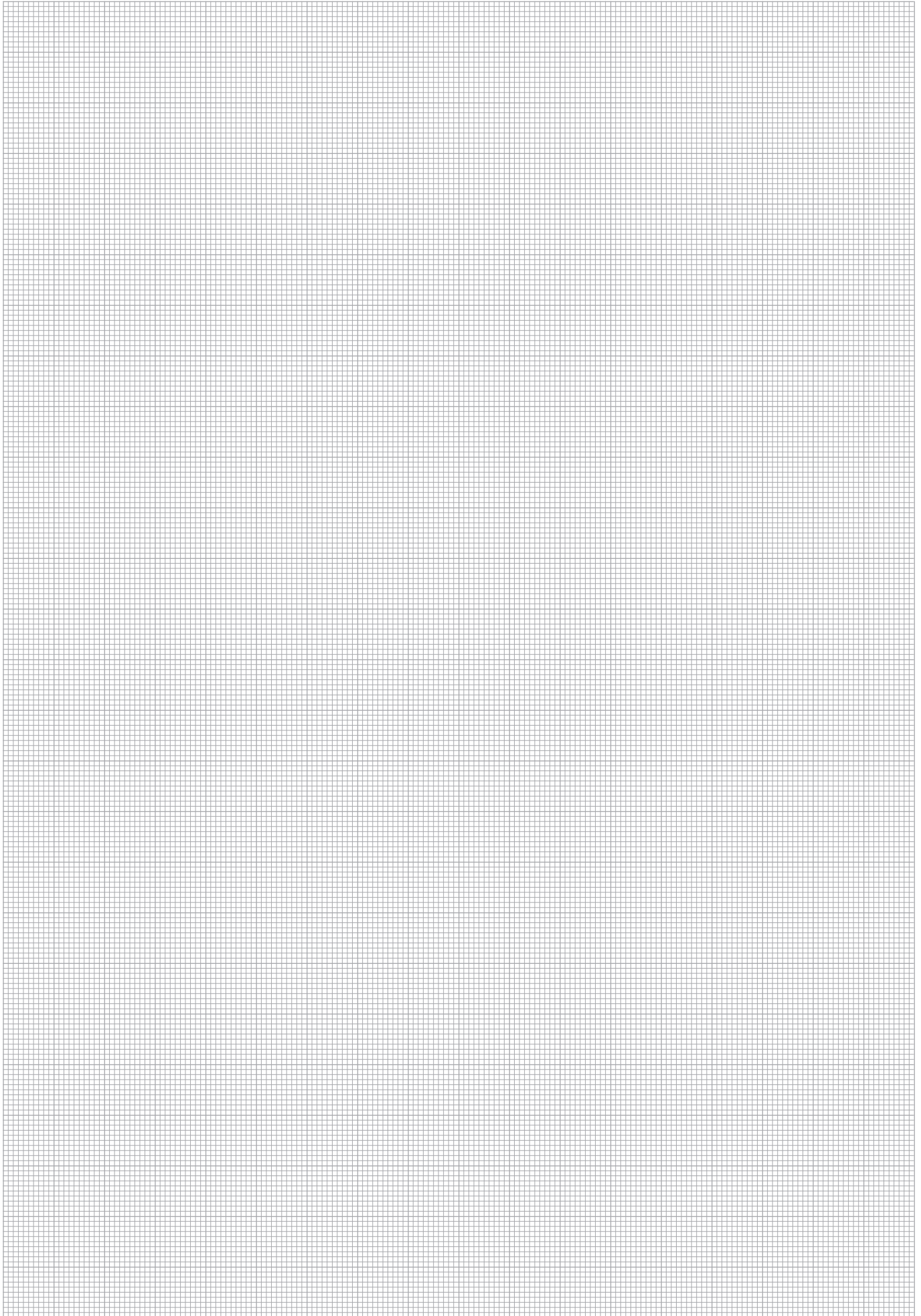

P



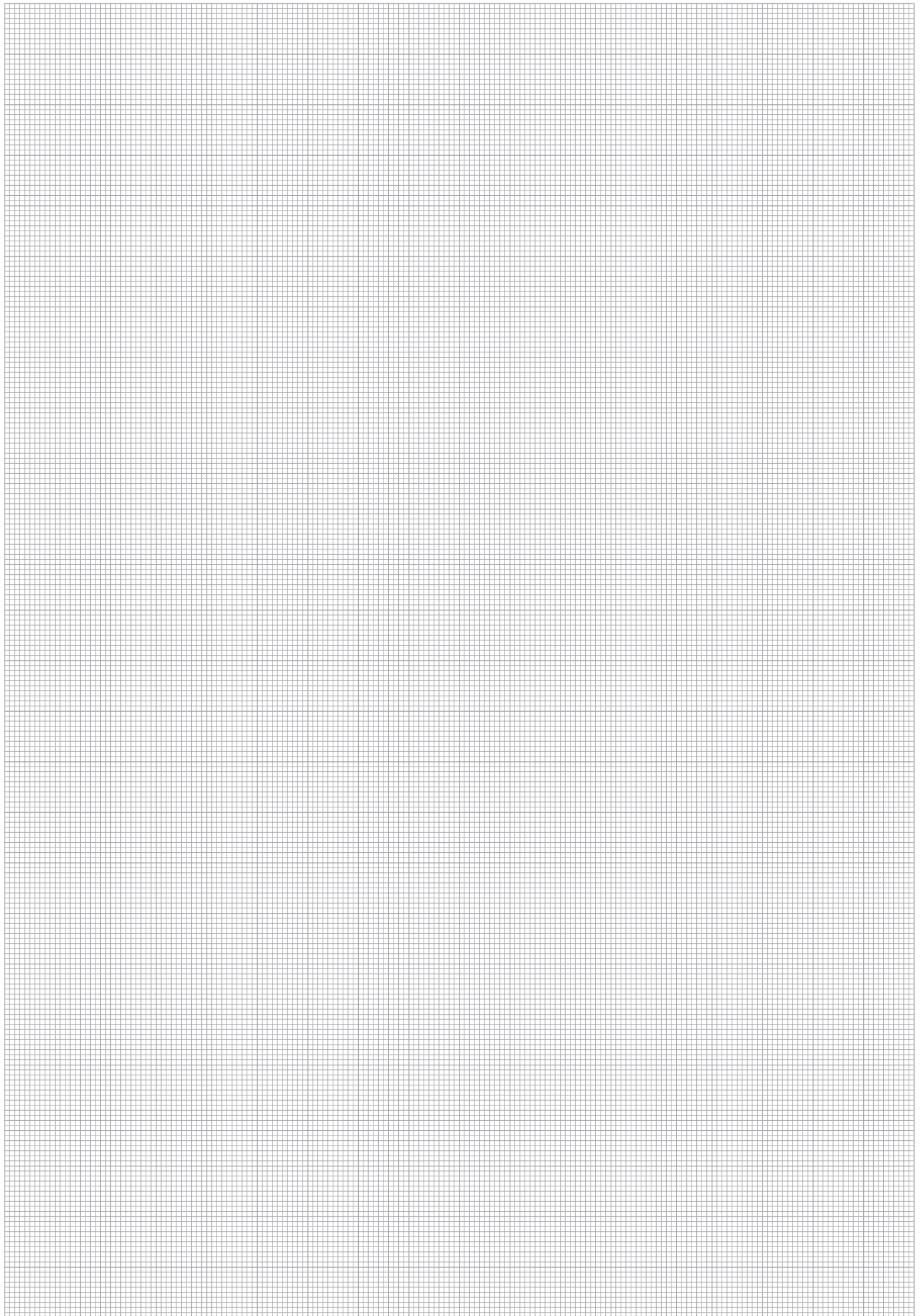

P



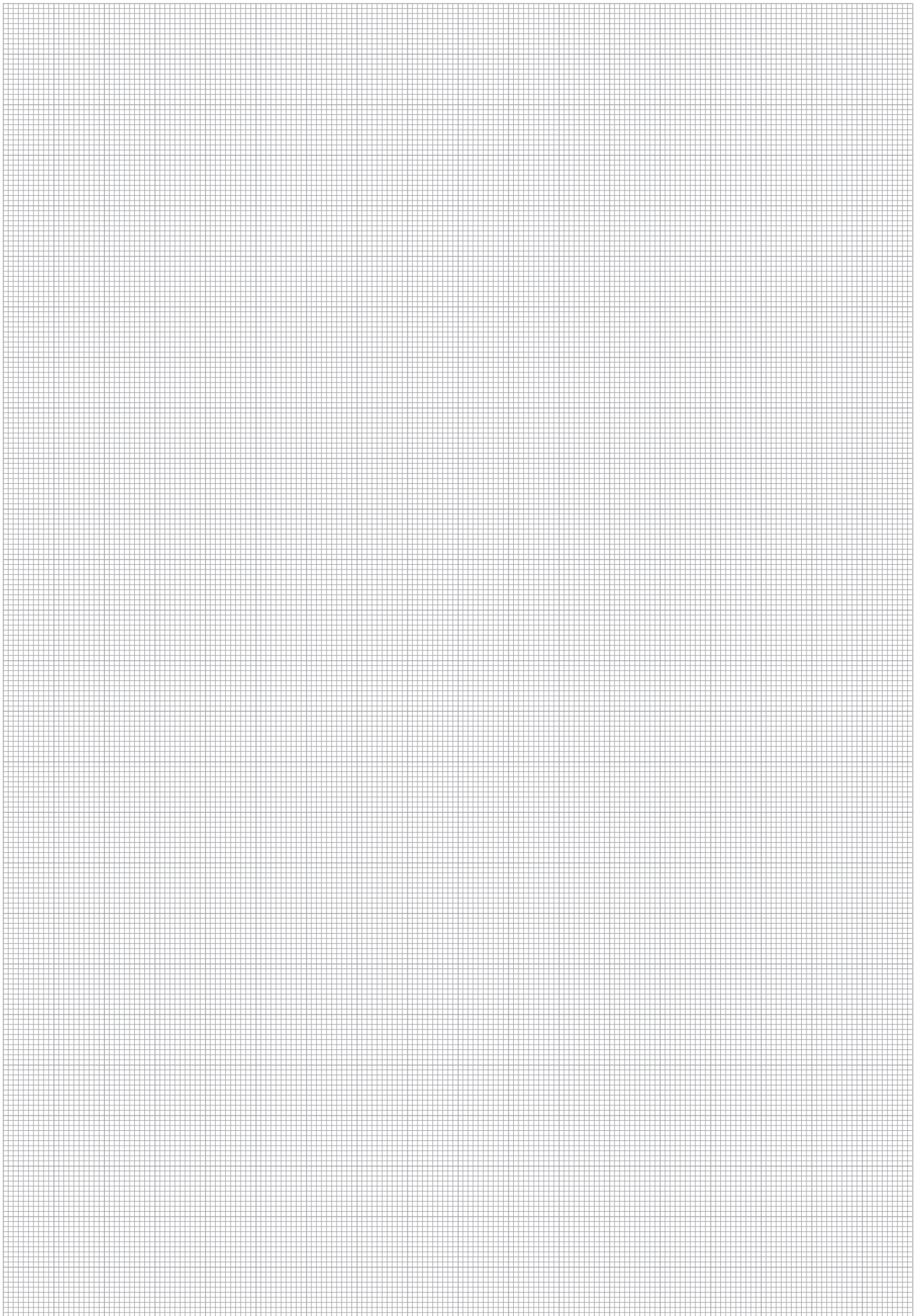

P





Assembly Instructions for STAUFF Connect 24° Tube Fittings with Double Edge Cutting Ring (Type FI-DS)	246-253
100% Assembly with the Manual Final Assembly Stud (Type FI-FK) and Assembly with the Fitting Body	246
50% Assembly with the Manual Pre-Assembly Stud (Type FI-VK) and Assembly with the Fitting Body	248
Direct Assembly with the Fitting Body	250
Machine-Assisted 100% Assembly with a STAUFF Press Assembly Machine and Assembly with the Fitting Body	252
Machine-Assisted 50% Assembly with a STAUFF Press Assembly Machine and Assembly with the Fitting Body	253
Assembly Instructions for STAUFF Connect 24° Tube Fittings with Soft-Sealing Cutting Ring (Type FI-WDDS)	254-261
100% Assembly with the Manual Final Assembly Stud (Type FI-FK) and Assembly with the Fitting Body	254
50% Assembly with the Manual Pre-Assembly Stud (Type FI-VK) and Assembly with the Fitting Body	256
Direct Assembly with the Fitting Body	258
Machine-Assisted 100% Assembly with a STAUFF Press Assembly Machine and Assembly with the Fitting Body	260
Machine-Assisted 50% Assembly with a STAUFF Press Assembly Machine and Assembly with the Fitting Body	261
Assembly Instructions for Support Sleeves	262
Assembly Instructions for STAUFF Form Tube Fittings	264
Assembly Instructions for STAUFF Connect 37° Flared Tube Fittings	268
Assembly Instructions for 24° Weld Cones with O-Ring	272
Assembly Instructions for Tube Fittings with 24° Taper and O-Ring	274
Assembly Instructions for Tube Fittings with Standpipe	274
Assembly Instructions for Tube Fittings with Male Threaded Stud	275
Assembly Instructions for Banjo Fittings	276



Assembly Instructions for STAUFF Connect 24° Tube Fittings with Double Edge Cutting Ring (Type FI-DS)

100% Assembly with the Manual Final Assembly Stud (Type FI-FK) and Assembly with the Fitting Body

1. Tube Preparation

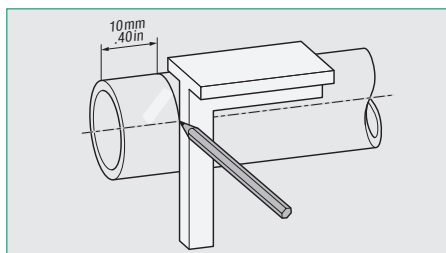

Saw off tube in right angle and at least 10 mm / .40 in from the cut made by the tube manufacturer / supplier in order to avoid failures caused during shipment.

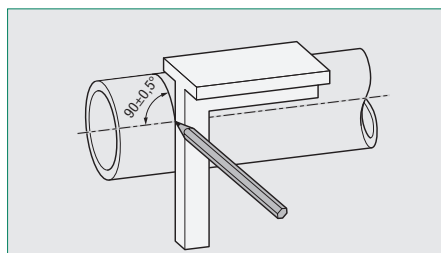

A maximum angular deviation / tolerance of $\pm 0,5^\circ$ relative to the tube axis is permissible.

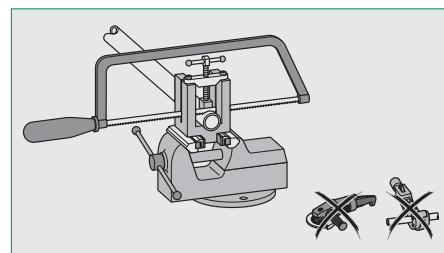

Only use proper tube sawing machinery or equipment. Do not use tube cutters or grinders as this may result in unwanted angled cuts and cause severe burring.

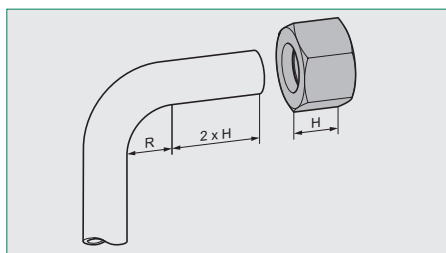

For tube bends, the length of the straight section of the tube end to the start of the bending radius has to be twice the height of the union nut.

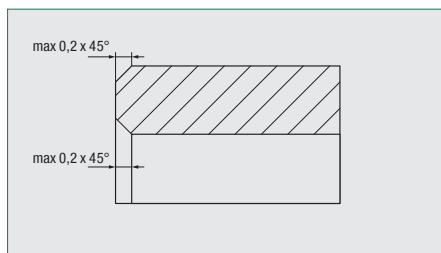

Slightly deburr inside and outside of the tube end (max 0,2 x 45°). The assembly area of the tube has to be free of contamination, chips and paint.

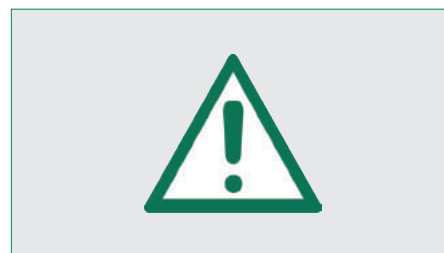

Please note: Improperly prepared and contaminated tubes will affect the service life of the connection and may result in leakage.

2. Assembly Preparation

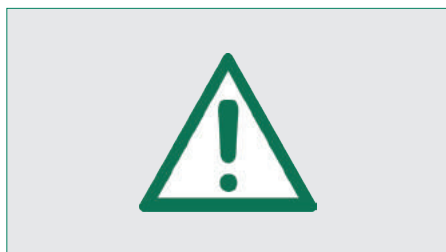

Please note: Hardened final assembly studs are wear-resistant, thus allowing for consistent assembly results with a maximum degree of accuracy, reliability and process stability.

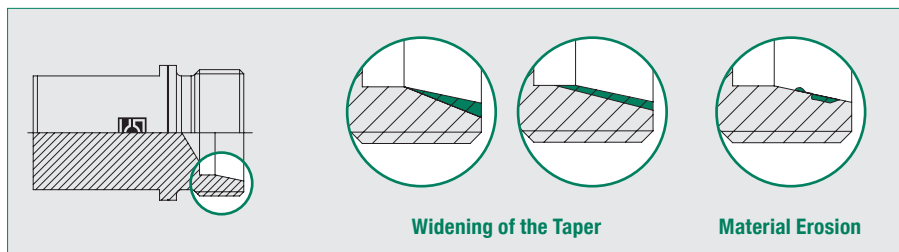

However, they have to be checked for dimensional accuracy regularly. Assembly studs that are damaged and/or dimensionally not accurate must be replaced under any circumstances!

Typical damages include widening of the 24° angle or the entire taper, as well as material erosion.

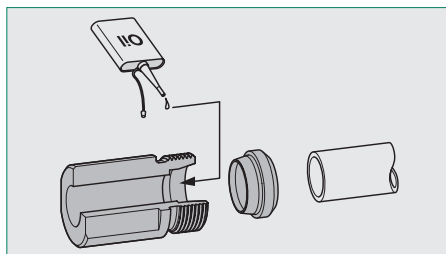

Lightly lubricate the 24° taper of the final assembly stud (e.g. using mineral-oil based hydraulic fluid HLP32). Do not use lubricating grease!

Immediately proceed with the assembly in order to avoid exposure to contamination.

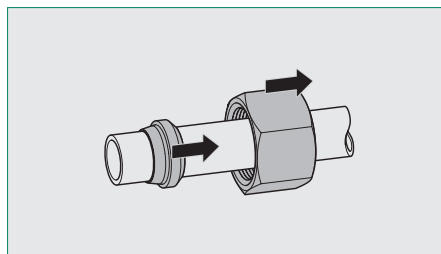

Consecutively put the union nut first and then the cutting ring onto the tube end.

Pay attention to the correct alignment of the cutting ring: The cutting edges have to face to the tube end.

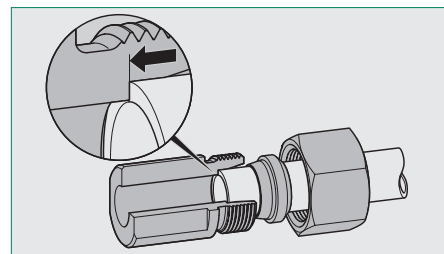

Carefully insert the tube end into the 24° taper of the final assembly stud and push it firmly against the inner stop.

The tube must be held in this position during the entire assembly process in order to avoid faulty assembly.

Q



Assembly Instructions for STAUFF Connect 24° Tube Fittings with Double Edge Cutting Ring (Type FI-DS)

100% Assembly with the Manual Final Assembly Stud (Type FI-FK) and Assembly with the Fitting Body

3. Assembly in the Assembly Stud

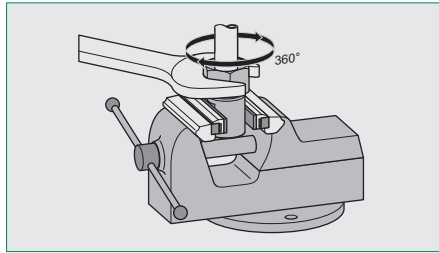
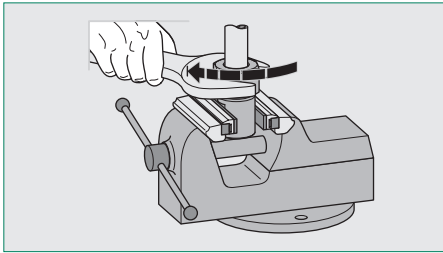

Tighten the union nut until the noticeable increase in force (pressure point). The cutting ring now grips the tube, which can no longer be rotated.

Use a suitable spanner to tighten the union nut another full turn (360°) beyond the pressure point. In doing so, the cutting ring will uniformly cut into the tube.

4. Inspection

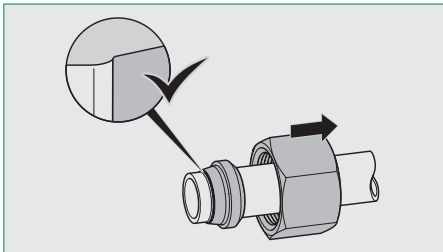

Fully untighten the union nut for a visual inspection after the assembly. A raise of tube material must be clearly visible in front of the cutting edge.

In this position, it is still permissible for the cutting ring to turn on the tube, but not to be displaced in axial direction of the tube.

Please note: If not enough tube material has been raised in front of the cutting edge or if the cutting ring is still capable of being displaced in axial direction, the assembly procedure must be repeated by using more force, and the result must be re-checked.

5. Assembly with the Fitting Body

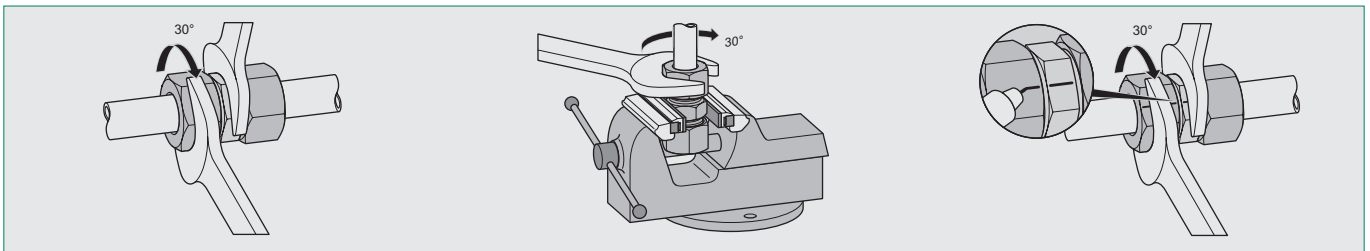

Carefully insert the assembled tube end into the 24° taper of the fitting body.

Use a suitable spanner to tighten the union nut until the noticeable increase in force, and then finish the assembly with another approximately 1/12 a turn (30°) beyond this point.

Always use a second spanner to hold the fitting body during the entire assembly procedure.

In case of unfavourable mounting conditions or larger tube dimensions, use a bench vice for the assembly.

A marking line applied on the union nut and the fitting body makes it easier to indicate the sufficient tightening angle.

6. Repeated Assembly

For repeated assemblies, please use a suitable spanner to tighten the union nut until the noticeable increase in force, and then finish the assembly with another approximately 1/12 a turn (30°) beyond this point.



Assembly Instructions for STAUFF Connect 24° Tube Fittings with Double Edge Cutting Ring (Type FI-DS)

50% Assembly with the Manual Pre-Assembly Stud (Type FI-VK) and Assembly with the Fitting Body

1. Tube Preparation

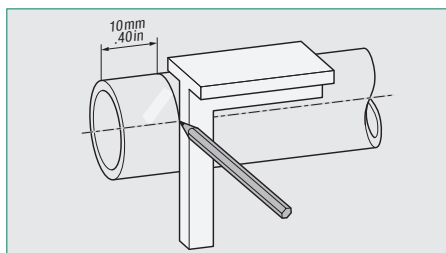

Saw off tube in right angle and at least 10 mm / .40 in from the cut made by the tube manufacturer / supplier in order to avoid failures caused during shipment.

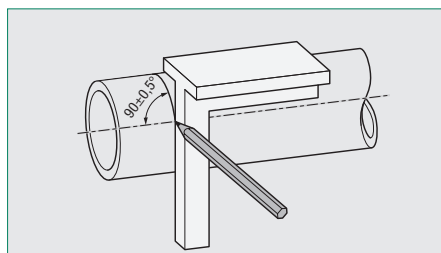

A maximum angular deviation / tolerance of $\pm 0,5^\circ$ relative to the tube axis is permissible.

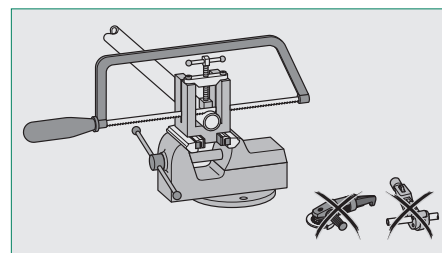

Only use proper tube sawing machinery or equipment. Do not use tube cutters or grinders as this may result in unwanted angled cuts and cause severe burring.

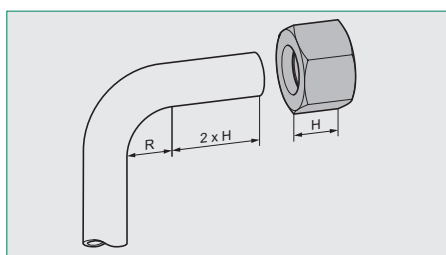

For tube bends, the length of the straight section of the tube end to the start of the bending radius has to be twice the height of the union nut.

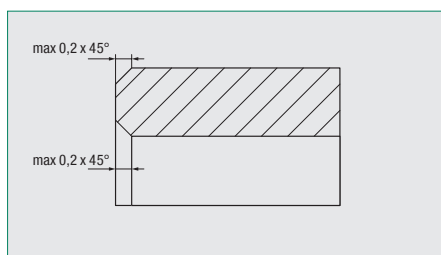

Slightly deburr inside and outside of the tube end (max 0,2 x 45°). The assembly area of the tube has to be free of contamination, chips and paint.

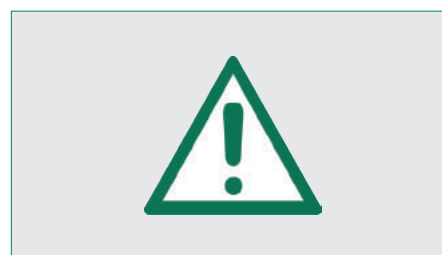

Please note: Improperly prepared and contaminated tubes will affect the service life of the connection and may result in leakage.

2. Assembly Preparation

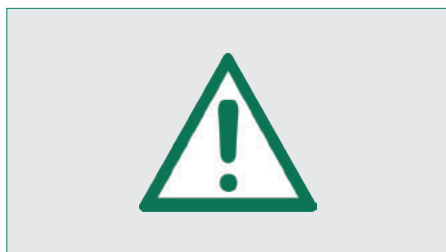

Please note: Hardened pre-assembly studs are wear-resistant, thus allowing for consistent assembly results with a maximum degree of accuracy, reliability and process stability.

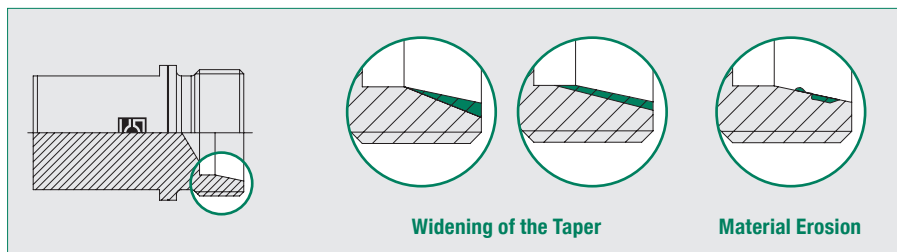

However, they have to be checked for dimensional accuracy regularly. Assembly studs that are damaged and/or dimensionally not accurate must be replaced under any circumstances!

Typical damages include widening of the 24° angle or the entire taper, as well as material erosion.

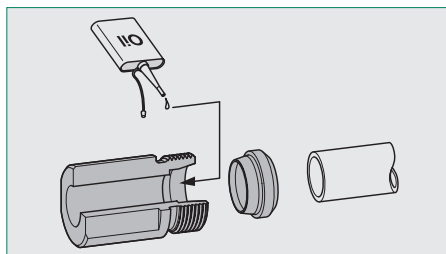

Lightly lubricate the 24° taper of the pre-assembly stud (e.g. using mineral-oil based hydraulic fluid HLP32). Do not use lubricating grease!

Immediately proceed with the assembly in order to avoid exposure to contamination.

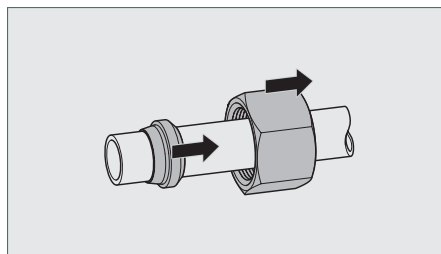

Consecutively put the union nut first and then the cutting ring onto the tube end.

Pay attention to the correct alignment of the cutting ring: The cutting edges have to face to the tube end.

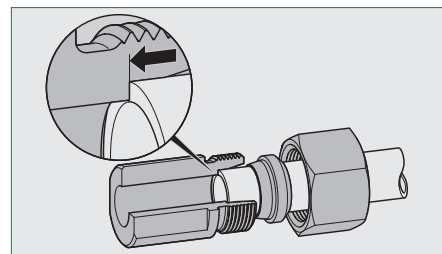

Carefully insert the tube end into the 24° taper of the pre-assembly stud and push it firmly against the inner stop.

The tube must be held in this position during the entire assembly process in order to avoid faulty assembly.

Q



Assembly Instructions for STAUFF Connect 24° Tube Fittings with Double Edge Cutting Ring (Type FI-DS)

50% Assembly with the Manual Pre-Assembly Stud (Type FI-VK) and Assembly with the Fitting Body

3. Assembly in the Assembly Stud

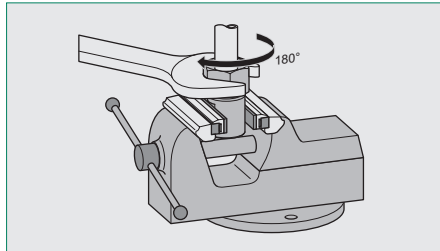
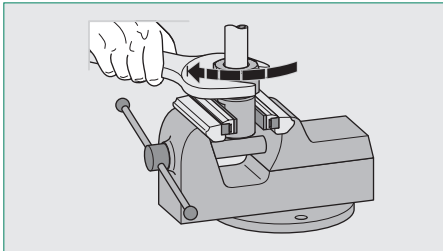

Tighten the union nut until the noticeable increase in force (pressure point). The cutting ring now grips the tube, which can no longer be rotated.

Use a suitable spanner to tighten the union nut another 1/2 a turn (180°) beyond the pressure point. In doing so, the cutting ring will uniformly cut into the tube.

4. Assembly with the Fitting Body

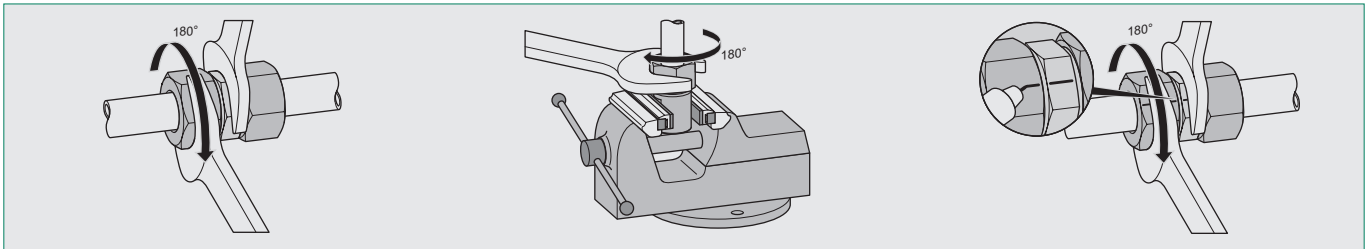

Carefully insert the assembled tube end into the 24° taper of the fitting body.

Use a suitable spanner to tighten the union nut until the noticeable increase in force, and then finish the assembly with another approximately 1/2 a turn (180°) beyond this point.

Always use a second spanner to hold the fitting body during the entire assembly procedure.

In case of unfavourable mounting conditions or larger tube dimensions, use a bench vice for the assembly.

A marking line applied on the union nut and the fitting body makes it easier to indicate the sufficient tightening angle.

5. Inspection

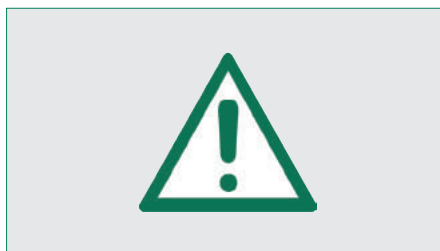
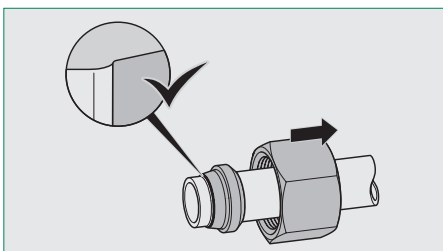

Fully untighten the union nut for a visual inspection after the assembly. A raise of tube material must be clearly visible in front of the cutting edge.

In this position, it is still permissible for the cutting ring to turn on the tube, but not to be displaced in axial direction of the tube.

Please note: If not enough tube material has been raised in front of the cutting edge or if the cutting ring is still capable of being displaced in axial direction, the assembly procedure must be repeated by using more force, and the result must be re-checked.

6. Repeated Assembly

For repeated assemblies, please use a suitable spanner to tighten the union nut until the noticeable increase in force, and then finish the assembly with another approximately 1/12 a turn (30°) beyond this point.



Assembly Instructions for STAUFF Connect 24° Tube Fittings with Double Edge Cutting Ring (Type FI-DS) Direct Assembly with the Fitting Body

1. Tube Preparation

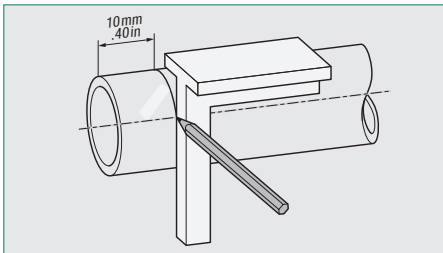

Saw off tube in right angle and at least 10 mm / .40 in from the cut made by the tube manufacturer / supplier in order to avoid failures caused during shipment.

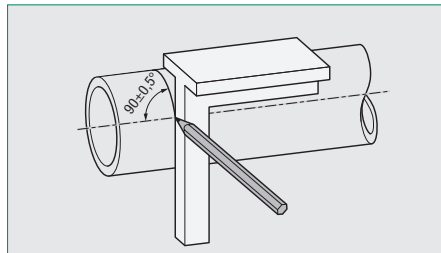

A maximum angular deviation / tolerance of $\pm 0,5^\circ$ relative to the tube axis is permissible.

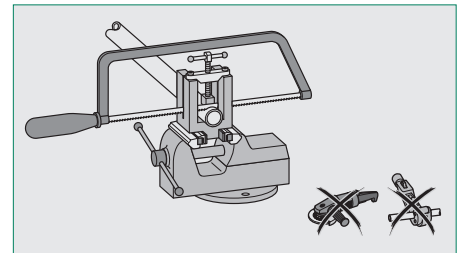

Only use proper tube sawing machinery or equipment. Do not use tube cutters or grinders as this may result in unwanted angled cuts and cause severe burring.

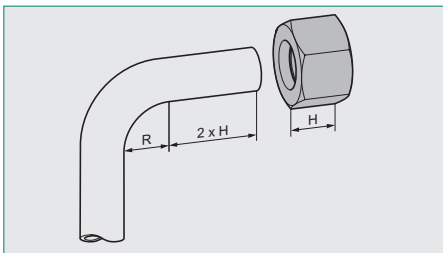

For tube bends, the length of the straight section of the tube end to the start of the bending radius has to be twice the height of the union nut.

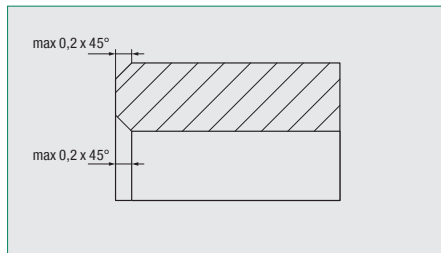

Slightly deburr inside and outside of the tube end (max 0,2 x 45°). The assembly area of the tube has to be free of contamination, chips and paint.

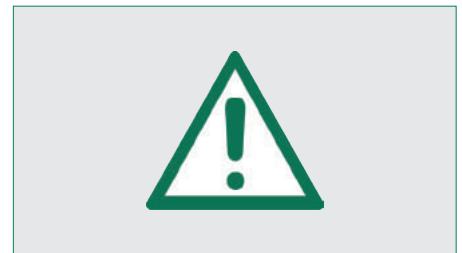

Please note: Improperly prepared and contaminated tubes will affect the service life of the connection and may result in leakage.

2. Assembly Preparation

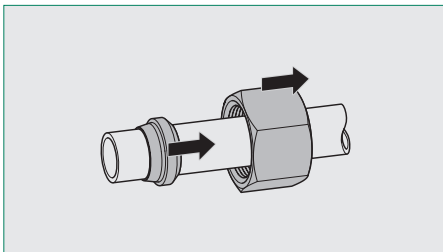

Consecutively put the union nut first and then the cutting ring onto the tube end.

Pay attention to the correct alignment of the cutting ring: The cutting edges have to face to the tube end.

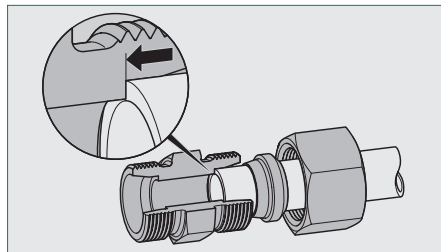

Carefully insert the tube end into the 24° taper of the fitting body and push it firmly against the inner stop.

The tube must be held in this position during the entire assembly process in order to avoid faulty assembly.



Assembly Instructions for STAUFF Connect 24° Tube Fittings with Double Edge Cutting Ring (Type FI-DS) Direct Assembly with the Fitting Body

3. Assembly in the Fitting Body

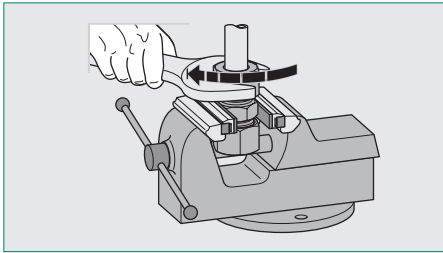

Tighten the union nut until the noticeable increase in force (pressure point). The cutting ring now grips the tube, which can no longer be rotated.

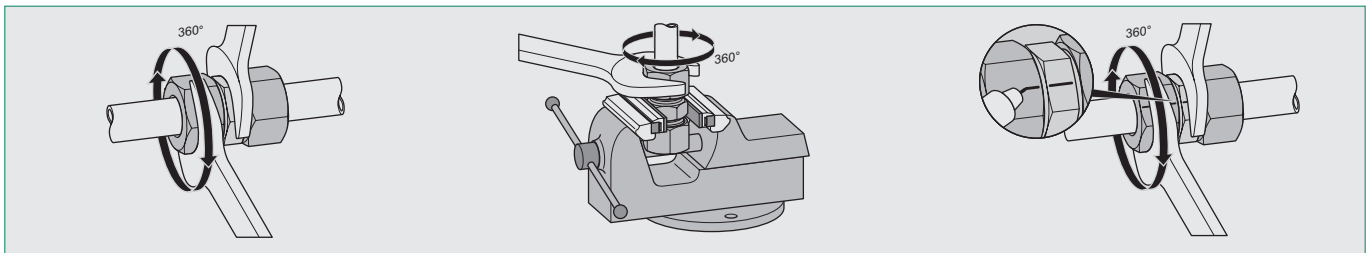

Use a suitable spanner to tighten the union nut another full turn (360°) beyond the pressure point. In doing so, the cutting ring will uniformly cut into the tube.

Always use a second spanner to hold the fitting body during the entire assembly procedure.

In case of unfavourable mounting conditions or larger tube dimensions, use a bench vice for the assembly.

A marking line applied on the union nut and the fitting body makes it easier to indicate the sufficient tightening angle.

4. Inspection

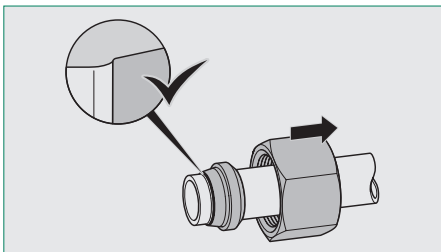

Fully untighten the union nut for a visual inspection after the assembly. A raise of tube material must be clearly visible in front of the cutting edge.

In this position, it is still permissible for the cutting ring to turn on the tube, but not to be displaced in axial direction of the tube.

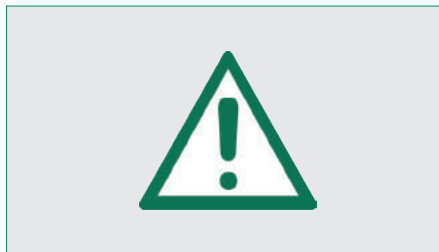

Please note: If not enough tube material has been raised in front of the cutting edge or if the cutting ring is still capable of being displaced in axial direction, the assembly procedure must be repeated by using more force, and the result must be re-checked.

5. Repeated Assembly

For repeated assemblies, please use a suitable spanner to tighten the union nut until the noticeable increase in force, and then finish the assembly with another approximately 1/12 a turn (30°) beyond this point.



Assembly Instructions for STAUFF Connect 24° Tube Fittings with Double Edge Cutting Ring (Type FI-DS)

Machine-Assisted 100% Assembly with a STAUFF Press Assembly Machine and Assembly with the Fitting Body

1. Tube Preparation

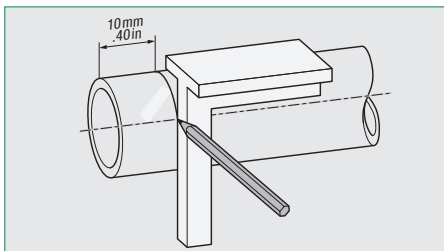

Saw off tube in right angle and at least 10 mm / .40 in from the cut made by the tube manufacturer / supplier in order to avoid failures caused during shipment.

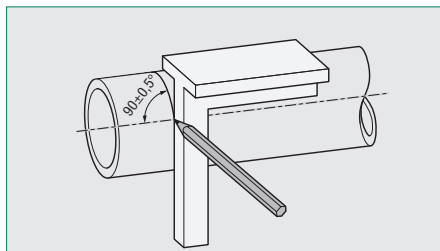

A maximum angular deviation / tolerance of $\pm 0,5^\circ$ relative to the tube axis is permissible.

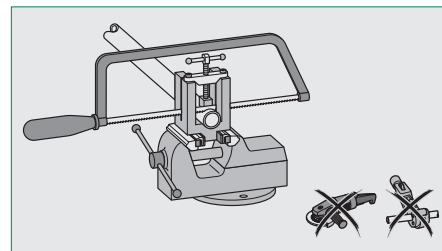

Only use proper tube sawing machinery or equipment. Do not use tube cutters or grinders as this may result in unwanted angled cuts and cause severe burring.

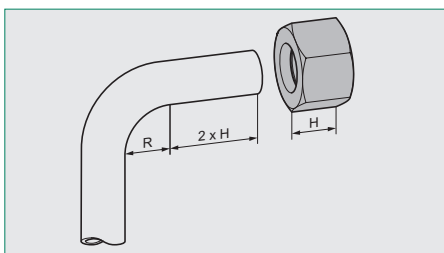

For tube bends, the length of the straight section of the tube end to the start of the bending radius has to be twice the height of the union nut.

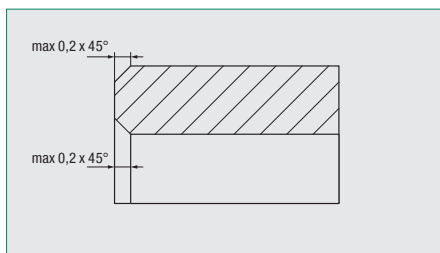

Slightly deburr inside and outside of the tube end (max $0,2 \times 45^\circ$). The assembly area of the tube has to be free of contamination, chips and paint.

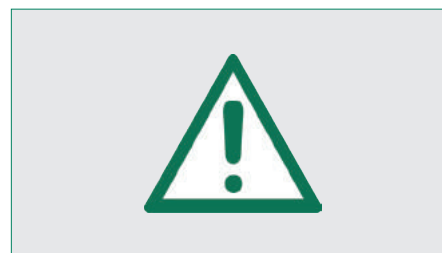

Please note: Improperly prepared and contaminated tubes will affect the service life of the connection and may result in leakage.

2. Assembly Preparation, Machine-Assisted Assembly and Inspection

With regards to assembly preparation, the actual assembly as well as the inspection of assembled tube ends, please follow the detailed instructions in the operating manual of the machine.



3. Assembly with the Fitting Body

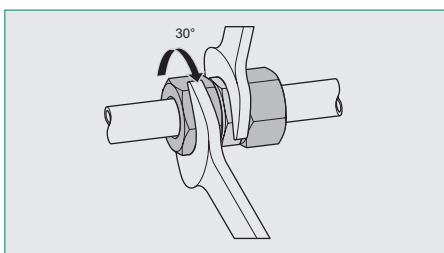

Carefully insert the assembled tube end into the 24° taper of the fitting body.

Use a suitable spanner to tighten the union nut until the noticeable increase in force, and then finish the assembly with another approximately $1/12$ a turn (30°) beyond this point.

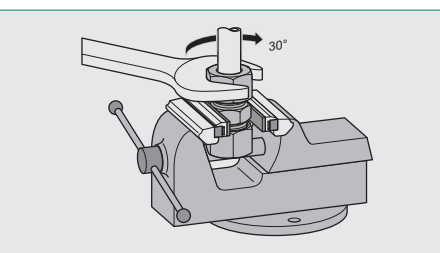

Always use a second spanner to hold the fitting body during the entire assembly procedure.

In case of unfavourable mounting conditions or larger tube dimensions, use a bench vice for the assembly.

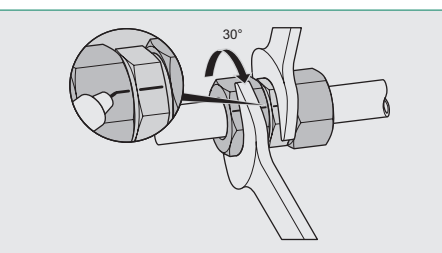

A marking line applied on the union nut and the fitting body makes it easier to indicate the sufficient tightening angle.

4. Repeated Assembly

For repeated assemblies, please use a suitable spanner to tighten the union nut until the noticeable increase in force, and then finish the assembly with another approximately $1/12$ a turn (30°) beyond this point.

Q



Assembly Instructions for STAUFF Connect 24° Tube Fittings with Double Edge Cutting Ring (Type FI-DS)

Machine-Assisted 50% Assembly with a STAUFF Press Assembly Machine and Assembly with the Fitting Body

1. Tube Preparation

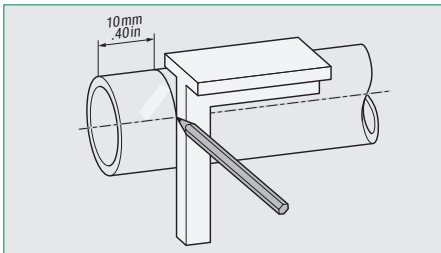

Saw off tube in right angle and at least 10 mm / .40 in from the cut made by the tube manufacturer / supplier in order to avoid failures caused during shipment.

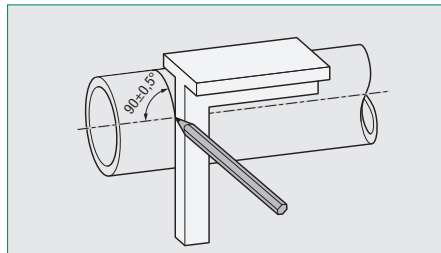

A maximum angular deviation / tolerance of $\pm 0,5^\circ$ relative to the tube axis is permissible.

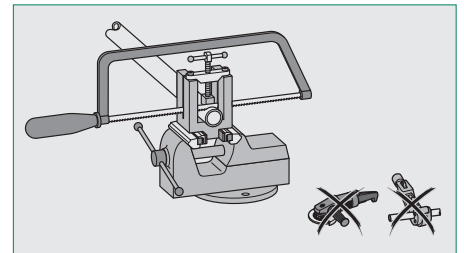

Only use proper tube sawing machinery or equipment. Do not use tube cutters or grinders as this may result in unwanted angled cuts and cause severe burring.

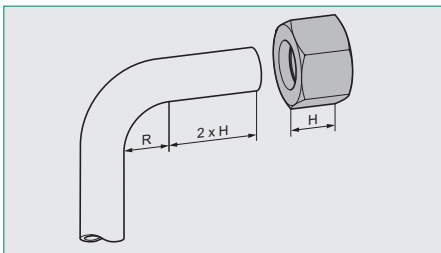

For tube bends, the length of the straight section of the tube end to the start of the bending radius has to be twice the height of the union nut.

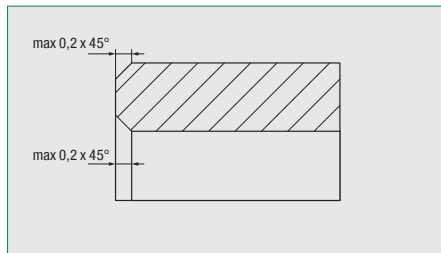

Slightly deburr inside and outside of the tube end (max $0,2 \times 45^\circ$). The assembly area of the tube has to be free of contamination, chips and paint.

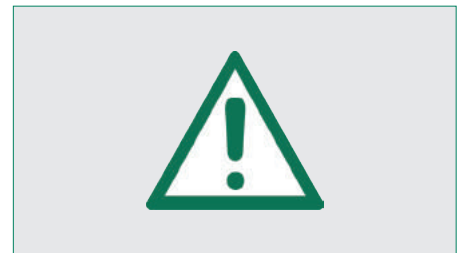

Please note: Improperly prepared and contaminated tubes will affect the service life of the connection and may result in leakage.

2. Assembly Preparation, Machine-Assisted Assembly and Inspection

With regards to assembly preparation, the actual assembly as well as the inspection of assembled tube ends, please follow the detailed instructions in the operating manual of the machine.



3. Assembly with the Fitting Body

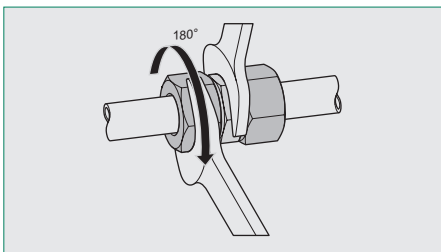

Carefully insert the assembled tube end into the 24° taper of the fitting body.

Use a suitable spanner to tighten the union nut until the noticeable increase in force, and then finish the assembly with another approximately 1/2 a turn (180°) beyond this point.

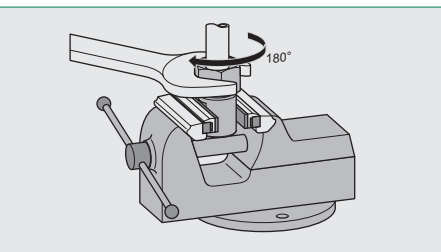

Always use a second spanner to hold the fitting body during the entire assembly procedure.

In case of unfavourable mounting conditions or larger tube dimensions, use a bench vice for the assembly.

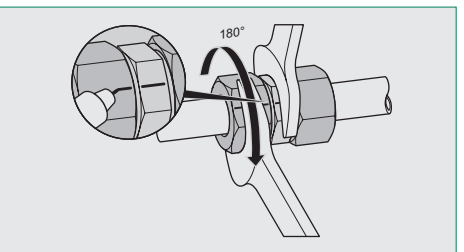

A marking line applied on the union nut and the fitting body makes it easier to indicate the sufficient tightening angle.

4. Repeated Assembly

For repeated assemblies, please use a suitable spanner to tighten the union nut until the noticeable increase in force, and then finish the assembly with another approximately 1/12 a turn (30°) beyond this point.



Assembly Instructions for STAUFF Connect 24° Tube Fittings with Soft-Sealing Cutting Ring (Type FI-WDDS) 100% Assembly with the Manual Final Assembly Stud (Type FI-FK) and Assembly with the Fitting Body

1. Tube Preparation

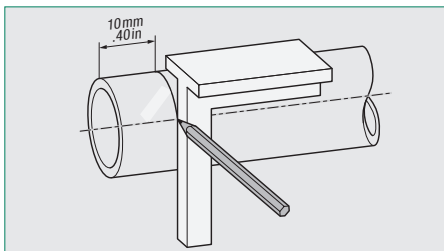

Saw off tube in right angle and at least 10 mm / .40 in from the cut made by the tube manufacturer / supplier in order to avoid failures caused during shipment.

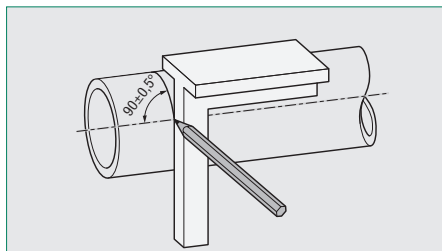

A maximum angular deviation / tolerance of $\pm 0,5^\circ$ relative to the tube axis is permissible.

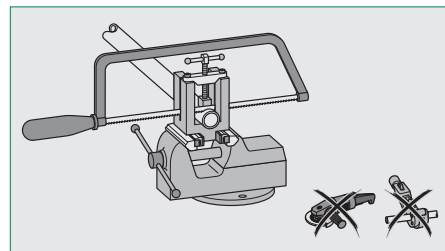

Only use proper tube sawing machinery or equipment. Do not use tube cutters or grinders as this may result in unwanted angled cuts and cause severe burring.

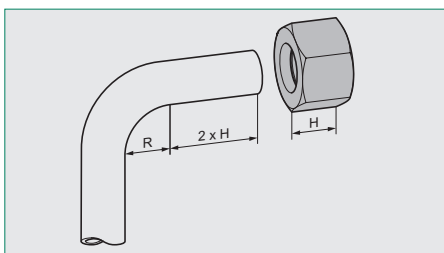

For tube bends, the length of the straight section of the tube end to the start of the bending radius has to be twice the height of the union nut.

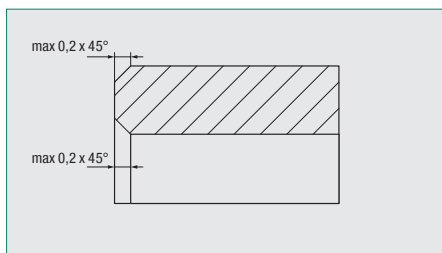

Slightly deburr inside and outside of the tube end (max 0,2 x 45°). The assembly area of the tube has to be free of contamination, chips and paint.

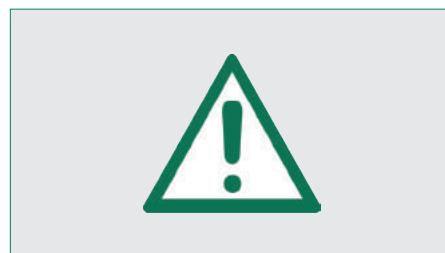

Please note: Improperly prepared and contaminated tubes will affect the service life of the connection and may result in leakage.

2. Assembly Preparation

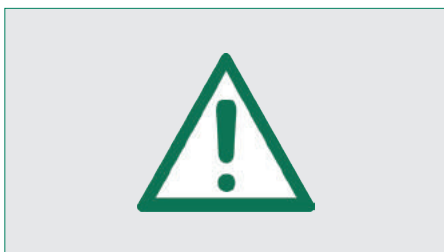

Please note: Hardened assembly studs are wear-resistant, thus allowing for consistent assembly results with a maximum degree of accuracy, reliability and process stability.

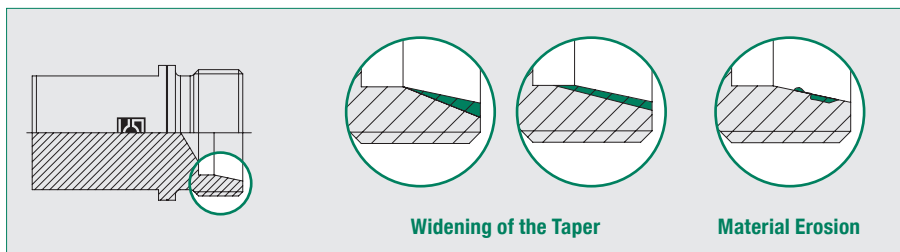

However, they have to be checked for dimensional accuracy regularly. Assembly studs that are damaged and/or dimensionally not accurate must be replaced under any circumstances!

Typical damages include widening of the 24° angle or the entire taper, as well as material erosion.

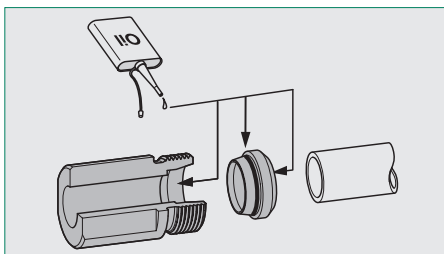

Lightly lubricate the 24° taper of the assembly stud as well as the two soft-sealing elements of the cutting ring (e.g. using mineral-oil based hydraulic fluid HLP32). Do not use lubricating grease!

Immediately proceed with the assembly in order to avoid exposure to contamination.

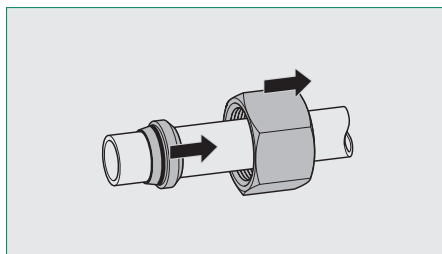

Consecutively put the union nut first and then the cutting ring onto the tube end.

Pay attention to the correct alignment of the cutting ring: The cutting edges have to face to the tube end.

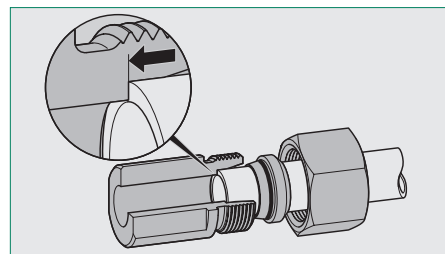

Carefully insert the tube end into the 24° taper of the final assembly stud and push it firmly against the inner stop.

The tube must be held in this position during the entire assembly process in order to avoid faulty assembly.

Q



Assembly Instructions for STAUFF Connect 24° Tube Fittings with Soft-Sealing Cutting Ring (Type FI-WDDS)

100% Assembly with the Manual Final Assembly Stud (Type FI-FK) and Assembly with the Fitting Body

3. Assembly in the Assembly Stud

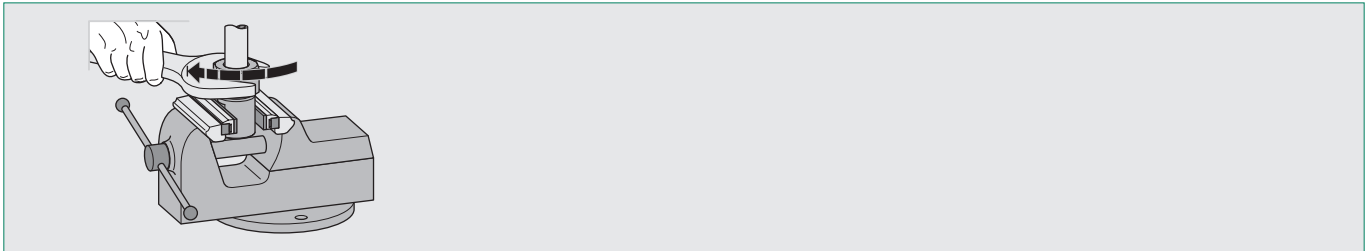

Use a suitable spanner to tighten the union nut until the point where the cutting ring comes into contact and sits closely with the face side of the fitting body, and pretension it.

This point is characterised by a significant increase in force and typically situated 1 to 1 1/2 turns (360° to 540°) beyond the pressure point.

At this point, the cutting ring starts gripping the tube, which can no longer be rotated.

4. Inspection

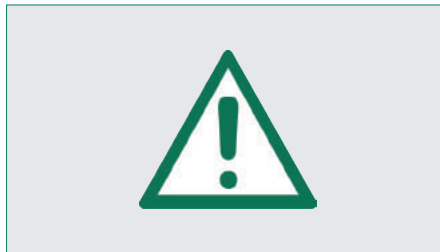
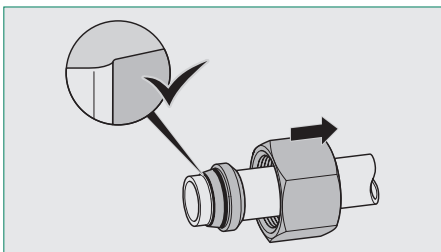

Fully untighten the union nut for a visual inspection after the assembly. A raise of tube material must be clearly visible in front of the cutting edge.

In this position, it is still permissible for the cutting ring to turn on the tube, but not to be displaced in axial direction of the tube.

Please note: If not enough tube material has been raised in front of the cutting edge or if the cutting ring is still capable of being displaced in axial direction, the assembly procedure must be repeated by using more force, and the result must be re-checked.

5. Assembly with the Fitting Body

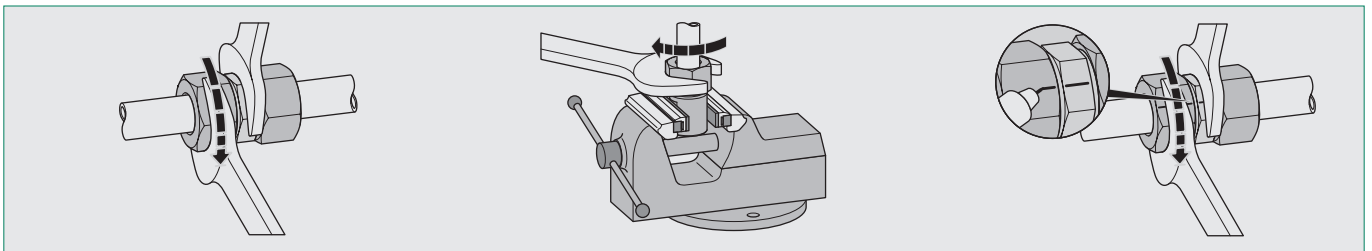

Lightly lubricate the soft-sealing element located on the 24° taper of the cutting ring (e.g. using mineral-oil based hydraulic fluid HLP32). Do not use lubricating grease!

Immediately proceed with the assembly in order to avoid exposure to contamination.

Carefully insert the assembled tube end into the 24° taper of the fitting body.

Use a suitable spanner to tighten the union nut until the point where the cutting ring comes into contact and sits closely with the face side of the fitting body, and pretension it. This point is characterised by a significant increase in force.

Always use a second spanner to hold the fitting body during the entire assembly procedure.

In case of unfavourable mounting conditions or larger tube dimensions, use a bench vice for the assembly.

A marking line applied on the union nut and the fitting body makes it easier to indicate the sufficient tightening angle.

6. Repeated Assembly

Check the soft-sealing element located on the 24° taper of the cutting ring for possible damages.

Use a suitable spanner to tighten the union nut until the point where the cutting ring comes into contact and sits closely with the face side of the fitting body, and pretension it. This point is characterised by a significant increase in force.



Assembly Instructions for STAUFF Connect 24° Tube Fittings with Soft-Sealing Cutting Ring (Type FI-WDDS) 50% Assembly with the Manual Pre-Assembly Stud (Type FI-VK) and Assembly with the Fitting Body

1. Tube Preparation

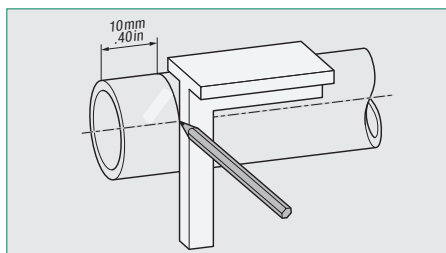

Saw off tube in right angle and at least 10 mm / .40 in from the cut made by the tube manufacturer / supplier in order to avoid failures caused during shipment.

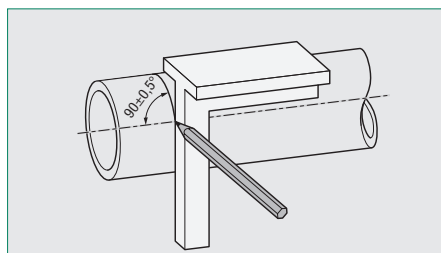

A maximum angular deviation / tolerance of $\pm 0,5^\circ$ relative to the tube axis is permissible.

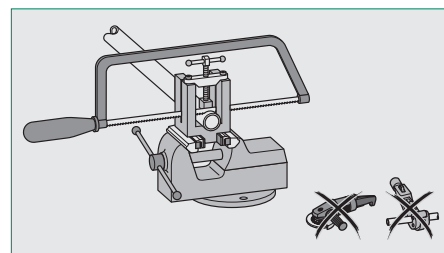

Only use proper tube sawing machinery or equipment. Do not use tube cutters or grinders as this may result in unwanted angled cuts and cause severe burring.

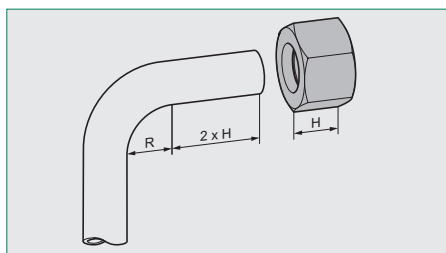

For tube bends, the length of the straight section of the tube end to the start of the bending radius has to be twice the height of the union nut.

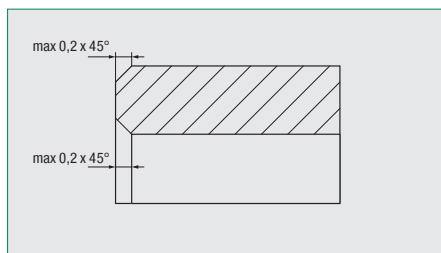

Slightly deburr inside and outside of the tube end (max 0,2 x 45°). The assembly area of the tube has to be free of contamination, chips and paint.

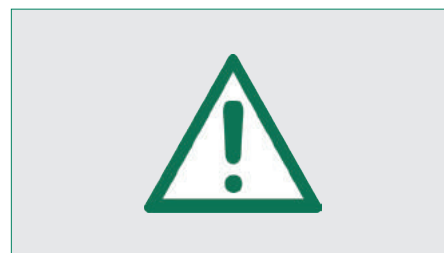

Please note: Improperly prepared and contaminated tubes will affect the service life of the connection and may result in leakage.

2. Assembly Preparation

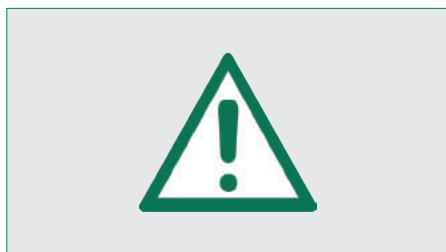

Please note: Hardened assembly studs are wear-resistant, thus allowing for consistent assembly results with a maximum degree of accuracy, reliability and process stability.

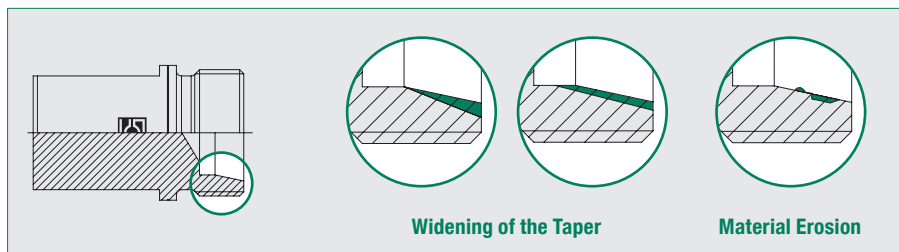

However, they have to be checked for dimensional accuracy regularly. Assembly studs that are damaged and/or dimensionally not accurate must be replaced under any circumstances!

Typical damages include widening of the 24° angle or the entire taper, as well as material erosion.

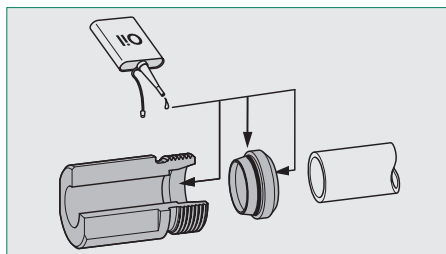

Lightly lubricate the 24° taper of the assembly stud as well as the two soft-sealing elements of the cutting ring (e.g. using mineral-oil based hydraulic fluid HLP32). Do not use lubricating grease!

Immediately proceed with the assembly in order to avoid exposure to contamination.

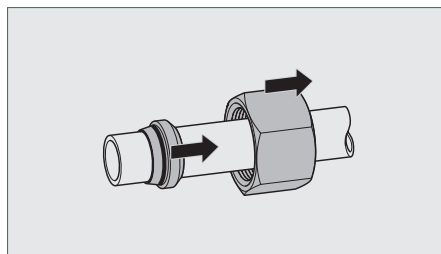

Consecutively put the union nut first and then the cutting ring onto the tube end.

Pay attention to the correct alignment of the cutting ring: The cutting edges have to face to the tube end.

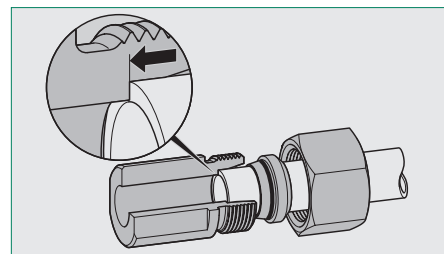

Carefully insert the tube end into the 24° taper of the pre-assembly stud and push it firmly against the inner stop.

The tube must be held in this position during the entire assembly process in order to avoid faulty assembly.

Q



Assembly Instructions for STAUFF Connect 24° Tube Fittings with Soft-Sealing Cutting Ring (Type FI-WDDS) 50% Assembly with the Manual Pre-Assembly Stud (Type FI-VK) and Assembly with the Fitting Body

3. Assembly in the Assembly Stud

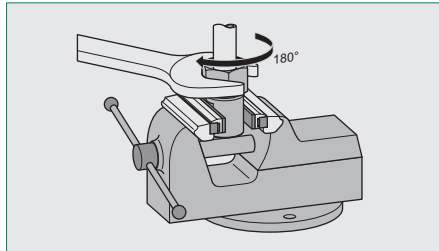
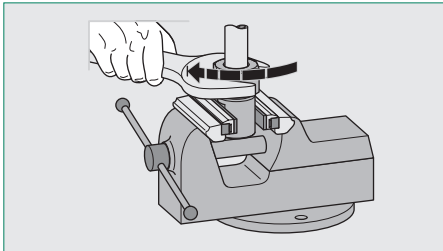

Tighten the union nut until the noticeable increase in force (pressure point). The cutting ring now grips the tube, which can no longer be rotated.

Use a suitable spanner to tighten the union nut another 1/2 a turn (180°) beyond the pressure point. In doing so, the cutting ring will uniformly cut into the tube.

4. Assembly with the Fitting Body

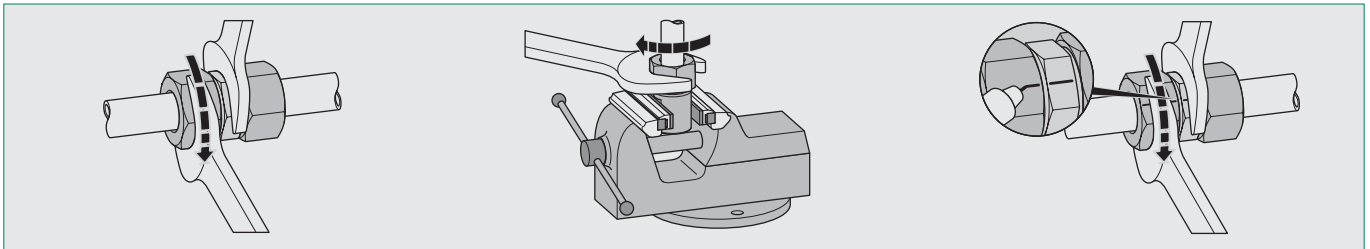

Lightly lubricate the soft-sealing element located on the 24° taper of the cutting ring (e.g. using mineral-oil based hydraulic fluid HLP32). Do not use lubricating grease!

Immediately proceed with the assembly in order to avoid exposure to contamination.

Carefully insert the assembled tube end into the 24° taper of the fitting body.

Use a suitable spanner to tighten the union nut until the point where the cutting ring comes into contact and sits closely with the face side of the fitting body, and pretension it.

This point is characterised by a significant increase in force and typically situated 1/2 to 1 turns (180° to 360°) beyond the fixed point.

Always use a second spanner to hold the fitting body during the entire assembly procedure.

In case of unfavourable mounting conditions or larger tube dimensions, use a bench vice for the assembly.

A marking line applied on the union nut and the fitting body makes it easier to indicate the sufficient tightening angle.

5. Inspection

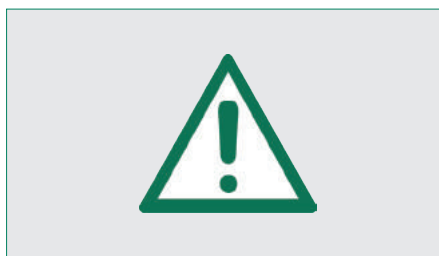
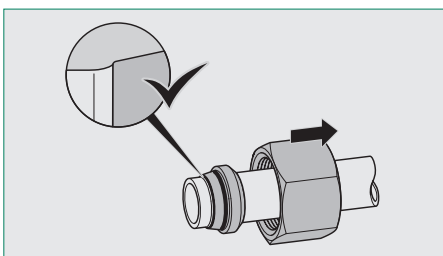

Fully untighten the union nut for a visual inspection after the assembly. A raise of tube material must be clearly visible in front of the cutting edge.

In this position, it is still permissible for the cutting ring to turn on the tube, but not to be displaced in axial direction of the tube.

Please note: If not enough tube material has been raised in front of the cutting edge or if the cutting ring is still capable of being displaced in axial direction, the assembly procedure must be repeated by using more force, and the result must be re-checked.

6. Repeated Assembly

Check the soft-sealing element located on the 24° taper of the cutting ring for possible damages.

Use a suitable spanner to tighten the union nut until the point where the cutting ring comes into contact and sits closely with the face side of the fitting body, and pretension it. This point is characterised by a significant increase in force.



Assembly Instructions for STAUFF Connect 24° Tube Fittings with Soft-Sealing Cutting Ring (Type FI-WDDS) Direct Assembly with the Fitting Body

1. Tube Preparation

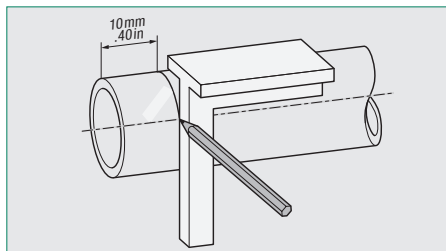

Saw off tube in right angle and at least 10 mm / .40 in from the cut made by the tube manufacturer / supplier in order to avoid failures caused during shipment.

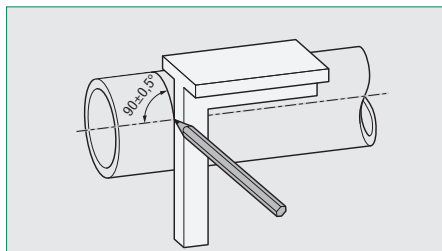

A maximum angular deviation / tolerance of $\pm 0,5^\circ$ relative to the tube axis is permissible.

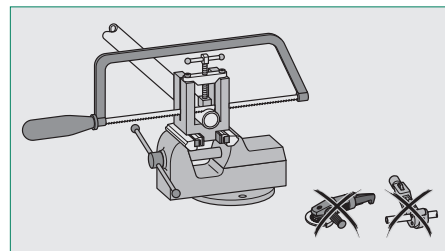

Only use proper tube sawing machinery or equipment. Do not use tube cutters or grinders as this may result in unwanted angled cuts and cause severe burring.

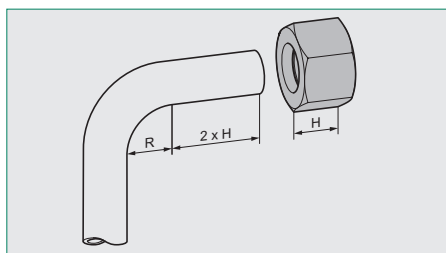

For tube bends, the length of the straight section of the tube end to the start of the bending radius has to be twice the height of the union nut.

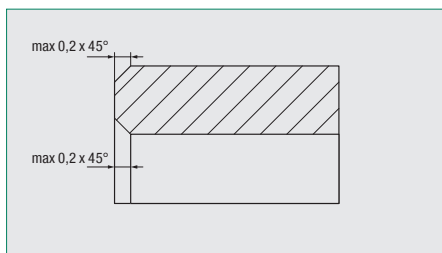

Slightly deburr inside and outside of the tube end (max 0,2 x 45°). The assembly area of the tube has to be free of contamination, chips and paint.

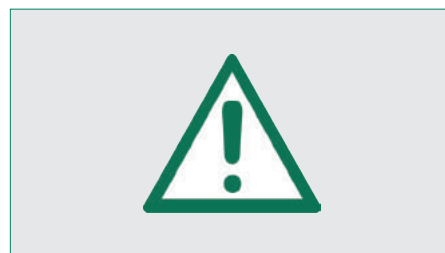

Please note: Improperly prepared and contaminated tubes will affect the service life of the connection and may result in leakage.

2. Assembly Preparation

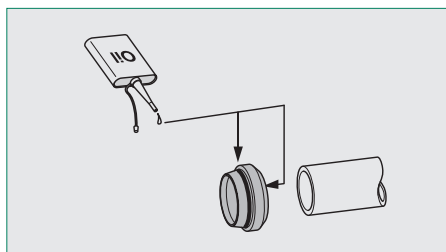

Lightly lubricate the two soft-sealing elements of the cutting ring (e.g. using mineral-oil based hydraulic fluid HLP32). Do not use lubricating grease!

Immediately proceed with the assembly in order to avoid exposure to contamination.

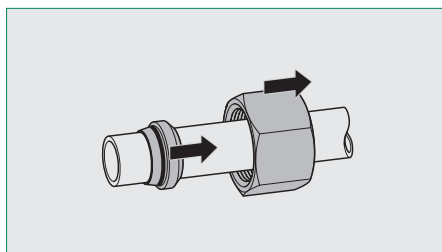

Consecutively put the union nut first and then the cutting ring onto the tube end.

Pay attention to the correct alignment of the cutting ring: The cutting edges have to face to the tube end.

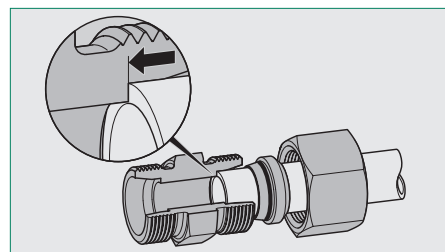

Carefully insert the tube end into the 24° taper of the fitting body and push it firmly against the inner stop.

The tube must be held in this position during the entire assembly process in order to avoid faulty assembly.



Assembly Instructions for STAUFF Connect 24° Tube Fittings with Soft-Sealing Cutting Ring (Type FI-WDDS) Direct Assembly with the Fitting Body

3. Assembly in the Fitting Body

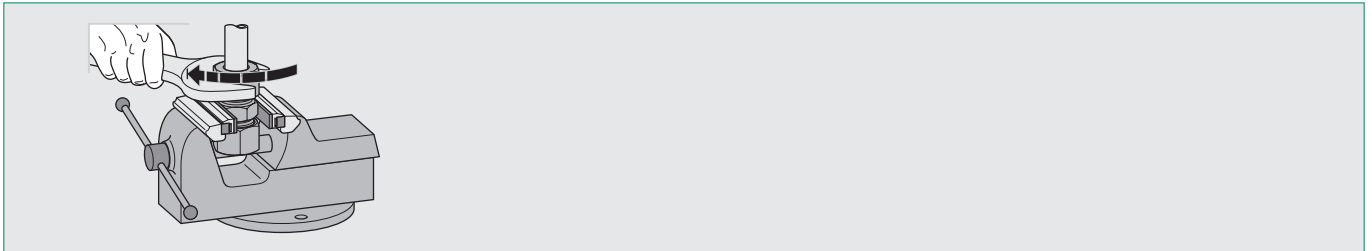

Use a suitable spanner to tighten the union nut until the point where the cutting ring comes into contact and sits closely with the face side of the fitting body, and pretension it.

This point is characterised by a significant increase in force and typically situated 1 to 1 1/2 turns (360° to 540°) beyond the pressure point.

At this point, the cutting ring starts gripping the tube, which can no longer be rotated.

4. Inspection

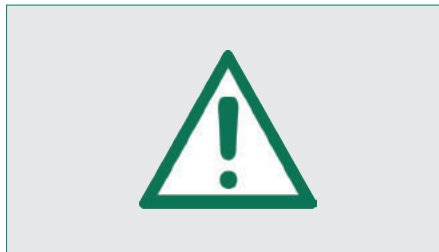
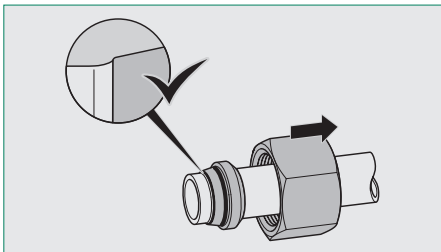

Fully untighten the union nut for a visual inspection after the assembly. A raise of tube material must be clearly visible in front of the cutting edge.

In this position, it is still permissible for the cutting ring to turn on the tube, but not to be displaced in axial direction of the tube.

Please note: If not enough tube material has been raised in front of the cutting edge or if the cutting ring is still capable of being displaced in axial direction, the assembly procedure must be repeated by using more force, and the result must be re-checked.

5. Repeated Assembly

Check the soft-sealing element located on the 24° taper of the cutting ring for possible damages.

Use a suitable spanner to tighten the union nut until the point where the cutting ring comes into contact and sits closely with the face side of the fitting body, and pretension it. This point is characterised by a significant increase in force.

Assembly Instructions for STAUFF Connect 24° Tube Fittings with Soft-Sealing Cutting Ring (Type FI-WDDS)

Machine-Assisted 100% Assembly with a STAUFF Press Assembly Machine and Assembly with the Fitting Body

1. Tube Preparation

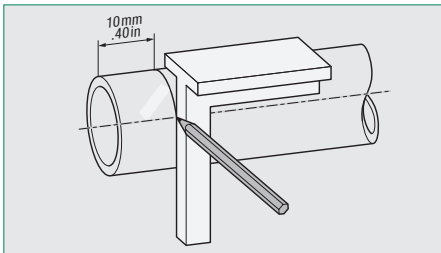

Saw off tube in right angle and at least 10 mm / .40 in from the cut made by the tube manufacturer / supplier in order to avoid failures caused during shipment.

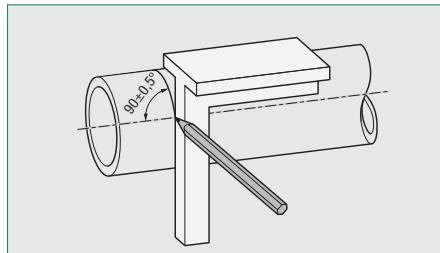

A maximum angular deviation / tolerance of $\pm 0,5^\circ$ relative to the tube axis is permissible.

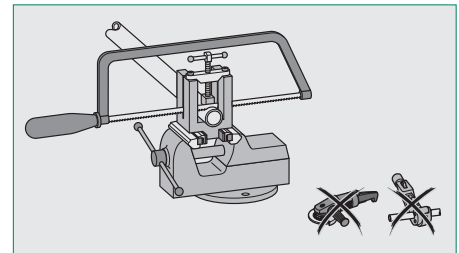

Only use proper tube sawing machinery or equipment. Do not use tube cutters or grinders as this may result in unwanted angled cuts and cause severe burring.

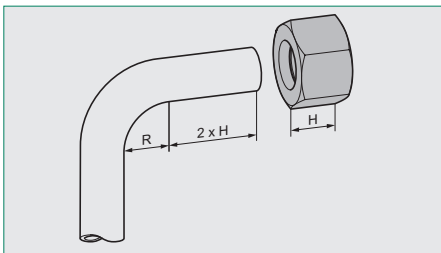

For tube bends, the length of the straight section of the tube end to the start of the bending radius has to be twice the height of the union nut.

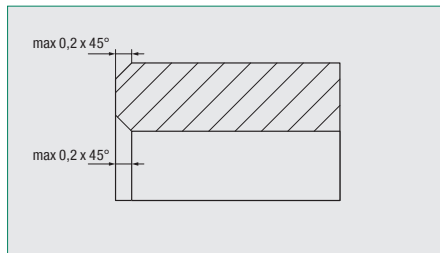

Slightly deburr inside and outside of the tube end (max 0,2 x 45°). The assembly area of the tube has to be free of contamination, chips and paint.

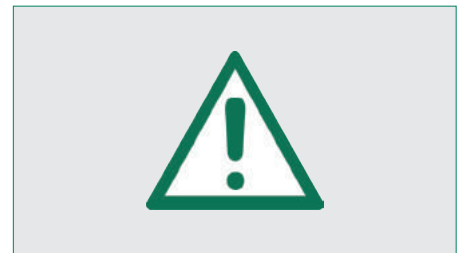

Please note: Improperly prepared and contaminated tubes will affect the service life of the connection and may result in leakage.

2. Assembly Preparation, Machine-Assisted Assembly and Inspection

With regards to assembly preparation, the actual assembly as well as the inspection of assembled tube ends, please follow the detailed instructions in the operating manual of the machine.



3. Assembly with the Fitting Body

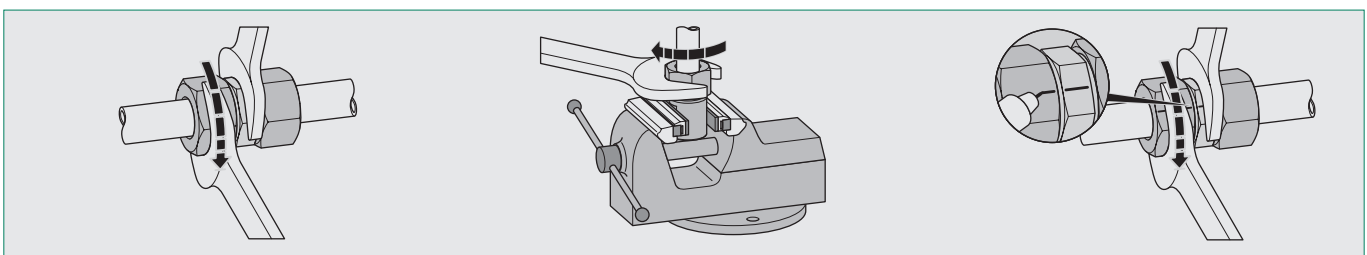

Lightly lubricate the soft-sealing element located on the 24° taper of the cutting ring (e.g. using mineral-oil based hydraulic fluid HLP32). Do not use lubricating grease!

Immediately proceed with the assembly in order to avoid exposure to contamination.

Carefully insert the assembled tube end into the 24° taper of the fitting body.

Use a suitable spanner to tighten the union nut until the point where the cutting ring comes into contact and sits closely with the face side of the fitting body, and pretension it. This point is characterised by a significant increase in force.

Always use a second spanner to hold the fitting body during the entire assembly procedure.

In case of unfavourable mounting conditions or larger tube dimensions, use a bench vice for the assembly.

A marking line applied on the union nut and the fitting body makes it easier to indicate the sufficient tightening angle.

4. Repeated Assembly

Check the soft-sealing element located on the 24° taper of the cutting ring for possible damages.

Use a suitable spanner to tighten the union nut until the point where the cutting ring comes into contact and sits closely with the face side of the fitting body, and pretension it. This point is characterised by a significant increase in force.

Q



Assembly Instructions for STAUFF Connect 24° Tube Fittings with Soft-Sealing Cutting Ring (Type FI-WDDS)

Machine-Assisted 50% Assembly with a STAUFF Press Assembly Machine and Assembly with the Fitting Body

1. Tube Preparation

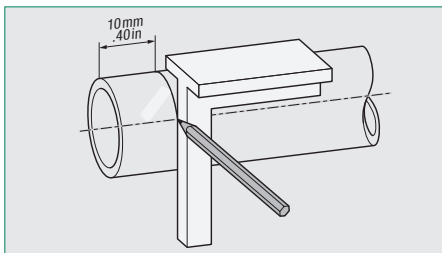

Saw off tube in right angle and at least 10 mm / .40 in from the cut made by the tube manufacturer / supplier in order to avoid failures caused during shipment.

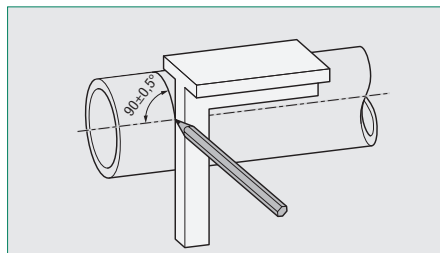

A maximum angular deviation / tolerance of $\pm 0,5^\circ$ relative to the tube axis is permissible.

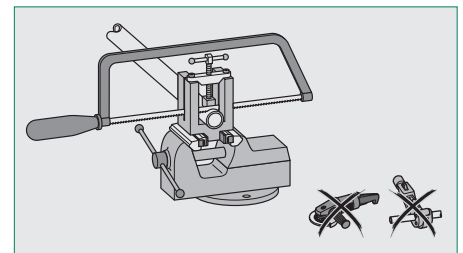

Only use proper tube sawing machinery or equipment. Do not use tube cutters or grinders as this may result in unwanted angled cuts and cause severe burring.

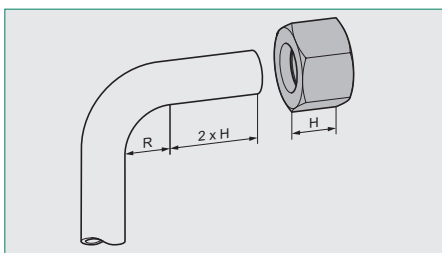

For tube bends, the length of the straight section of the tube end to the start of the bending radius has to be twice the height of the union nut.

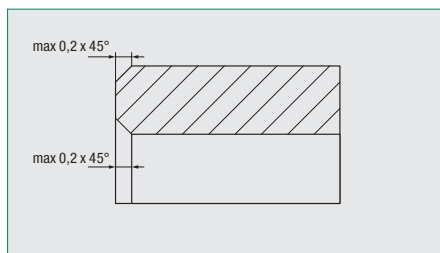

Slightly deburr inside and outside of the tube end (max 0,2 x 45°). The assembly area of the tube has to be free of contamination, chips and paint.

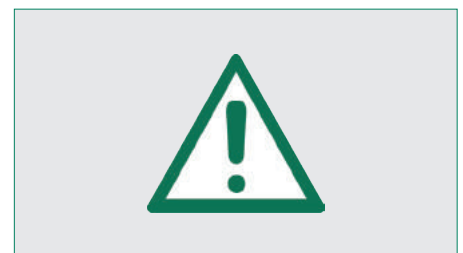

Please note: Improperly prepared and contaminated tubes will affect the service life of the connection and may result in leakage.

2. Assembly Preparation, Machine-Assisted Assembly and Inspection

With regards to assembly preparation, the actual assembly as well as the inspection of assembled tube ends, please follow the detailed instructions in the operating manual of the machine.



3. Assembly with the Fitting Body

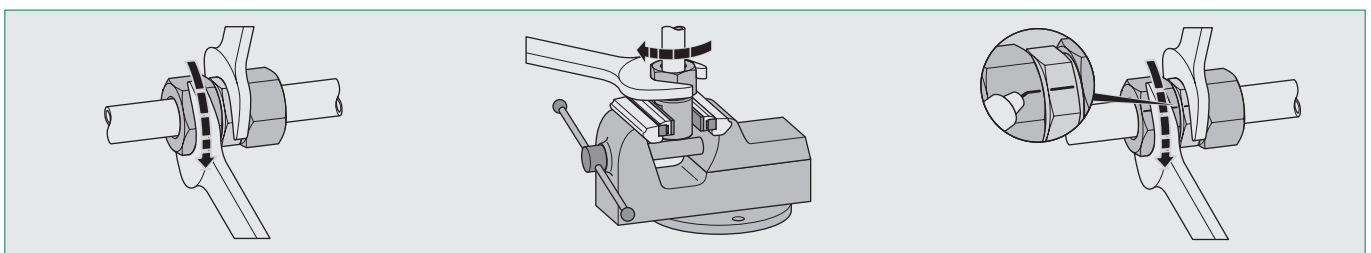

Lightly lubricate the soft-sealing element located on the 24° taper of the cutting ring (e.g. using mineral-oil based hydraulic fluid HLP32). Do not use lubricating grease!

Immediately proceed with the assembly in order to avoid exposure to contamination.

Carefully insert the assembled tube end into the 24° taper of the fitting body.

Use a suitable spanner to tighten the union nut until the point where the cutting ring comes into contact and sits closely with the face side of the fitting body, and pretension it.

This point is characterised by a significant increase in force and typically situated 1/2 to 1 turns (180° to 360°) beyond the fixed point.

Always use a second spanner to hold the fitting body during the entire assembly procedure.

In case of unfavourable mounting conditions or larger tube dimensions, use a bench vice for the assembly.

A marking line applied on the union nut and the fitting body makes it easier to indicate the sufficient tightening angle.

4. Repeated Assembly

Check the soft-sealing element located on the 24° taper of the cutting ring for possible damages.

Use a suitable spanner to tighten the union nut until the point where the cutting ring comes into contact and sits closely with the face side of the fitting body, and pretension it. This point is characterised by a significant increase in force.



Assembly Instructions for Support Sleeves (Type FI-VH)

Selection Chart for Tubes made of Steel / Stainless Steel

Series	Tube OD		Tube Wall Thickness										
	(mm)	(in)	(mm)	0,5	0,75	1,0	1,5	2,0	2,5	3,0	3,5	4,0	
LL	4	.16											
	6	.24	●										
	8	.31	●										
L	6	.24	●	●									
	8	.31	●	●									
	10	.39	●	●									
	12	.47	●	●	○								
	15	.59	●	●	●								
	18	.71	●	●	●	○							
	22	.87	●	●	●	○	○						
	28	1.10	●	●	●	○	○						
	35	1.38	●	●	●	●	○	○					
	42	1.65	●	●	●	●	○	○					
S	6	.24	●	●									
	8	.31	●	●									
	10	.39	●	●									
	12	.47	●	●	○								
	14	.55	●	●	●								
	16	.63	●	●	●	○							
	20	.79	●	●	●	●	○						
	25	.98	●	●	●	●	○						
	30	1.18	●	●	●	●	●	○					
	38	1.50	●	●	●	●	●	●	○	○			

Selection Chart for Tubes made of Non-Ferrous Metals

Series	Tube OD		Tube Wall Thickness										
	(mm)	(in)	(mm)	0,5	0,75	1,0	1,5	2,0	2,5	3,0	3,5	4,0	
LL	4	.16											
	6	.24	●	●									
	8	.31	●	●									
L	6	.24	●	●	●								
	8	.31	●	●	●								
	10	.39	●	●	●	○							
	12	.47	●	●	●	●							
	15	.59	●	●	●	●							
	18	.71	●	●	●	●	●						
	22	.87	●	●	●	●	●	●					
	28	1.10	●	●	●	●	●	●	●				
	35	1.38	●	●	●	●	●	●	●	●			
	42	1.65	●	●	●	●	●	●	●	●	●		
S	6	.24	●	●	●								
	8	.31	●	●	●								
	10	.39	●	●	●								
	12	.47	●	●	●								
	14	.55	●	●	●	●							
	16	.63	●	●	●	●	●						
	20	.79	●	●	●	●	●	●					
	25	.98	●	●	●	●	●	●	●				
	30	1.18	●	●	●	●	●	●	●	●			
	38	1.50	●	●	●	●	●	●	●	●	●	●	

● Generally required ○ Highly recommended, especially for adverse operating conditions (vibrations, risks of self-loosening of fittings etc.)

Support sleeves are generally required for use with tubes made of plastics.

Assembly

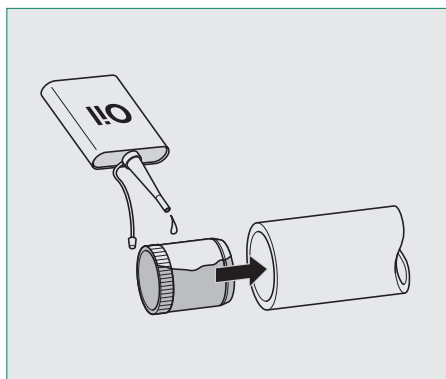

Lubricate the outside of the support sleeve (e.g. using mineral-oil based hydraulic fluid HLP32) and insert it into the tube end up to the knurled section.

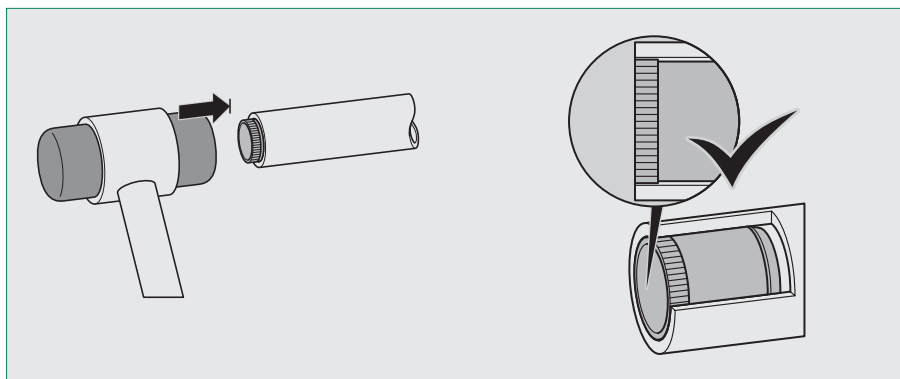

Use a hammer (plastic or rubber) to fully drive the support sleeve into the tube end, so that the knurled section is pressed against the inner wall of the tube and the sleeve is firmly flush with the tube end.

In doing so, the support sleeve is prevented from subsequent turning, sliding and falling out.



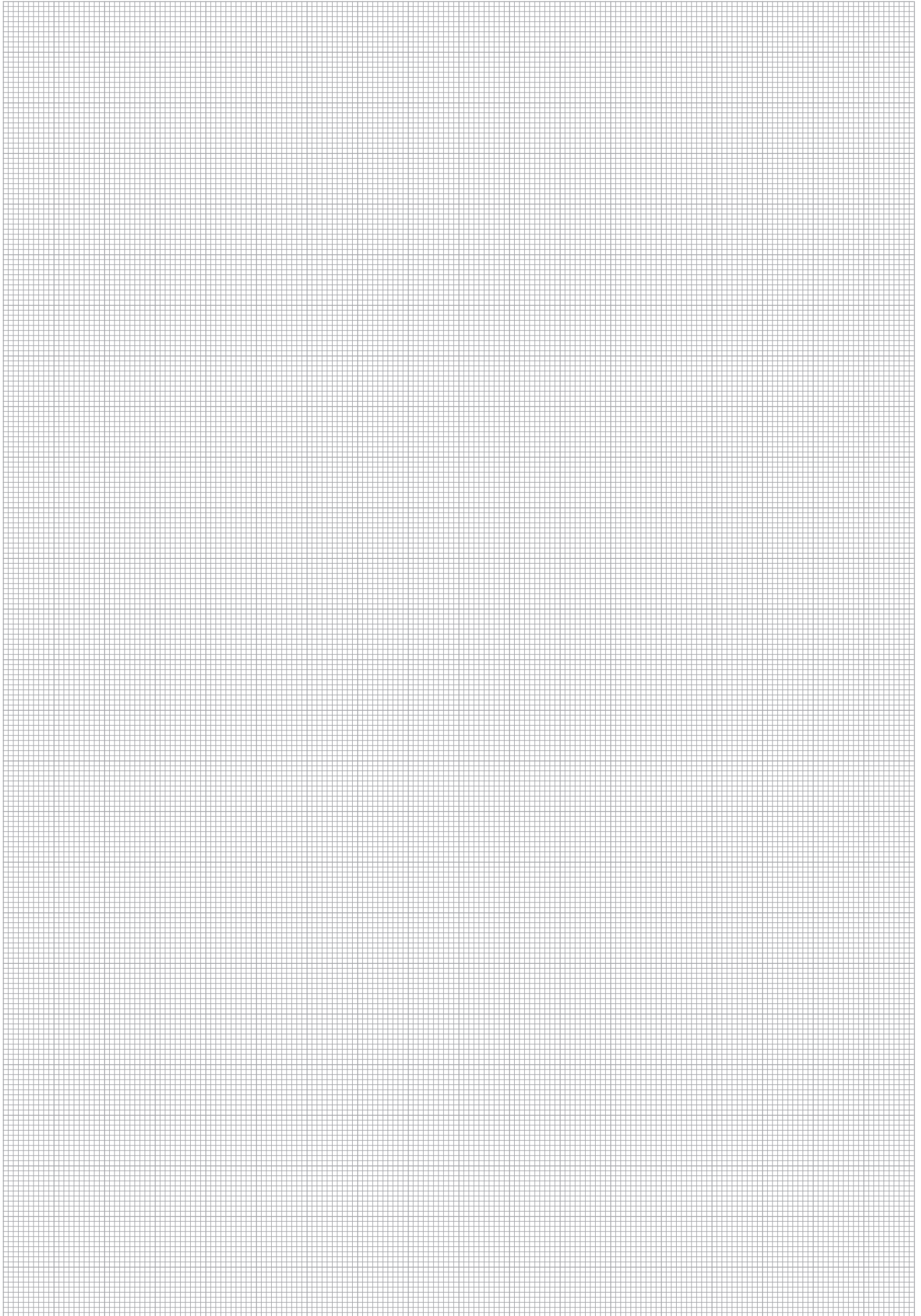

Q



Assembly Instructions for STAUFF Form Tube Fittings

Tube End Forming with a STAUFF Form Machine and Assembly with the Fitting Body

1. Tube Preparation

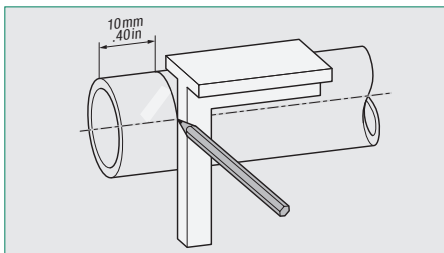

Saw off tube in right angle and at least 10 mm / .40 in from the cut made by the tube manufacturer / supplier in order to avoid failures caused during shipment.

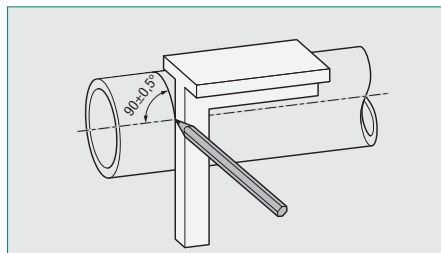

A maximum angular deviation / tolerance of $\pm 0,5^\circ$ relative to the tube axis is permissible.

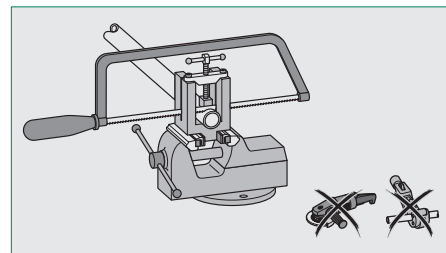

Only use proper tube sawing machinery or equipment. Do not use tube cutters or grinders as this may result in unwanted angled cuts and cause severe burring.

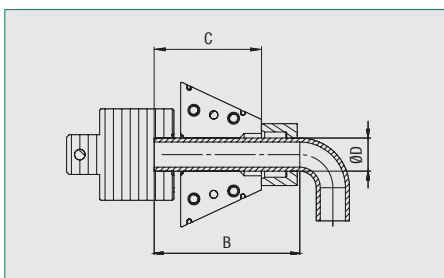
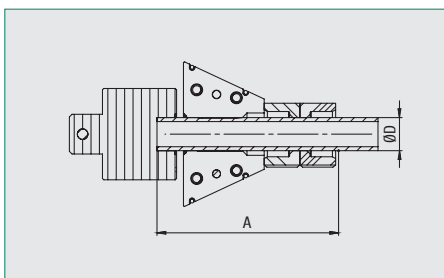

Series	Tube OD		Minimum Length A		Minimum Length B		Insertion Depth C	
	(mm)	(in)	Straight Tube Ends		Straight Sections next to Tube Bends		(mm)	(in)
L	6	.24	109	4.29	94	3.70	79,5	3.13
	8	.31	107	4.21	92	3.62	77,5	3.05
	10	.39	111	4.37	95	3.74	79,5	3.13
	12	.47	110	4.33	94	3.70	78,5	3.09
	15	.59	113	4.45	96	3.78	79	3.11
	18	.71	114	4.48	96	3.78	78	3.07
	22	.87	120	4.72	100	3.94	80	3.15
	28	1.10	123	4.84	101	3.98	79	3.11
S	35	1.38	143	5.63	118	4.65	93	3.66
	42	1.65	144	5.67	119	4.69	94	3.70
	6	.24	113	4.45	96	3.78	79,5	3.13
	8	.31	111	4.37	94	3.70	77,5	3.05
	10	.39	115	4.53	97	3.82	79,5	3.13
	12	.47	114	4.49	96	3.78	78,5	3.09
	16	.63	120	4.72	99	3.90	78,5	3.09
	20	.79	130	5.12	106	4.17	82	3.23
	25	.98	147	5.79	120	4.72	93	3.66
	30	1.18	155	6.10	126	4.96	97	3.82
38	1.50	168	6.61	135	5.31	102,5	4.04	

Please note the minimum lengths for straight tube ends (dimension A) as well as for straight tube sections next to tube bends (dimension B) that are listed in the table.

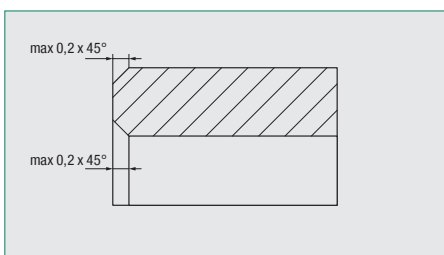

Slightly deburr inside and outside of the tube end (max 0,2 x 45°). The assembly area of the tube has to be free of contamination, chips and paint.

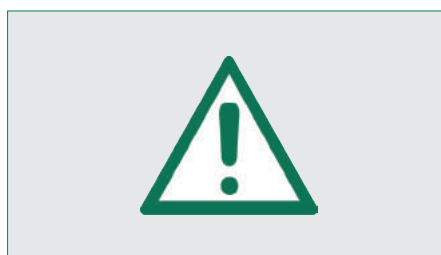

Please note: Improperly prepared and contaminated tubes will affect the service life of the connection and may result in leakage.



2. Preparation and Machine-Assisted Tube Forming

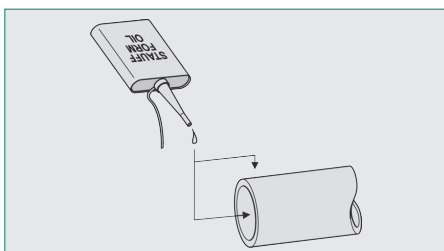

Lightly lubricate the inside and outside of the tube end (e.g. with a thin film of mineral-oil based hydraulic fluid HLP32) before starting the machine-assisted tube forming process. Do not use lubricating grease!

If the lubricant film on the outside of the tube end is too thick, fluid will be trapped between the forming tool and the tube end, thus resulting in inaccurate contours.

Immediately proceed with the assembly in order to avoid exposure to contamination.

With regards to the actual tube forming process, please follow the detailed instructions in the operating manual of the machine.

Important: For tube ends made of stainless steel, always and only use original STAUFF Form Oil (type SFO-FO-1L). The use of any other fluid is not allowed and may result in damage of the assembly tools.

Q



Assembly Instructions for STAUFF Form Tube Fittings

Tube End Forming with a STAUFF Form Machine and Assembly with the Fitting Body

3. Inspection

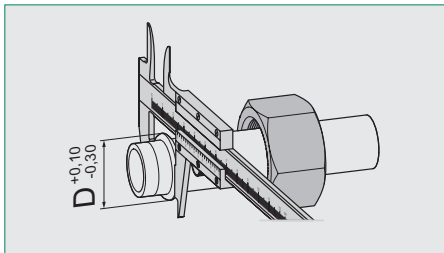

Use a suitable measuring device (caliper gauge) to check control diameter D of the formed tube end based on the dimension table on the right.

Series	Tube OD		Dimensions D		
	(mm)	(in)	(mm)	(in)	
L	6	.24	10,1	.40	
	8	.31	12,1	.48	
	10	.39	14,0	.55	
	12	.47	16,1	.63	
	15	.59	20,1	.79	
	18	.71	23,7	.93	
	22	.87	27,1	1.07	
	28	1.10	33,1	1.30	
	35	1.38	42,1	1.66	
	42	1.65	49,4	1.94	
	S	6	.24	10,1	.40
		8	.31	12,1	.48
10		.39	14,0	.55	
12		.47	16,1	.63	
16		.63	21,7	.85	
20		.79	26,1	1.03	
25		.98	31,1	1.22	
30		1.18	37,1	1.46	
38		1.50	46,9	1.85	

4. Assembly with the Fitting Body

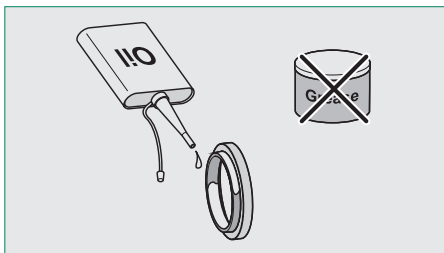

Lightly lubricate the inside and outside of the sealing element of the form ring (e.g. using mineral-oil based hydraulic fluid HLP32). Do not use lubricating grease!

Immediately proceed with the assembly in order to avoid exposure to contamination.

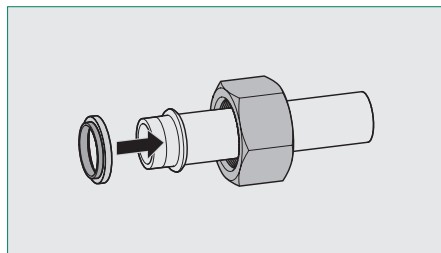

Slide the form ring onto the formed tube end (with the sealing element of the form ring facing to the tube end).

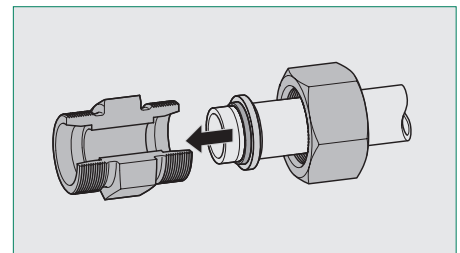

Carefully insert the formed tube end with the assembled form ring into the 24° taper of the fitting body.

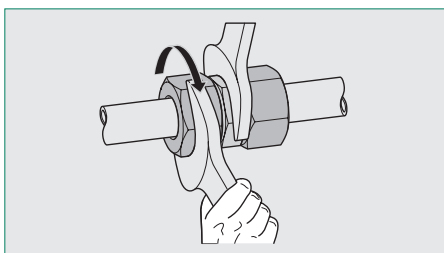

Use a suitable spanner to tighten the nut until there is a noticeable increase in force required (fixed point).

Avoid over-tightening by gripping the spanner close to the union nut.

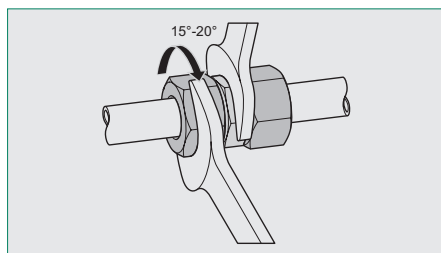

Finish the assembly by using a suitable spanner to tighten the union nut approximately 15-20° beyond the fixed point.

Always use a second spanner to hold the fitting body during the entire assembly procedure.

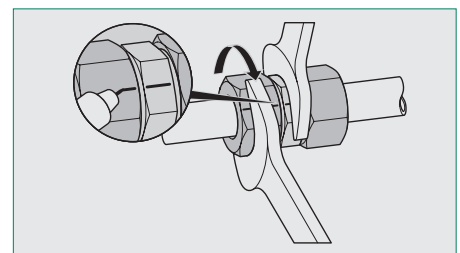

A marking line applied on the union nut and the fitting body makes it easier to indicate the sufficient tightening angle.

5. Repeated Assembly

For repeated assemblies, please follow the instructions from point 4 on.



Assembly Instructions for STAUFF Form Tube Fittings

Tube End Forming with a STAUFF Form Machine and Assembly with the Fitting Body

Calculation Dimensions

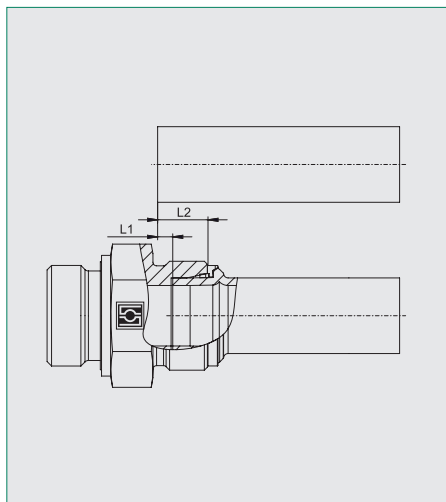
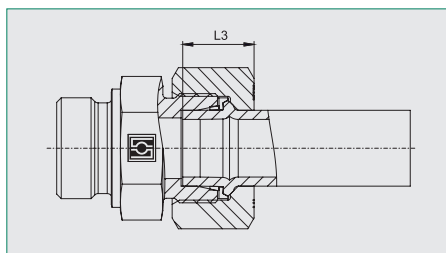

Tube OD		Tube Wall Thickness		L1		L2		L3	
(mm)	(in)	(mm)	(in)	(mm)	(in)	(mm)	(in)	(mm)	(in)
6	.24	1,5	.06	6,9	.27	13,5	.53	14,6 (L+S)	.57 (L+S)
		1,5	.06	6,0	.24	12,6	.50		
8	.31	2,0	.08	5,2	.20	11,8	.46	14,6 (L+S)	.57 (L+S)
		1,5	.06	5,5	.22	12,1	.48		
10	.39	2,0	.08	4,1	.16	10,7	.42	15,1 (L)	.59 (L)
		2,5	.10	4,8	.19	11,4	.45	16,1 (S)	.63 (S)
		3,0	.12	4,2	.17	10,8	.43		
		1,5	.06	4,9	.19	11,5	.45		
12	.47	2,0	.08	4,6	.18	11,2	.44	15,3 (L)	.60 (L)
		2,5	.10	4,4	.17	11,0	.43	16,3 (S)	.64 (S)
		3,0	.12	4,3	.17	10,9	.43		
		1,5	.06	6,3	.25	12,9	.51		
15	.59	2,0	.08	5,8	.23	12,4	.49	15,6	.61
		2,5	.10	5,4	.21	12,0	.47		
		2,0	.08	6,6	.26	14,6	.57		
16	.63	2,5	.10	6,0	.24	14,0	.55	18,4	.72
		3,0	.12	6,0	.24	14,0	.55		
		4,0	.16	6,0	.24	14,0	.55		
		2,0	.08	6,1	.24	13,0	.51		
18	.71	2,5	.10	6,2	.24	13,1	.52	16,3	.64
		3,0	.12	6,2	.24	13,1	.52		
		2,0	.08	4,5	.18	14,5	.57		
20	.79	2,5	.10	7,2	.28	17,2	.68	21,1	.83
		3,0	.12	6,8	.27	16,8	.66		
		4,0	.16	7,0	.28	17,0	.67		
		2,0	.08	6,4	.25	13,4	.53		
22	.87	2,5	.10	6,0	.24	13,0	.51	17,5	.69
		3,0	.12	5,5	.22	12,5	.49		
		3,5	.14	6,1	.24	13,1	.52		
		2,0	.08	6,1	.24	17,6	.69		
25	.98	2,5	.10	7,0	.28	18,5	.73	23,5	.93
		3,0	.12	7,1	.28	18,6	.73		
		3,5	.14	6,3	.25	17,8	.70		
		4,0	.16	7,5	.30	19,0	.75		
		5,0	.20	7,1	.28	18,6	.73		
28	1.10	2,0	.08	5,0	.20	12,0	.47		
		2,5	.10	5,6	.22	12,6	.50	17,9	.70
		3,0	.12	6,0	.24	13,0	.51		
		3,5	.14	5,0	.20	12,0	.47		
		4,0	.16	5,0	.20	12,0	.47		
30	1.18	2,5	.10	7,5	.30	20,5	.81		
		3,0	.12	8,5	.33	21,5	.85	27,8	1.09
		4,0	.16	8,6	.34	21,6	.85		
		5,0	.20	8,5	.33	21,5	.85		
		6,0	.24	8,8	.35	21,8	.86		
35	1.38	2,5	.10	8,0	.31	20,8	.82		
		3,0	.12	8,0	.31	20,8	.82	22,6	.89
		4,0	.16	9,0	.35	21,8	.86		
		5,0	.20	9,5	.37	22,3	.88		
38	1.50	3,0	.12	10,0	.39	25,5	1.00		
		4,0	.16	10,5	.41	26,0	1.02	31,6	1.24
		5,0	.20	11,5	.45	27,0	1.06		
		6,0	.24	11	.43	26,5	1.04		
42	1.65	3,0	.12	8,4	.33	18,9	.74		
		3,5	.14	8,8	.35	19,3	.76	23,2	.91
		4,0	.16	7,0	.28	17,5	.69		



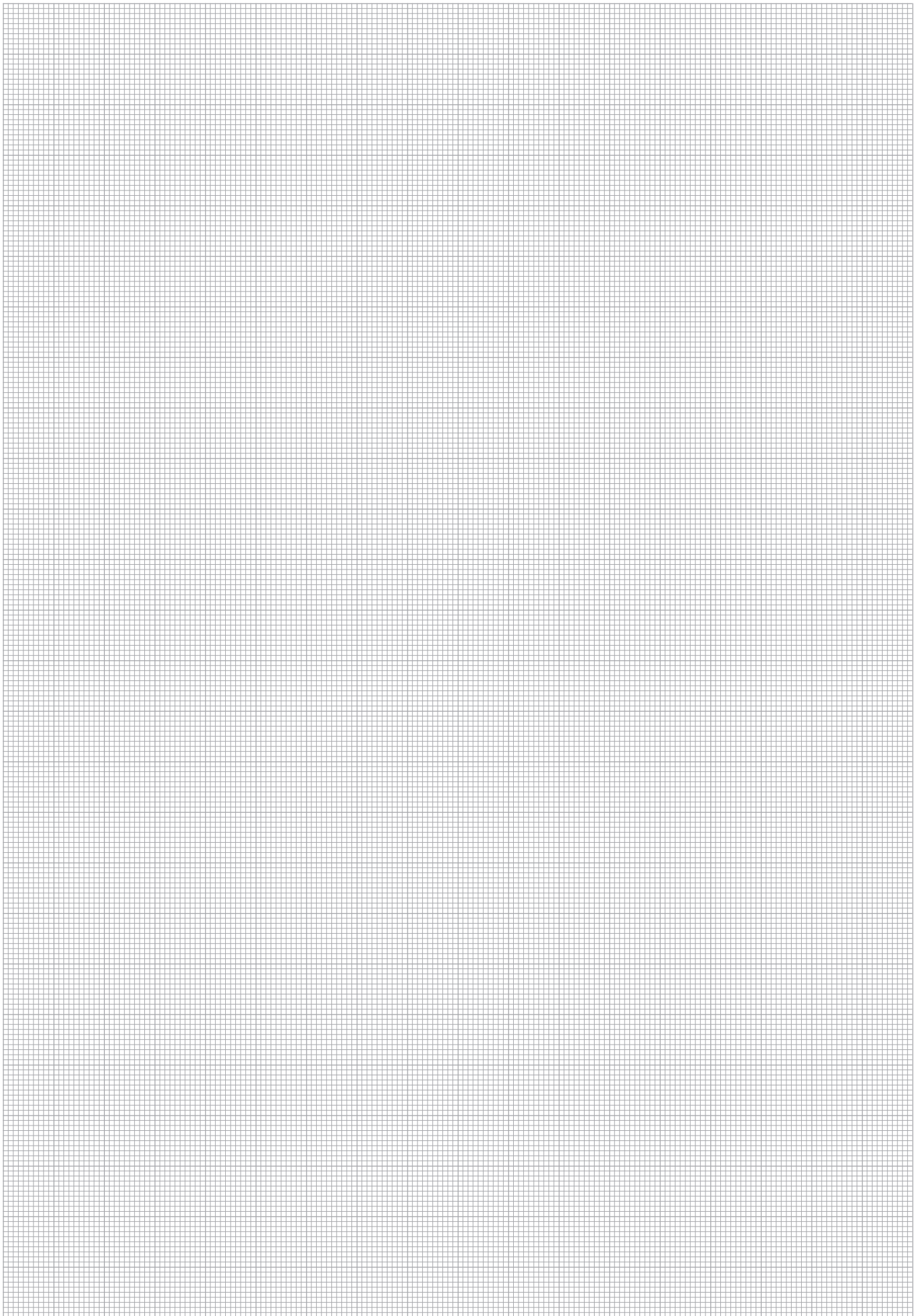

Q



Assembly Instructions for STAUFF Connect 37° Flared Tube Fittings

Tube Flaring with a STAUFF Press Machine and Assembly with the Fitting Body

1. Tube Preparation

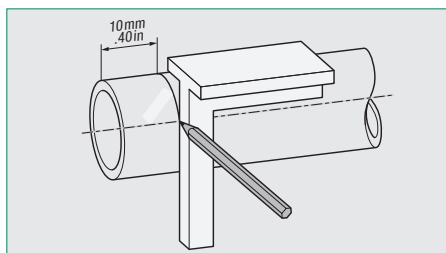

Saw off tube in right angle and at least 10 mm / .40 in from the cut made by the tube manufacturer / supplier in order to avoid failures caused during shipment.

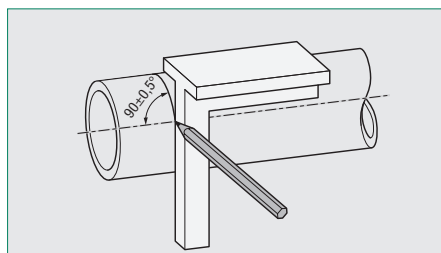

A maximum angular deviation / tolerance of $\pm 0,5^\circ$ relative to the tube axis is permissible.

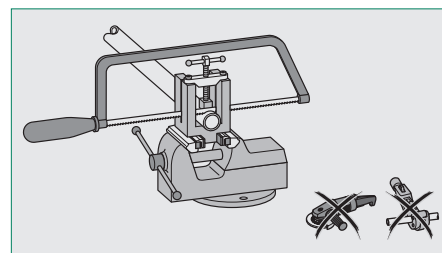

Only use proper tube sawing machinery or equipment. Do not use tube cutters or grinders as this may result in unwanted angled cuts and cause severe burring.

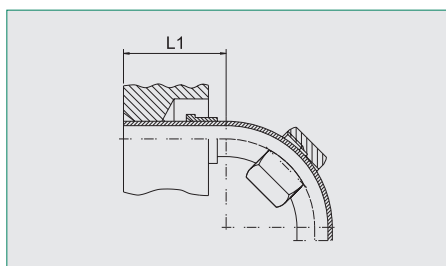
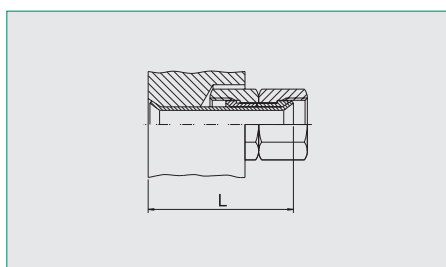

Series	Tube OD		Minimum Length L Straight Tube Sections		Minimum Length L1 Straight Tube Sections next to Tube Bends	
	(mm)	(in)	(mm)	(in)	(mm)	(in)
L	6	.24	59	2.32	43	1.69
	8	.31	62	2.44	44	1.73
	10	.39	64	2.52	46	1.81
	12	.47	67	2.64	47	1.85
	15	.59	75	2.95	50	1.97
	18	.71	76	2.99	58	2.28
	22	.87	81	3.19	60	2.36
	28	1.10	88	3.46	60	2.36
	35	1.38	92	3.62	62	2.44
	42	1.65	130	5.12	70	2.76
S	6	.24	61	2.40	43	1.69
	8	.31	64	2.52	44	1.73
	10	.39	66	2.60	46	1.81
	12	.47	68	2.68	47	1.85
	16	.63	79	3.11	52	2.05
	20	.79	82	3.23	58	2.28
	25	.98	94	3.70	60	2.36
	30	1.18	96	3.78	62	2.44
38	1.50	136	5.35	70	2.76	

Please note the minimum lengths for straight tube ends (dimension L) as well as for straight tube sections next to tube bends (dimension L1) that are listed in the table. If installation situations demand that the length of straight tube sections next to tube bends (dimension L1) has to be shorter than indicated in the table, tube bending has to be carried out after flaring.

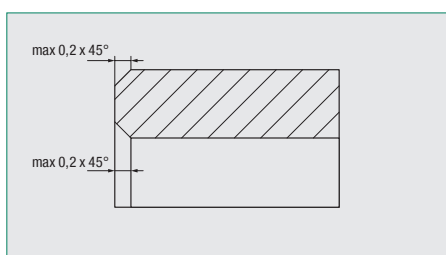

Slightly deburr inside and outside of the tube end (max 0,2 x 45°). The assembly area of the tube has to be free of contamination, chips and paint.

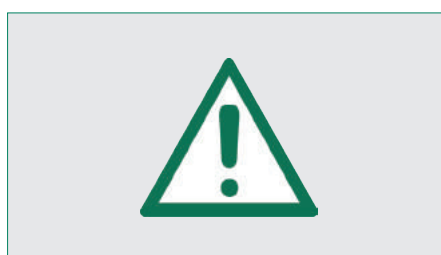

Please note: Improperly prepared and contaminated tubes will affect the service life of the connection and may result in leakage.

2. Preparation and Machine-Assisted Tube Flaring

With regards to assembly preparation as well as the actual tube flaring process, please follow the detailed instructions in the operating manual of the machine.

Q



Assembly Instructions for STAUFF Connect 37° Flared Tube Fittings

Tube Flaring with a STAUFF Press Machine and Assembly with the Fitting Body

3. Inspection

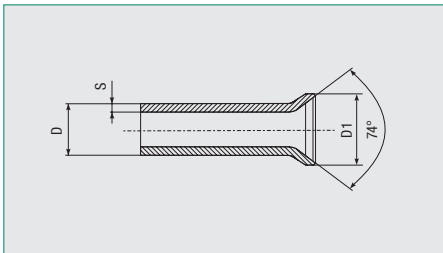

Check the flared tube end for cracking and impurities after flaring.

Always verify the dimensional accuracy of the flare.

The checking diameter corresponds to the outside diameter D1 of the flared tube end (according to dimension table on the right). The flare must be at right angle to the tube axis and concentric with the tube.

Please note: If the flare is eccentric, too short or not wide enough, perfect function of the tube fitting cannot be guaranteed!

4. Assembly with the Fitting Body

Lubricate the o-rings of the 24°/37° flared tube adaptor (e.g. using mineral-oil based hydraulic fluid HLP32) and carefully insert it into the 24° taper of the fitting body.

It is recommended to use a bench vice to press and permanently capture the 24°/37° flared tube adaptor into the 24° taper of the tube fitting – a great help to the tube fitter during re-assembly. In this case, please make sure that all components are suitably protected against damage.

Apply the flared tube end to the 24°/37° flared tube adaptor, which is attached to the fitting body, tighten the union nut until the noticeable increase in force, and then finish the assembly with another approximately 1/2 a turn (180°) beyond this point.

Important: Always use a spanner to hold the fitting body during the assembly procedure.

Tube OD		Dimensions		D1 _{min}		D1 _{max}	
D (mm)	(in)	S (mm)	(in)	(mm)	(in)	(mm)	(in)
6	.24	1	.04	9,1	.36	10	.39
		1,5	.06				
8	.31	1	.04	11,3	.44	12	.47
		1,5	.06				
		2	.08				
10	.39	1	.04	13,1	.52	14	.55
		1,5	.06				
		2	.08				
12	.47	1	.04	15,3	.60	16	.63
		1,5	.06				
		2	.08				
14	.55	1,5	.06	18,6	.73	19,6	.77
		2	.08				
		2,5	.10				
		3	.12				
15	.59	1,5	.06	19,1	.75	20	.79
		2	.08				
		2,5	.10				
16	.63	1,5	.06	20,6	.81	22	.87
		2	.08				
		2,5	.10				
		3	.12				
18	.71	1,5	.06	23,2	.91	24	.94
		2	.08				
		2,5	.10				
20	.79	2	.08	25,6	1.01	26,8	1.06
		2,5	.10				
		3	.12				
		3,5	.14				
22	.87	1,5	.06	26,5	1.04	27,5	1.08
		2	.08				
		2,5	.10				
		3	.12				
25	.98	2	.08	31,1	1.22	33	1.30
		2,5	.10				
		3	.12				
		4	.16				
28	1.10	2	.08	32,7	1.29	33,3	1.31
		2,5	.10				
		3	.12				
30	1.18	2	.08	37	1.46	38,7	1.52
		2,5	.10				
		3	.12				
		4	.16				
		5	.20				
35	1.38	2	.08	41,8	1.65	42,7	1.68
		2,5	.10				
		3	.12				
		4	.16				
38	1.50	2,5	.10	46	1.81	47,2	1.86
		3	.12				
		4	.16				
		5	.20				
		2	.08				
42	1.65	2	.08	48,8	1.92	49,8	1.96
		3	.12				
		4	.16				

5. Repeated Assembly

For repeated assembly, the union nut has to be tightened using exactly the same force as for the original assembly.



Assembly Instructions for STAUFF Connect 37° Flared Tube Fittings

Tube Flaring with a STAUFF Press Machine and Assembly with the Fitting Body

Calculation Dimensions

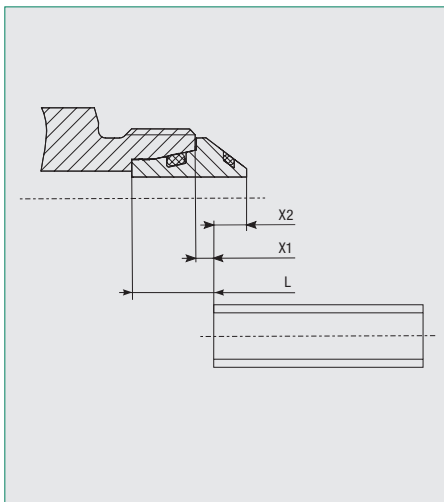

The correct tube length can be determined by measuring the distance between the 24°/37° flared tube adaptors pressed into the fitting bodies. Dimension X2 has then to be added for each of the connections.

The correct tube length can also be determined by measuring the distance between the fitting bodies. Dimension X1 has then to be subtracted for each of the connections.

Dimension L corresponds to the difference in tube length compared to cutting ring fittings. When changing over from cutting ring fittings to flared tube fittings, the tube has to be shortened by dimension L.

Tube OD		Dimensions					
D (mm)	(in)	X1		X2		L	
		(mm)	(in)	(mm)	(in)	(mm)	(in)
6	.24	1	.04	3,5	.14	8	.31
		2	.08	2,5	.10	9	.35
8	.31	1	.04	4	.16	8	.31
		2	.08	3	.12	9	.35
		2,5	.10	2,5	.10	9,5	.37
10	.39	1	.04	4,5	.18	8	.31
		2	.08	3,5	.14	9	.35
		3	.12	2,5	.10	10	.39
12	.47	1	.04	4,5	.18	8	.31
		2	.08	3,5	.14	9	.35
		3	.12	2,5	.10	10	.39
14	.55	0,5	.02	5,5	.22	8,5	.33
		1	.04	5	.20	9	.35
		2	.08	4	.16	10	.39
		3	.12	3	.12	11	.43
15	.59	1	.04	4,5	.18	8	.31
		2	.08	3,5	.14	9	.35
		3	.12	2,5	.10	10	.39
16	.63	0	.00	6,5	.26	8,5	.33
		1	.04	5,5	.22	9,5	.37
		1,5	.06	5	.20	10	.39
		2,5	.10	4	.16	11	.43
18	.71	0	.00	5,5	.22	7,5	.30
		1	.04	4,5	.18	8,5	.33
		1,5	.06	4	.16	9	.35
20	.79	1	.04	7	.28	11,5	.45
		2	.08	6	.24	12,5	.49
		3	.12	5	.20	13,5	.53
		4	.16	4	.16	14,5	.57
22	.87	1	.04	5,7	.22	8,5	.33
		2	.08	4,7	.19	9,5	.37
		3	.12	3,7	.15	10,5	.41
		3,5	.14	3,2	.13	11	.43
25	.98	1	.04	7	.28	13	.51
		1,5	.06	6,5	.26	13,5	.53
		2,5	.10	5,5	.22	14,5	.57
		4	.16	4	.16	16	.63
28	1.10	1,5	.06	5,7	.22	9	.35
		2,5	.10	4,7	.19	10	.39
		3	.12	4,2	.17	10,5	.41
30	1.18	-0,5	-.02	9	.35	13	.51
		0,5	.02	8	.31	14	.55
		1	.04	7,5	.30	14,5	.57
		3	.12	5,5	.22	16,5	.65
		4,5	.18	4	.16	18	.71
35	1.38	1,5	.06	6,5	.26	12	.47
		2	.08	6	.24	12,5	.49
		3	.12	5	.20	13,5	.53
		4,5	.18	3,5	.14	15	.59
38	1.50	0	.00	10	.39	16	.63
		0,5	.02	9,5	.37	16,5	.65
		2	.08	8	.31	18	.71
		4	.16	6	.24	20	.79
42	1.65	1,5	.06	7	.28	12,5	.49
		3	.12	6,5	.26	14	.55
		4,5	.18	5	.20	15,5	.61



Assembly Instructions for STAUFF Connect 37° Flared Tube Fittings

Tube Flaring with a STAUFF Press Machine and Assembly with the Fitting Body

Calculation Dimensions

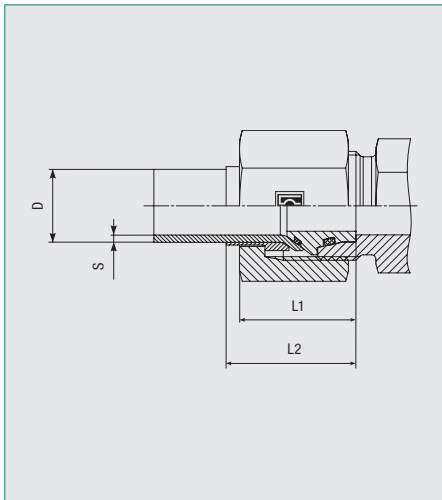

Series	Tube OD x Wall Thickness (mm/in) D x S	Dimensions (mm/in)		Corrected Tube Lengths for Different Wall Thicknesses (mm/in)										
		L1	L2	1	1,5	2	2,5	3	3,5	4	5			
L	6 x 1	17,5	20,5	•	1	1								
	.24 x .04	.69	.81		.04	.04								
	8 x 1	18,5	21,5	•	1	1,5								
	.31 x .04	.73	.85		.04	.06								
	10 x 1,5	19,5	24	-1	•	1								
	.39 x .06	.77	.94	-.04		.04								
	12 x 1,5	20	24,5	-1	•	1								
	.47 x .06	.79	.96	-.04		.04								
	15 x 1,5	21,5	25,5		•	1	2							
	.59 x .06	.85	1.00			.04	.08							
	18 x 2	23	27		-1	•	1							
	.71 x .08	.91	1.06		-.04		.04							
	22 x 2	24	30,5		-1	•	1	1,5						
	.87 x .08	.94	1.20		-.04		.04	.06						
	28 x 3	26	31,5				-1,5	-0,5	•					
	1.10 x .12	1.02	1.24				-.06	-.02						
	35 x 3	30	36				-1,5	-1	•				1,5	
	1.38 x .12	1.18	1.42				-.06	-.04					.06	
42 x 3	34	40				-1,5		•				1,5		
1.65 x .12	1.34	1.57				-.06						.06		
S	6 x 1	17,5	20,5	•	1	1								
	.24 x .04	.69	.81		.04	.04								
	8 x 1	18,5	21,5	•	1	1,5								
	.31 x .04	.73	.85		.04	.06								
	10 x 1,5	20	24,5	-1	•	1								
	.39 x .06	.79	.96	-.04		.04								
	12 x 1,5	20,5	25	-1	•	1								
	.47 x .06	.81	.98	-.04		.04								
	14 x 2	23	27,5		-0,5	•	1	2						
	.55 x .08	.91	1.08		-.02		.04	.08						
	16 x 2	25	31		-1	•	0,5	1,5						
	.63 x .08	.98	1.22		-.04		.02	.06						
	20 x 2	27,5	33			•	1	2	3					
	.79 x .08	1.08	1.30				.04	.08	.12					
	25 x 3	32	38,5				-1,5	-1	•				1,5	
	.98 x .12	1.26	1.52				-.06	-.04					.06	
	30 x 3	33	41,5				-2	-1	•				2	3,5
	1.18 x .12	1.30	1.63				-.08	-.04					.08	.14
38 x 3	37,5	48					-0,5	•				1,5	3,5	
1.50 x .12	1.48	1.89					-.02					.06	.14	



Assembly Instructions for 24° Weld Cones with O-Ring

1. Tube Preparation

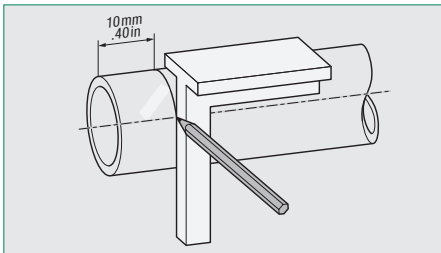

Saw off tube in right angle and at least 10 mm / .40 in from the cut made by the tube manufacturer / supplier in order to avoid failures caused during shipment.

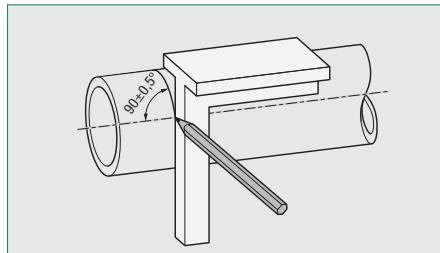

A maximum angular deviation / tolerance of $\pm 0,5^\circ$ relative to the tube axis is permissible.

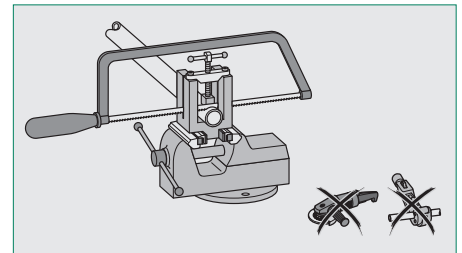

Only use proper tube sawing machinery or equipment. Do not use tube cutters or grinders as this may result in unwanted angled cuts and cause severe burring.

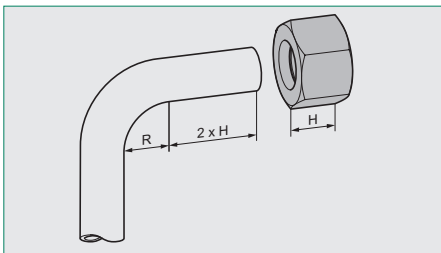

For tube bends, the length of the straight section of the tube end to the start of the bending radius has to be twice the height of the union nut.

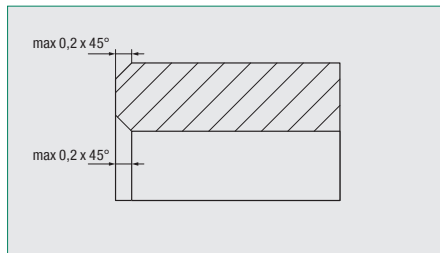

Slightly deburr inside and outside of the tube end (max 0,2 x 45°). The assembly area of the tube has to be free of contamination, chips and paint.

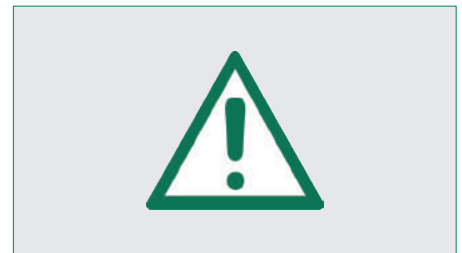

Please note: Improperly prepared and contaminated tubes will affect the service life of the connection and may result in leakage.

2. Assembly Preparation and Welding

Place the union nut on the weld cone.

Remove the o-ring from the front end of the weld cone before welding (usually supplied separately).

Weld the weld cone and the tube end according to any applicable guidelines for welding.

The user is fully responsible for the quality of the welding work.

Descal the welded area and clean the o-ring groove.

Assemble the o-ring and make sure that it is located in the groove of the weld cone without being twisted.

Lubricate the o-ring of the weld cone (e.g. using mineral-oil based hydraulic fluid HLP32). Do not use lubricating grease!

Immediately proceed with the assembly in order to avoid exposure to contamination.

3. Assembly with the Fitting Body

Carefully insert the weld cone into the 24° taper of the fitting body.

Tighten the union nut until the noticeable increase in force.

Then finish the assembly with another approximately 1/3 a turn (120°) beyond this point.

A marking line applied on the union nut and the fitting body makes it easier to indicate the sufficient tightening turns.

4. Repeated Assembly

For repeated assembly, the union nut has to be tightened using exactly the same force as for the original assembly.

The o-ring has to be checked for possible damages and, if necessary, replaced prior to the re-assembly.



Assembly Instructions for 24° Weld Cones with O-Ring

Calculation Dimensions

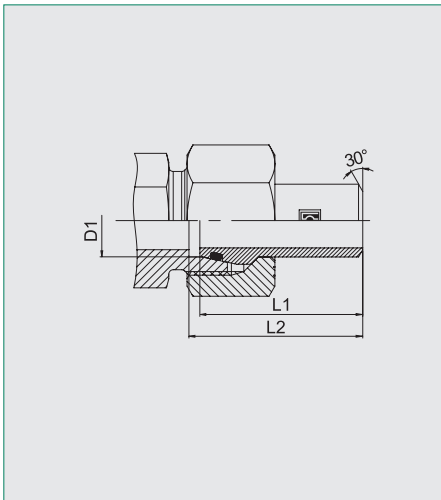

Series	Tube OD		Dimensions				
	D1 (mm)	(in)	L1 (mm)	(in)	L2 (mm)	(in)	
L	6	.24	31	1.22	32	1.26	
	8	.31	31	1.22	32	1.26	
	10	.39	32,5	1.28	33,5	1.32	
	12	.47	32,5	1.28	33,5	1.32	
	15	.59	35	1.38	36	1.42	
	18	.71	36	1.42	37	1.46	
	22	.87	38,5	1.52	39,5	1.56	
	28	1.10	41,5	1.63	42,5	1.67	
	35	1.38	47	1.85	49,5	1.95	
	42	1.65	47	1.85	50	1.97	
	S	6	.24	31	1.22	32	1.26
		8	.31	31	1.22	32	1.26
10		.39	32,5	1.28	33,5	1.32	
12		.47	32,5	1.28	33,5	1.32	
14		.55	38,5	1.52	39,5	1.56	
16		.63	39	1.54	41	1.61	
20		.79	44,5	1.75	47	1.85	
25		.98	49,5	1.95	53,5	2.11	
30		1.18	52,5	2.07	57,5	2.26	
38		1.50	56,5	2.22	64,5	2.54	



Assembly Instructions for Tube Fittings with 24° Taper and O-Ring

1. Assembly Preparation

Make sure that the o-ring is located in the groove of the taper without being twisted.

Lubricate the o-ring of the taper fitting (e.g. using mineral-oil based hydraulic fluid HLP32). Do not use lubricating grease!

Immediately proceed with the assembly in order to avoid exposure to contamination.

2. Assembly with the Fitting Body

Keep the taper fitting aligned and carefully insert it into the 24° taper of the fitting body.

Tighten the wire-pin nut until the noticeable increase in force, and then finish the assembly with another approximately 1/3 a turn (120°) beyond this point.

Important: Always use a spanner to hold the fitting body during the assembly procedure.

A marking line applied on the nut and the fitting body makes it easier to indicate the sufficient tightening turns.

Assembly Instructions for Tube Fittings with Standpipe

1. Assembly Preparation

Standpipe fittings are always supplied with factory-assembled cutting rings and union nuts.

2. Assembly with the Fitting Body

Keep the fitting with standpipe aligned and carefully insert it into the 24° taper of the fitting body.

Tighten the wire-pin nut until the noticeable increase in force, and then finish the assembly with another approximately 1/12 a turn (30°) beyond this point.

Important: Always use a spanner to hold the fitting body during the assembly procedure.

A marking line applied on the nut and the fitting body makes it easier to indicate the sufficient tightening turns.



Assembly Instructions for Tube Fittings with Male Threaded Stud

Tightening Torques

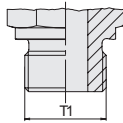
Metallic Sealing Edge

Metric Parallel Thread
DIN 3852-1 (Form B) / ISO 9974-3 (Type B)
Whitworth Parallel Pipe Thread
DIN 3852-2 (Form B) / ISO 1179-4 (Type B)

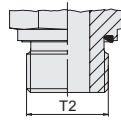
Profile Sealing Ring

Metric Parallel Thread
ISO 9974-2 (Type E)
Whitworth Parallel Pipe Thread
ISO 1179-2 (Type E)

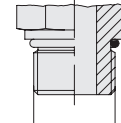
**O-Ring without Retaining Ring
(Non-Adjustable)**

Metric Parallel Thread
ISO 6149-2 /-3

Series	Tube OD (mm/in) D1	Thread T1		Thread T2				Thread T3			
		Metallic Sealing Edge	Torque (N·m) ca.	Metallic Sealing Edge	Torque (^{Nm} / _{ft·lb}) ca.	Profile Sealing Ring	Torque (^{Nm} / _{ft·lb}) ca.	Profile Sealing Ring	Torque (^{Nm} / _{ft·lb}) ca.	O-Ring	Torque (^{Nm} / _{ft·lb}) ca.
L	6	M 10 x 1	18	G 1/8	18	M 10 x 1	18	G 1/8	18	M 10 x 1	15
	.24		13.32				13.32		13.32		11.1
	8	M 12 x 1,5	30	G 1/4	35	M 12 x 1,5	25	G 1/4	30	M 12 x 1,5	25
	.31		22.2				25.9		18.5		22.2
	10	M 14 x 1,5	45	G 1/4	35	M 14 x 1,5	45	G 1/4	45	M 14 x 1,5	35
	.39		33.3				25.9		33.3		33.3
	12	M 16 x 1,5	65	G 3/8	70	M 16 x 1,5	55	G 3/8	70	M 16 x 1,5	40
	.47		48.1				51.8		40.7		51.8
	15	M 18 x 1,5	80	G 1/2	110	M 18 x 1,5	70	G 1/2	90	M 18 x 1,5	45
	.59		59.2				81.4		51.8		66.6
	18	M 22 x 1,5	140	G 1/2	110	M 22 x 1,5	125	G 1/2	90	M 22 x 1,5	60
	.71		103.6				81.4		92.5		66.6
	22	M 26 x 1,5 ²	190	G 3/4	180	M 26 x 1,5 ²	180	G 3/4	180	M 27 x 2	100
	.87		140.6				133.2		133.2		133.2
	28	M 33 x 2	330	G 1	330	M 33 x 2	310	G 1	310	M 33 x 2	160
1.10	244.2		244.2				229.4		229.4		118.4
35	M 42 x 2	500	G 1 1/4	540	M 42 x 2	450	G 1 1/4	450	M 42 x 2	210	
1.38		370				399.6		333		333	155.4
42	M 48 x 2	630	G 1 1/2	630	M 48 x 2	540	G 1 1/2	540	M 48 x 2	260	
1.65		466.2				466.2		399.6		399.6	192.4
S	6	M 10 x 1	18	G 1/8	18	M 10 x 1	18	G 1/8	18	M 10 x 1	35
	.24		13.32				13.32		13.32		25.9
	8	M 12 x 1,5	30	G 1/4	35	M 12 x 1,5	25	G 1/4	30	M 12 x 1,5	40
	.31		22.2				25.9		18.5		22.2
	10	M 14 x 1,5	45	G 1/4	35	M 14 x 1,5	45	G 1/4	45	M 14 x 1,5	55
	.39		33.3				25.9		33.3		33.3
	12	M 16 x 1,5	65	G 3/8	70	M 16 x 1,5	55	G 3/8	70	M 16 x 1,5	70
	.47		48.1				51.8		40.7		51.8
	14 ¹	M 18 x 1,5	80	G 1/2	110	M 18 x 1,5	70	G 1/2	90	M 18 x 1,5	
	.55		59.2				81.4		51.8		66.6
	16	M 22 x 1,5	140	G 1/2	110	M 22 x 1,5	125	G 1/2	90	M 22 x 1,5	100
	.63		103.6				81.4		92.5		66.6
	20	M 26 x 1,5 ²	190	G 3/4	180	M 26 x 1,5 ²	180	G 3/4	180	M 27 x 2	170
	.79		140.6				133.2		133.2		133.2
	25	M 33 x 2	330	G 1	330	M 33 x 2	310	G 1	310	M 33 x 2	310
.98	244.2		244.2				229.4		229.4		229.4
30	M 42 x 2	500	G 1 1/4	540	M 42 x 2	450	G 1 1/4	450	M 42 x 2	330	
1.18		370				399.6		333		333	244.2
38	M 48 x 2	630	G 1 1/2	630	M 48 x 2	540	G 1 1/2	540	M 48 x 2	420	
1.50		466.2				466.2		399.6		399.6	310.8

¹ Tube size is no longer covered by the applicable standard.

² M 27 x 2 according to ISO 6149.

Please note: The tightening torques for male threaded studs listed in this catalogue are approximate values with a tolerance of +10% and always refer to original components of the STAUFF Connect range made of steel with the default Zinc/Nickel coating and a steel mating material.

Always apply sufficient lubricant to the contact surfaces of the threads prior to the assembly.

Please contact STAUFF prior to the assembly for recommended tightening torques for use with any mating materials other than Steel!



Assembly Instructions for Banjo Fittings

1. Assembly Preparation

Lubricate the o-ring of the banjo bolt (e.g. using mineral-oil based hydraulic fluid HLP32). Do not use lubricating grease!

Immediately proceed with the assembly in order to avoid exposure to contamination.

2. Assembly with the Fitting Body

Place the external metallic sealing ring or the retaining ring with captive seal on the opposite side of the banjo fitting into the larger bore and center it through the thread for the banjo bolt. Retaining rings with captive seal are additionally centered through the bore in the fitting body – any clearance between the ring and the fitting body is not allowed.

Align the body of the banjo fitting and tighten the banjo bolt with a spanner until the noticeable increase in force (pressure point).

Use a suitable spanner to finish the assembly with either another approximately 1/6 a turn (60°, applicable for retaining rings with captive seal) or 1/4 a turn (90°, applicable for external metallic sealing rings) beyond this point while holding the body of the banjo fitting in position using a second spanner.

Positioning and Orientation of Retaining Rings with Captive Seal

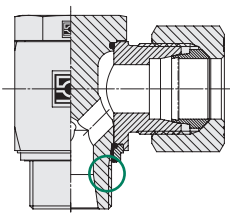

Applicable for RSWND / RSW / RST

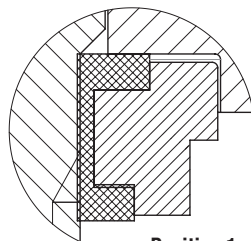

Position 1

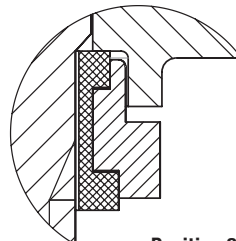

Position 2

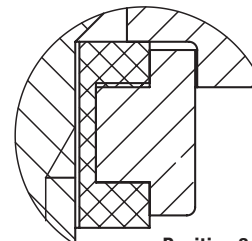

Position 3

Series	Tube OD (mm/in)	Thread	Position
L	6	G 1/8	2
	.24		
	8	G 1/4	2
	10	G 1/4	2
	12	G 3/8	1
	15	G 1/2	1
	18	G 1/2	1
	22	G 3/4	1
28	G 1	1	
			1.10
35	G 1 1/4	1	
			1.38
42	G 1 1/2	1	
			1.65
S	6	G 1/4	2
	.24		
	8	G 1/4	2
	10	G 3/8	1
	12	G 3/8	1
	14	G 1/2	1
	16	G 1/2	1
	20	G 3/4	1
25	G 1	1	
			.98
30	G 1 1/4	1	
			1.18
38	G 1 1/2	1	
			1.50

Series	Tube OD (mm/in)	Thread	Position
L	6	M 10x1	2
	.24		
	8	M 12x1,5	3
	10	M 14x1,5	2
	12	M 16x1,5	1
	15	M 18x1,5	1
	18	M 22x1,5	1
	22	M 26x1,5	1
28	M 33x2	1	
			1.10
35	M 42x2	1	
			1.38
42	M 48x2	1	
			1.65
S	6	M 12x1,5	3
	.24		
	8	M 14x1,5	2
	10	M 16x1,5	1
	12	M 18x1,5	1
	14	M 20x1,5	1
	16	M 22x1,5	1
	20	M 27x2	1
25	M 33x2	1	
			.98
30	M 42x2	1	
			1.18
38	M 48x2	1	
			1.50



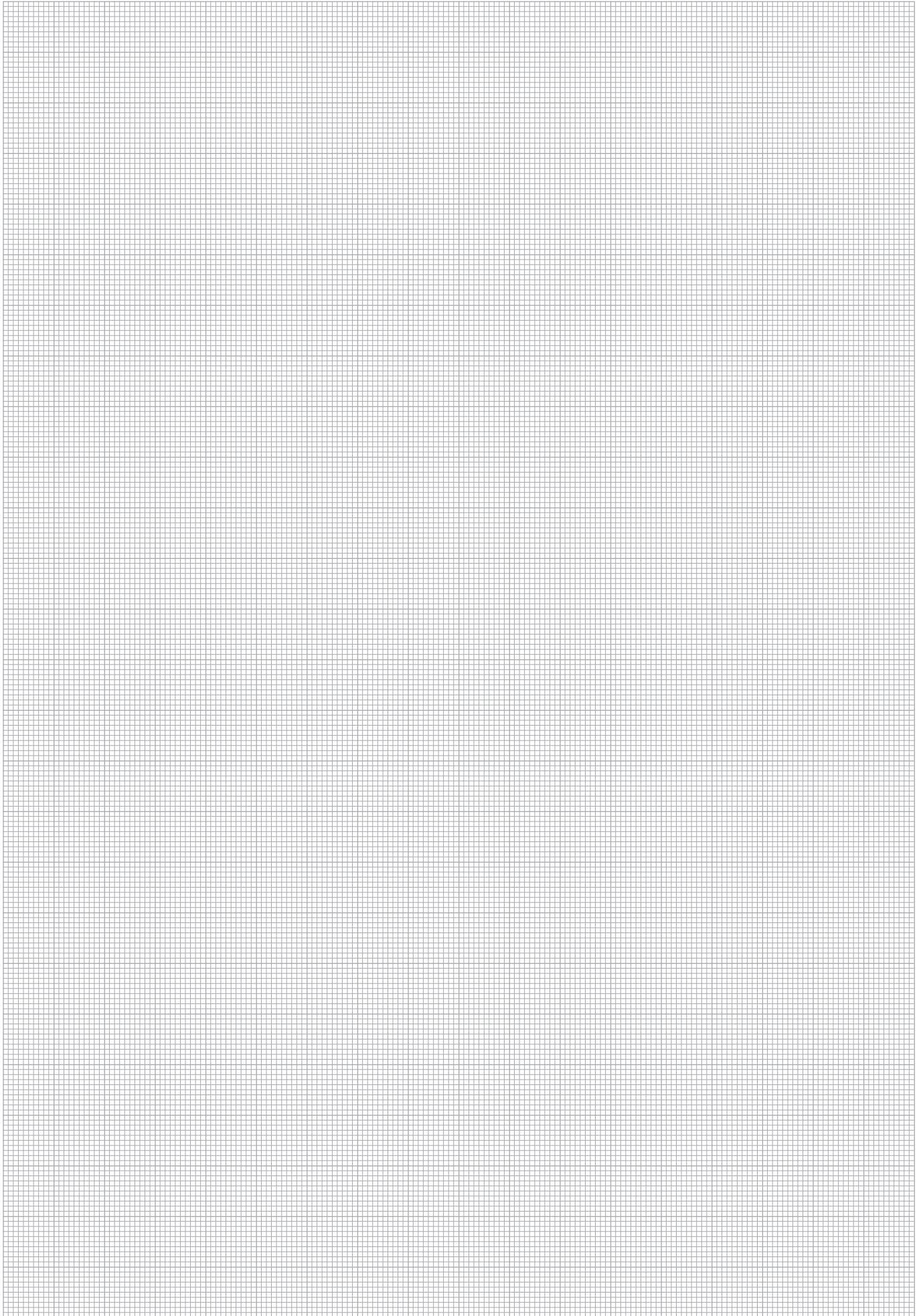

Q





Tube Fitting Materials and Surface Finishings	280
Elastomer Seal Materials	281
Pressure and Temperature Ratings	282
Pressure Reduction Factors	283
Calculated Design / Burst Pressures for Tube (bar)	284
Calculated Design / Burst Pressures for Tube (PSI)	286
Port Dimensions for Fittings with Male Threaded Stud	288
Dimensions of the 24° Conical Bore / Union Nut	292
Standard Threads and Widths Across Flats for Fittings with Male Threaded Stud	293
Certificates and Approvals	294



Tube Fitting Materials and Surface Finishings

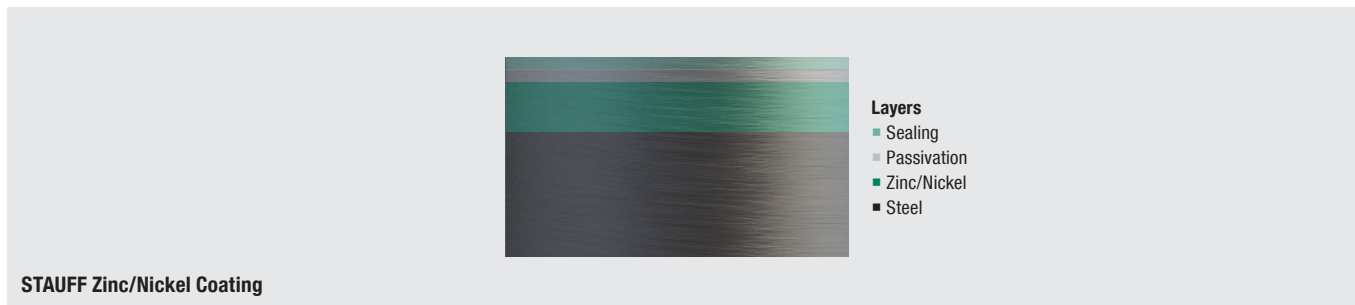

Fitting bodies of the STAUFF Connect range are usually machined from drawn or forged steel in accordance with DIN 3859-1 (Technical Specification for Tube Fittings).

Union nuts are either cold-pressed or hot-pressed.

Unless otherwise stated, all metal parts of the STAUFF Connect range of tube fittings are made of Steel with standard Zinc/Nickel coating (material code: W3), that offers excellent surface protection far beyond the market standard.

One of the few exceptions, weld fittings are made of Steel, phosphated (material code: W2).

Alternative surface coatings are available upon request.

Do not hesitate to contact STAUFF for further information.

Main Advantages of the STAUFF Zinc/Nickel Coating

- Premium long-life surface protection against corrosion with more than 1200 hours resistance to red rust / base metal corrosion in the salt-spray test according to DIN EN ISO 9227
- Free of hexavalent chrome Cr(VI)
- ELV compliant according to 2000/53/EC (End of Life Vehicles Directive)
- REACH compliant according to 1907/2006/EC (Registration, Evaluation, Authorisation and Restriction of Chemicals)
- RoHS compliant according to 2002/95/EC (Restrictions of the Use of Hazardous Substances)
- Easily surpassing the requirements of the corrosion protection class K5 (360 hours resistance to white rust / 720 hours resistance to red rust) as defined by the VDMA, the German Engineering Association (VDMA Standard Sheet 24576 „Fluid Power - Requirements and designations for corrosion-protection coatings free of hexavalent chrome“)
- Significantly reduced tendency to corrosion by contact with other metals such as Aluminium and Stainless Steel
- High abrasion resistance due to the ductility / plastic deformability of the coating
- Appealing colour scheme with a bright semi-gloss surface finish – comparable to Stainless Steel
- Surface is paintable with good paint adhesion properties (However, a painting test and, if necessary, degreasing of the surfaces to be painted are highly recommended)
- Little to no risk of triggering allergies, as the Zinc/Nickel base layer with a nickel content of 12-15 % is covered by both a passivation and a sealing layer to avoid the release of nickel and any direct physical contact
- Resistant against all commonly used hydraulic media



Elastomer Seal Materials

Unless otherwise stated, standard elastomer seals are made of NBR (Perbunan®) with a hardness degree of 90 shore A.

Elastomer seals made of NBR (Perbunan® – material code: B) are especially suitable for liquid or gaseous media at operating temperatures that range from -35 °C to +100 °C / -31 °F to +212 °F.

Elastomer seals for applications with higher temperatures or aggressive media, such as FKM/FPM (Viton® – material code: V – operating temperature range from -25 °C to +392 °C / -13 °F to +212 °F) and EPDM (material code: E), are available upon request.

Do not hesitate to contact STAUFF for further information.

The performance of elastomer seals during operation can be negatively affected by various influences. Elastomer seals should be inspected for any kind of damage (cracks, deformation, hardening or softening, swelling, reduced elasticity etc.) or contamination prior to the assembly process and when carrying out service and maintenance work, and should be replaced, if necessary.

Spare seals are available as part of the STAUFF Connect range.

Storage Recommendations

Please observe the following storage recommendations for elastomer seals in accordance with DIN 7716 (Requirements for Storage, Cleaning and Maintenance of Rubber Products):

- Store seals in a dry place, away from draughts, at temperatures not exceeding +25 °C / +77 °F.
- Protect seals from sunlight, ozone and strong artificial lightning during storage.

These recommendations do not only apply for separate elastomer seals, but also for tube fittings with pre-assembled o-rings and seals.

Not following these storage recommendations can cause brittle fracture of elastomer seals and result in leakage!

*Perbunan® is a registered trademark of Lanxess Deutschland GmbH.
Viton® is a registered trademark of DuPont Performance Elastomers L.L.C.*



Pressure and Temperature Ratings

General Information

Unless otherwise stated, all pressure ratings in this product catalogue are indicated in bar and PSI. All temperature ratings are indicated in °C (degree Celsius) and °F (degree Fahrenheit).

Pressure ratings are usually rounded to correspond with standardised pressure ratings, which are internationally recognised and assist to identify and match common sizes of components together.

All tube fittings and other components of the STAUFF Connect range meet or exceed common standardised pressure ratings for mobile and industrial fluid power applications up to nominal pressures of 800 bar / 11600 PSI (depending on series, type and size of the component – pressure reduction factors to be considered).

Pressure ratings are divided into nominal pressures (PN) and permissible operating pressures (PB).

Nominal Pressure (PN)

Nominal pressure (PN) is a term used to describe the pressure that tube fittings and other components are designed to safely withstand, and indicates the maximum operating pressure of tube fittings and other components that should be applied to the component when operating the system under stationary conditions.

During static load tests, burst pressures must be at least 4 times higher than the nominal pressures (safety factor of 4).

Permissible Operating Pressure (PB)

The permissible operating pressure (PB) of a component (as defined in DIN 2401, part 1) is identical to the maximum internal overpressure at regular operating conditions (operating temperature of +120 °C without dynamic loads / pressure peaks) as calculated based on the material in use and considering the permissible operating temperature (TB).

During static load tests, burst pressures must be at least 2,5 times higher than the permissible operating pressures (safety factor of 2,5).

Please note:

The pressure ratings and safety factors as specified are only applicable when strictly following the assembly instructions (e.g. tightening torques for male stud fittings) and only refer to original components of the STAUFF Connect range. Avoid mixing with other brands' products!

If components are exposed to vibrations, dynamic loads or pressure peaks, the pressure ratings must be reduced accordingly in order to keep the same level of safety.

Permissible Operating Temperature (TB)

Unless otherwise stated, the permissible operating temperature (TB) for tube fittings and other components in this product catalogue ranges from -40 °C to +120 °C / -40 °C to +248 °C in accordance with DIN 3859-1 (Technical Specification for Tube Fittings).

Please observe that the permissible operating temperature may differ for tube fittings and other components that use elastomer seals.



Pressure Reduction Factors

Pressure reduction factors (in percent) have to be considered when intending to use the components at operating temperatures exceeding +120 °C / +248 °F.

Calculation Example

Component Straight Fitting FI-G-10S-W3-MS made of Steel with a nominal pressure (PN) rating of 800 bar / 11600 PSI

Temperature +175 °C / +347 °F

Reduction Factor 15 %

Reduced Nominal Pressure $PN = \frac{800 \text{ bar}}{100 \%} \times (100 \% - 15 \%) = 680 \text{ bar}$

$PN = \frac{11600 \text{ PSI}}{100 \%} \times (100 \% - 15 \%) = 9860 \text{ PSI}$

Please note:

When selecting tubes and other components for your system, any additional potential pressure reduction factors stated by the manufacturers / suppliers have to be considered.

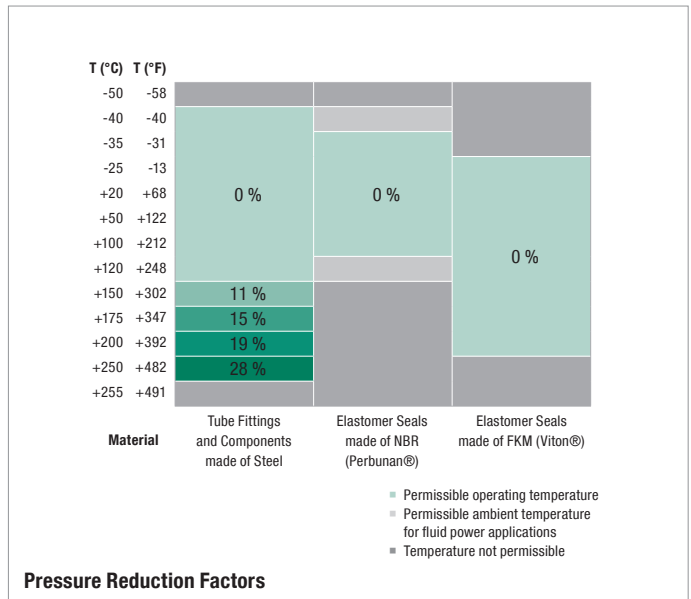

Selection Criteria for Tube

STAUFF recommends to use seamless, cold-drawn and normalized precision steel tubes as specified in DIN EN 10305-4, material E235+N (material number 1.0308+N, formerly St37.4) or material E355 (material number 1.0580, formerly St52.4).

In order to avoid misdeliveries, the tubes have to be ordered from the supplier by specifying the exact outer and inner diameter.

Tube materials and tolerances differing from these recommendations may lead to system faults or leakages and may even result in total breakdowns.

Unless otherwise stated, the pressure / temperature ratings as well as all other operating conditions indicated in this product catalogue do not refer to the actual tube. Specifications made by the respective tube manufacturers / suppliers have to be considered.



Calculated Design / Burst Pressures for Tube (bar)

Tube OD (mm)	Tube ID (mm)	Tube Wall (mm)	STAUFF Nominal pressure (bar)		Calculated Design Pressure (bar) in accordance with DIN 2413 - Load Case I (predominantly static loads, up to +120 °C)			Calculated Design Pressure (bar) in accordance with DIN 2413 - Load Case III (dynamic / pulsating loads, up to +120 °C)			Calculated Burst Pressure (bar) in accordance with ISO 10763		
			Light Series	Heavy Series	Material E235+N	Material E355	Material 1.4571	Material E235+N	Material E355	Material 1.4571	Material E235+N	Material E355	Material 1.4571
6	4,5	0,75	500	800	338	491	368	303	310	256	1116	1525	1346
6	4	1	500	800	450	655	490	391	400	330	1573	2149	1898
6	3	1,5	500	800	675	983	735	551	563	465	2689	3674	3244
6*	2	2	500	800	900	1310	980	692	708	585	4263	5823	5142
6*	1,5	2,25	500	800	1013	1474	1103	757	774	639	5379	7347	6488
8	6	1	500	800	338	491	368	303	310	256	1116	1525	1346
8	5	1,5	500	800	506	737	551	433	443	366	1824	2491	2200
8	4	2	500	800	675	983	735	551	563	465	2689	3674	3244
8*	3	2,5	500	800	844	1228	919	659	673	556	3806	5198	4590
10	8	1	500	800	270	393	294	248	253	209	866	1183	1044
10	7	1,5	500	800	405	590	441	357	365	301	1384	1890	1669
10	6	2	500	800	540	786	588	458	468	386	1982	2707	2391
10	5	2,5	500	800	675	983	735	551	563	465	2689	3674	3244
10*	4	3	500	800	810	1179	882	638	652	539	3555	4856	4288
12	10	1	400	630	225	328	245	209	214	177	707	966	853
12	9	1,5	400	630	338	491	368	303	310	256	1116	1525	1346
12	8	2	400	630	450	655	490	391	400	330	1573	2149	1898
12	7	2,5	400	630	563	819	613	474	484	400	2091	2857	2523
12	6	3	400	630	675	983	735	551	563	465	2689	3674	3244
12*	5	3,5	400	630	823	1180	858	624	638	527	3397	4640	4097
12*	4	4	400	630	940	1348	980	692	708	585	4263	5823	5142
14	12	1		630	193	281	210	181	185	153	598	817	721
14	11	1,5		630	289	421	315	264	270	223	936	1278	1129
14	10	2		630	386	561	420	342	349	289	1306	1783	1575
14	9	2,5		630	482	702	525	415	425	351	1714	2342	2068
14	8	3		630	579	842	630	485	496	410	2171	2966	2619
14	7	3,5		630	705	1011	735	551	563	465	2689	3674	3244
15	13	1	400		180	262	196	170	174	143	555	758	670
15	12	1,5	400		270	393	294	248	253	209	866	1183	1044
15	11	2	400		360	524	392	321	329	271	1203	1644	1452
15	10	2,5	400		450	655	490	391	400	330	1573	2149	1898
15	9	3	400		540	786	588	458	468	386	1982	2707	2391
16	14	1		630	169	246	184	160	163	135	518	708	625
16	13	1,5		630	253	368	276	233	239	197	806	1100	972
16	12	2		630	338	491	368	303	310	256	1116	1525	1346
16	11	2,5		630	422	614	459	370	378	312	1454	1986	1754
16	10	3		630	506	737	551	433	443	366	1824	2491	2200
16	8	4		630	705	1011	735	551	563	465	2689	3674	3244
18	16	1	400		150	218	163	143	146	121	457	624	551
18	15	1,5	400		225	328	245	209	214	177	707	966	853
18	14	2	400		300	437	327	273	279	230	975	1332	1176
18	13	2,5	400		375	546	408	333	341	281	1263	1725	1523
18	12	3	400		450	655	490	391	400	330	1573	2149	1898
18	10	4	400		627	899	653	500	511	422	2281	3115	2751
20	17	1,5		420	203	295	221	190	194	160	631	861	761
20	16	2		420	270	393	294	248	253	209	866	1183	1044
20	15	2,5		420	338	491	368	303	310	256	1116	1525	1346
20	14	3		420	405	590	441	357	365	301	1384	1890	1669
20	13	3,5		420	494	708	515	408	417	345	1671	2283	2016
20	12	4		420	564	809	588	458	468	386	1982	2707	2391
20	10	5		420	705	1011	735	551	563	465	2689	3674	3244

Load case I according to DIN 2413 describes predominantly static loads at temperatures not exceeding +120 °C.
 Load case III according to DIN 2413 describes dynamic / pulsating loads at temperatures not exceeding +120 °C.

For some sizes of thin-walled steel tube, support sleeves are highly recommended and in some case generally required.
 Please see page G11 for selection charts and detailed assembly instructions.



Calculated Design / Burst Pressures for Tube (bar)

Tube OD (mm)	Tube ID (mm)	Tube Wall (mm)	STAUFF Nominal pressure (bar)		Calculated Design Pressure (bar) in accordance with DIN 2413 - Load Case I (predominantly static loads, up to +120 °C)			Calculated Design Pressure (bar) in accordance with DIN 2413 - Load Case III (dynamic / pulsating loads, up to +120 °C)			Calculated Burst Pressure (bar) in accordance with ISO 10763		
			Light Series	Heavy Series	Material E235+N	Material E355	Material 1.4571	Material E235+N	Material E355	Material 1.4571	Material E235+N	Material E355	Material 1.4571
22	20	1	250		123	179	134	118	121	100	370	505	446
22	19	1,5	250		184	268	200	173	177	146	569	777	686
22	18	2	250		245	357	267	227	232	192	779	1064	939
22	17	2,5	250		307	447	334	278	285	235	1000	1366	1207
22	16	3	250		368	536	401	328	335	277	1236	1688	1490
22	15	3,5	250		449	643	468	376	384	317	1486	2030	1792
22	14	4	250		513	735	535	422	431	356	1754	2396	2115
25	22	1,5		420	162	236	176	154	157	130	496	678	598
25	21	2		420	216	314	235	201	206	170	676	924	816
25	20	2,5		420	270	393	294	248	253	209	866	1183	1044
25	19	3		420	324	472	353	292	299	247	1065	1455	1284
25	18	3,5		420	395	566	412	336	343	283	1275	1741	1537
25	17	4		420	451	647	470	378	386	319	1496	2044	1805
25	16	4,5		420	508	728	529	418	428	353	1732	2365	2089
25	15	5		420	564	809	588	458	468	386	1982	2707	2391
28	25	1,5	250		145	211	158	138	141	117	440	601	530
28	24	2	250		193	281	210	181	185	153	598	817	721
28	23	2,5	250		241	351	263	223	228	188	763	1043	921
28	22	3	250		289	421	315	264	270	223	936	1278	1129
28	21	3,5	250		353	506	368	303	310	256	1116	1525	1346
28	20	4	250		403	578	420	342	349	289	1306	1783	1575
30	26	2		420	180	262	196	170	174	143	555	758	670
30	25	2,5		420	225	328	245	209	214	177	707	966	853
30	24	3		420	270	393	294	248	253	209	866	1183	1044
30	23	3,5		420	329	472	343	285	291	241	1031	1408	1243
30	22	4		420	376	539	392	321	329	271	1203	1644	1452
30	20	5		420	470	674	490	391	400	330	1573	2149	1898
30	18	6		420	564	809	588	458	468	386	1982	2707	2391
35	32	1,5	250		121	173	126	111	114	94	348	475	419
35	31	2	250		161	231	168	147	150	124	471	643	568
35	30	2,5	250		201	289	210	181	185	153	598	817	721
35	29	3	250		242	347	252	215	220	181	730	997	880
35	27	4	250		322	462	336	280	286	236	1007	1375	1215
35	25	5	250		403	578	420	342	349	289	1306	1783	1575
38	34	2		420	148	213	155	136	139	115	432	589	521
38	33	2,5		420	186	266	193	168	171	142	547	748	660
38	32	3		420	223	319	232	199	203	168	667	911	804
38	30	4		420	297	426	309	260	265	219	917	1253	1106
38	28	5		420	371	532	387	318	325	268	1185	1619	1429
38	26	6		420	445	639	464	373	382	315	1472	2011	1776
38	24	7		420	519	745	542	427	436	360	1783	2436	2151
38	22	8		420	594	851	619	478	488	404	2121	2897	2558
42	39	1,5	250		101	144	105	93	96	79	288	393	347
42	38	2	250		134	193	140	123	126	104	388	530	468
42	37	2,5	250		168	241	175	153	156	129	492	672	593
42	36	3	250		201	289	210	181	185	153	598	817	721
42	34	4	250		269	385	280	237	242	200	820	1120	989
42	32	5	250		336	481	350	290	297	245	1041	1441	1273

All figures are based on calculations carried out in accordance with DIN 2413 and ISO 10763.

They are intended to assist the user in the pre-selection of the correct tube only, and do not discharge the obligation to carry out own calculations in consideration of the actual conditions of use.

DIN 2413 does not apply to tube sizes marked by * (where D1/D2 > 2).



Calculated Design / Burst Pressures for Tube (PSI)

Tube OD (in)	Tube ID (in)	Tube Wall (in)	STAUFF Nominal pressure (bar)	Calculated Design Pressure (PSI) in accordance with DIN 2413 - Load Case I (primary static loads, up to +248 °F)			Calculated Design Pressure (PSI) in accordance with DIN 2413 - Load Case III (dynamic loads, up to +248 °F)			Calculated Burst Pressure (PSI) in accordance with ISO 10763			
				Light Series	Heavy Series	Material E235+N	Material E355	Material 1.4571	Material E235+N	Material E355	Material 1.4571	Material E235+N	Material E355
D1	D2	S											
.24	.18	.03	7252	11603	4901	7120	5337	4394	4495	3713	16182	22113	19522
.24	.16	.04	7252	11603	6525	9498	7107	5670	5800	4786	22809	31161	27529
.24	.12	.06	7252	11603	9788	14254	10660	7990	8164	6744	38991	53273	47051
.24*	.08	.08	7252	11603	13050	18995	14214	10034	10266	8485	61814	84434	74580
.24*	.06	.09	7252	11603	14689	21373	15998	10977	11223	9268	77996	106532	94102
.31	.24	.04	7252	11603	4901	7120	5337	4394	4495	3713	16182	22113	19522
.31	.20	.06	7252	11603	7337	10687	7992	6279	6424	5308	26448	36120	31909
.31	.16	.08	7252	11603	9788	14254	10660	7990	8164	6744	38991	53273	47051
.31*	.12	.10	7252	11603	12238	17806	13329	9556	9759	8064	55187	75371	66573
.39	.31	.04	7252	11603	3915	5699	4264	3596	3669	3031	12557	17154	15142
.39	.28	.06	7252	11603	5873	8555	6396	5177	5293	4366	20068	27405	24207
.39	.24	.08	7252	11603	7830	11397	8528	6641	6786	5599	28739	39252	34679
.39	.20	.10	7252	11603	9788	14254	10660	7990	8164	6744	38991	53273	47051
.39*	.16	.12	7252	11603	11745	17096	12793	9251	9454	7818	51548	70412	62193
.47	.39	.04	5802	9138	3263	4756	3553	3031	3103	2567	10252	14007	12372
.47	.35	.06	5802	9138	4901	7120	5337	4394	4495	3713	16182	22113	19522
.47	.31	.08	5802	9138	6525	9498	7107	5670	5800	4786	22809	31161	27529
.47	.28	.10	5802	9138	8164	11876	8891	6873	7018	5802	30320	41427	36594
.47	.24	.12	5802	9138	9788	14254	10660	7990	8164	6744	38991	53273	47051
.47*	.20	.14	5802	9138	11934	17110	12444	9048	9251	7644	49257	67280	59423
.47*	.16	.16	5802	9138	13630	19546	14214	10034	10266	8485	61814	84434	74580
.55	.47	.04		9138	2799	4075	3046	2625	2683	2219	8671	11847	10457
.55	.43	.06		9138	4191	6105	4569	3828	3915	3234	13572	18531	16375
.55	.39	.08		9138	5597	8135	6092	4959	5061	4192	18937	25854	22844
.55	.35	.10		9138	6989	10179	7615	6018	6163	5091	24853	33959	29994
.55	.31	.12		9138	8396	12209	435	7033	7192	5947	31480	43007	37986
.55	.28	.14		9138	10223	14660	10660	7990	8164	6744	38991	53273	47051
.59	.51	.04	5802		2610	3799	2843	2465	2523	2074	8048	10991	9718
.59	.47	.06	5802		3915	5699	4264	3596	3669	3031	12557	17154	15142
.59	.43	.08	5802		5220	7598	5686	4655	4771	3931	17444	23838	21060
.59	.39	.10	5802		6525	9498	7107	5670	5800	4786	22809	31161	27529
.59	.35	.12	5802		7830	11397	8528	6641	6786	5599	28739	39252	34679
.63	.55	.04		9138	2451	3567	2669	2320	2364	1958	7511	10266	9065
.63	.51	.06		9138	3669	5336	4003	3379	3466	2857	11687	15950	14098
.63	.47	.08		9138	4901	7120	5337	4394	4495	3713	16182	22113	19522
.63	.43	.10		9138	6119	8903	6657	5365	5481	4525	21083	28797	25440
.63	.39	.12		9138	7337	10687	7992	6279	6424	5308	26448	36120	31909
.63	.31	.16		9138	10223	14660	10660	7990	8164	6744	38991	53273	47051
.71	.63	.04	5802		2175	3161	2364	2074	2117	1755	6627	9048	7992
.71	.59	.06	5802		3263	4756	3553	3031	3103	2567	10252	14007	12372
.71	.55	.08	5802		4350	6337	4743	3959	4046	3336	14138	19314	17057
.71	.51	.10	5802		5438	7917	5918	4829	4945	4076	18314	25013	22090
.71	.47	.12	5802		6525	9498	7107	5670	5800	4786	22809	31161	27529
.71	.39	.16	5802		9092	13036	9471	7250	7410	6121	33075	45168	39901
.79	.67	.06		6092	2944	4278	3205	2755	2813	2321	9150	12485	11038
.79	.63	.08		6092	3915	5699	4264	3596	3669	3031	12557	17154	15142
.79	.59	.10		6092	4901	7120	5337	4394	4495	3713	16182	22113	19522
.79	.55	.12		6092	5873	8555	6396	5177	5293	4366	20068	27405	24207
.79	.51	.14		6092	7163	10266	7470	5916	6047	5004	24230	33104	29240
.79	.47	.16		6092	8178	11731	8528	6641	6786	5599	28739	39252	34679
.79	.39	.20		6092	10223	14660	10660	7990	8164	6744	38991	53273	47051

Load case I according to DIN 2413 describes predominantly static loads at temperatures not exceeding +248 °F.
 Load case III according to DIN 2413 describes dynamic / pulsating loads at temperatures not exceeding +248 °F.

For some sizes of thin-walled steel tube, support sleeves are highly recommended and in some case generally required.
 Please see page G11 for selection charts and detailed assembly instructions.



Calculated Design / Burst Pressures for Tube (PSI)

Tube OD (in)	Tube ID (in)	Tube Wall (in)	STAUFF Nominal pressure (bar)	Calculated Design Pressure (PSI) in accordance with DIN 2413 - Load Case I (primary static loads, up to +248 °F)			Calculated Design Pressure (PSI) in accordance with DIN 2413 - Load Case III (dynamic loads, up to +248 °F)			Calculated Burst Pressure (PSI) in accordance with ISO 10763			
				Light Series	Heavy Series	Material E235+N	Material E355	Material 1.4571	Material E235+N	Material E355	Material 1.4571	Material E235+N	Material E355
.87	.79	.04	3626		1784	2596	1944	1711	1755	1450	5365	7323	6469
.87	.75	.06	3626		2668	3886	2901	2509	2567	2118	8251	11267	9950
.87	.71	.08	3626		3553	5177	3873	3292	3364	2785	11296	15428	13619
.87	.67	.10	3626		4452	6482	4844	4031	4133	3408	14500	19807	17506
.87	.63	.12	3626		5336	7772	5816	4756	4858	4018	17922	24476	21611
.87	.59	.14	3626		6511	9324	6788	5452	5568	4598	21547	29435	25991
.87	.55	.16	3626		7439	10658	7760	6119	6250	5163	25433	34742	30676
.98	.87	.06		6092	2349	3422	2553	2233	2277	1886	7192	9831	8673
.98	.83	.08		6092	3132	4553	3408	2915	2987	2466	9802	13398	11835
.98	.79	.10		6092	3915	5699	4264	3596	3669	3031	12557	17154	15142
.98	.75	.12		6092	4698	6844	5120	4234	4336	3582	15443	21098	18623
.98	.71	.14		6092	5728	8207	5976	4872	4974	4105	18488	25245	22293
.98	.67	.16		6092	6540	9382	6817	5481	5597	4627	21692	29638	26180
.98	.63	.18		6092	7366	10556	7673	6061	6206	5120	25114	34293	30299
.98	.59	.20		6092	8178	11731	8528	6641	6786	5599	28739	39252	34679
1.10	.98	.06	3626		2103	3060	2292	2001	2045	1697	6380	8715	7687
1.10	.94	.08	3626		2799	4075	3046	2625	2683	2219	8671	11847	10457
1.10	.91	.10	3626		3495	5090	3815	3234	3306	2727	11064	15124	13358
1.10	.87	.12	3626		4191	6105	4569	3828	3915	3234	13572	18531	16375
1.10	.83	.14	3626		5119	7337	5337	4394	4495	3713	16182	22113	19522
1.10	.79	.16	3626		5844	8381	6092	4959	5061	4192	18937	25854	22844
1.18	1.02	.08		6092	2610	3799	2843	2465	2523	2074	8048	10991	9718
1.18	.98	.10		6092	3263	4756	3553	3031	3103	2567	10252	14007	12372
1.18	.94	.12		6092	3915	5699	4264	3596	3669	3031	12557	17154	15142
1.18	.91	.14		6092	4771	6844	4975	4133	4220	3495	14950	20416	18028
1.18	.87	.16		6092	5452	7816	5686	4655	4771	3931	17444	23838	21060
1.18	.79	.20		6092	6815	9773	7107	5670	5800	4786	22809	31161	27529
1.18	.71	.24		6092	8178	11731	8528	6641	6786	5599	28739	39252	34679
1.38	1.26	.06	3626		1755	2509	1828	1610	1653	1363	5046	6888	6077
1.38	1.22	.08	3626		2335	3350	2437	2132	2175	1798	6830	9324	8238
1.38	1.18	.10	3626		2915	4191	3046	2625	2683	2219	8671	11847	10457
1.38	1.14	.12	3626		3509	5032	3655	3118	3190	2625	10585	14457	12764
1.38	1.06	.16	3626		4669	6699	4873	4060	4147	3423	14602	19938	17622
1.38	.98	.20	3626		5844	8381	6092	4959	5061	4192	18937	25854	22844
1.50	1.34	.08		6092	2146	3089	2248	1972	2016	1668	6264	8541	7557
1.50	1.30	.10		6092	2697	3857	2799	2436	2480	2060	7932	10846	9573
1.50	1.26	.12		6092	3234	4626	3365	2886	2944	2437	9672	13210	11661
1.50	1.18	.16		6092	4307	6177	4482	3770	3843	3176	13297	18169	16041
1.50	1.10	.20		6092	5380	7714	5613	4611	4713	3887	17183	23476	20726
1.50	1.02	.24		6092	6453	9266	6730	5409	5539	4569	21344	29160	25759
1.50	.94	.28		6092	7526	10803	7861	6192	6322	5221	25854	35322	31198
1.50	.87	.31		6092	8613	12340	8978	6931	7076	5860	30755	42007	37101
1.65	1.54	.06	3626		1465	2088	1523	1349	1392	1146	4176	5699	5033
1.65	1.50	.08	3626		1943	2799	2031	1784	1827	1508	5626	7685	6788
1.65	1.46	.10	3626		2436	3495	2538	2219	2262	1871	7134	9744	8601
1.65	1.42	.12	3626		2915	4191	3046	2625	2683	2219	8671	11847	10457
1.65	1.34	.16	3626		3901	5583	4061	3437	3509	2901	11890	16240	14344
1.65	1.26	.20	3626		4872	6975	5076	4205	4307	3553		20895	18464

All figures are based on calculations carried out in accordance with DIN 2413 and ISO 10763.

They are intended to assist the user in the pre-selection of the correct tube only, and do not discharge the obligation to carry out own calculations in consideration of the actual conditions of use.

DIN 2413 does not apply to tube sizes marked by * (where D1/D2 > 2).



Port Dimensions for Fittings with Male Threaded Stud

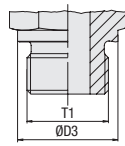

Metallic Sealing Edge

Metric Parallel Thread
DIN 3852-1 (Form B) / ISO 9974-3 (Type B)
Whitworth Parallel Pipe Thread
DIN 3852-2 (Form B) / ISO 1179-4 (Type B)

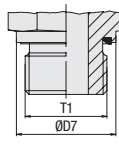

Profile Sealing Ring

Metric Parallel Thread
ISO 9974-2 (Type E)
Whitworth Parallel Pipe Thread
ISO 1179-2 (Type E)

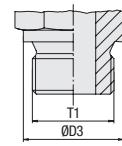

Sealing Surface for Gasket (DIN 7603)

Metric Parallel Thread
DIN 3852-1 (Form A)
Whitworth Parallel Pipe Thread
DIN 3852-2 (Form A)

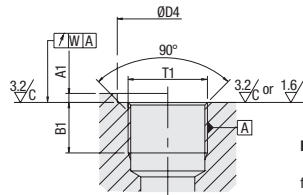

Port (Parallel Thread)

for Male Studs with Metric Parallel Thread
DIN 3852-1 (Form X) / ISO 9974-1
for Male Studs with Whitworth Parallel Pipe Thread
DIN 3852-2 (Form X) / ISO 1179-1

Dimensions

Thread T1 ¹	D3	D7 _{-0.2}	D4 small _{min}	D4 wide _{min}	A1 _{max}	B1 _{min}	W
M 8 x 1	12 .47		13 .51	17 .67	1 .04	8 .31	0,1 .0039
M 10 x 1	14 .55	13,9 .55	15 .59	20 .79	1 .04	8 .31	0,1 .0039
M 12 x 1,5	17 .67	16,9 .67	18 .71	25 .98	1,5 .06	12 .47	0,1 .0039
M 14 x 1,5	19 .75	18,9 .74	20 .79	25 .98	1,5 .06	12 .47	0,1 .0039
M 16 x 1,5	21 .83	21,9 .86	23 .91	28 1.10	1,5 .06	12 .47	0,1 .0039
M 18 x 1,5	23 .91	23,9 .94	25 .98	30 1.18	2 .08	12 .47	0,1 .0039
M 20 x 1,5	24 .94	25,9 1.02	27 1.06	34 1.34	2 .08	14 .55	0,1 .0039
M 22 x 1,5	27 1.06	26,9 1.06	28 1.10	34 1.34	2,5 .10	14 .55	0,1 .0039
M 26 x 1,5	31 1.22	31,9 1.26	33 1.30	42 1.65	2,5 .10	16 .63	0,2 .0079
M 27 x 2	32 1.26	31,9 1.26	33 1.30	42 1.65	2,5 .10	16 .63	0,2 .0079
M 33 x 2	39 1.54	39,9 1.57	41 1.61	47 1.85	2,5 .10	18 .71	0,2 .0079
M 42 x 2	49 1.93	49,9 1.96	51 2.01	58 2.28	2,5 .10	20 .79	0,2 .0079
M 48 x 2	55 2.17	54,9 2.16	56 2.20	65 2.56	2,5 .10	22 .87	0,2 .0079
G 1/8 A	14 .55	13,9 .55	15 .59	19 .75	1 .04	8,5 .33	0,1 .0039
G 1/4 A	18 .71	18,9 .74	20 .79	25 .98	1,5 .06	12,5 .49	0,1 .0039
G 3/8 A	22 .87	21,9 .86	23 .91	28 1.10	2 .08	12,5 .49	0,1 .0039
G 1/2 A	26 1.02	26,9 1.06	28 1.10	34 1.34	2,5 .10	15 .59	0,1 .0039
G 3/4 A	32 1.26	31,9 1.26	33 1.30	42 1.65	2,5 .10	16,5 .65	0,2 .0079
G 1 A	39 1.54	39,9 1.57	41 1.61	47 1.85	2,5 .10	19 .75	0,2 .0079
G 1 1/4 A	49 1.93	49,9 1.96	51 2.01	58 2.28	2,5 .10	21,1 .83	0,2 .0079
G 1 1/2 A	55 2.17	54,9 2.16	56 2.20	65 2.56	2,5 .10	22,5 .89	0,2 .0079

¹ Appendix A in the thread description does not apply to (female) threaded ports.



Port Dimensions for Fittings with Male Threaded Stud

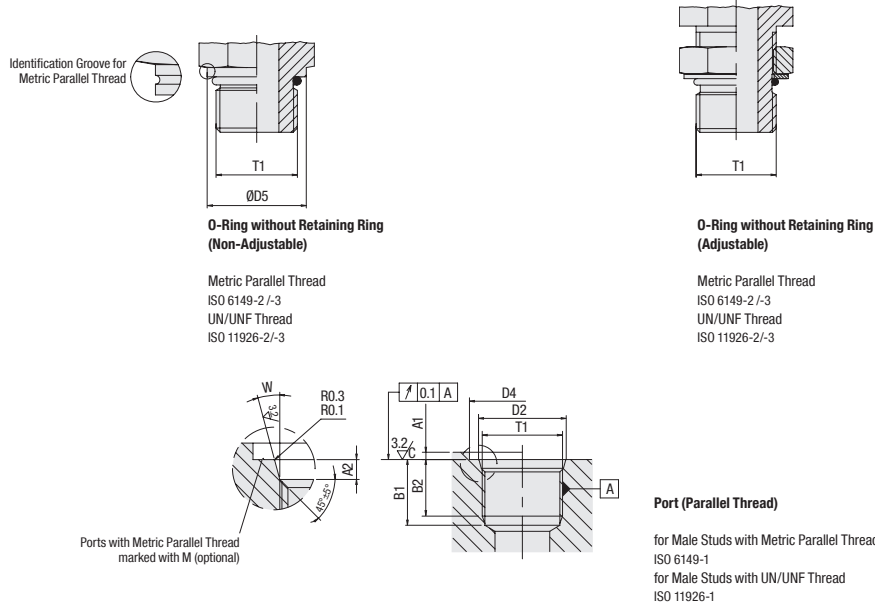

Dimensions

(mm/in)

Thread T1 ¹	D5	D4 small _{min}	D4 wide _{min}	D2 _{+0.1 (UN/UNF: ±0.05)}	A1 _{max}	A2 _{+0.4}	B1 _{min}	B2 _{min}	W _{±1*}
M 8 x 1	11,8	14	17	9,1	1	1,6	11,5	10	12
	.46	.55	.67	.36	.04	.06	.45	.39	.47
M 10 x 1	13,8	16	20	11,1	1	1,6	11,5	10	12
	.54	.63	.79	.44	.04	.06	.45	.39	.47
M 12 x 1,5	16,8	19	23	13,8	1,5	2,4	14	11,5	15
	.66	.75	.91	.54	.06	.09	.55	.45	.59
M 14 x 1,5	18,8	21	25	15,8	1,5	2,4	14	11,5	15
	.74	.83	.98	.62	.06	.09	.55	.45	.59
M 16 x 1,5	21,8	24	28	17,8	1,5	2,4	15,5	13	15
	.86	.94	1.10	.70	.06	.09	.61	.51	.59
M 18 x 1,5	23,8	26	30	19,8	2	2,4	17	14,5	15
	.94	1.02	1.18	.78	.08	.09	.67	.57	.59
M 22 x 1,5	26,8	29	33	23,8	2	2,4	18	15,5	15
	1.06	1.14	1.30	.94	.08	.09	.71	.61	.59
M 27 x 2	31,8	34	40	29,4	2	3,1	22	19	15
	1.25	1.34	1.57	1.16	.08	.12	.87	.75	.59
M 33 x 2	40,8	43	49	35,4	2,5	3,1	22	19	15
	1.61	1.69	1.93	1.39	.10	.12	.87	.75	.59
M 42 x 2	49,8	52	58	44,4	2,5	3,1	22,5	19,5	15
	1.96	2.05	2.28	1.75	.10	.12	.89	.77	.59
M 48 x 2	54,8	57	63	50,4	2,5	3,1	25	22	15
	2.16	2.24	2.48	1.98	.10	.12	.98	.87	.59
7/16-20 UNF-2A	14,4	21		12,45	1,6	2,4	14	11,5	12
	.57	.83		.49	.06	.09	.55	.45	.47
1/2-20 UNF-2A	16	23		14,05	1,6	2,4	14	11,5	12
	.63	.91		.55	.06	.09	.55	.45	.47
9/16-18 UNF-2A	17,6	25		15,7	1,6	2,5	15,5	12,7	12
	.69	.98		.62	.06	.10	.61	.50	.47
3/4-16 UNF-2A	21,8	30		20,65	2,4	2,5	17,5	14,3	15
	.86	1.18		.81	.09	.10	.69	.56	.59
7/8-14 UNF-2A	25,5	34		24	2,4	2,5	20	16,7	15
	1.00	1.34		.94	.09	.10	.79	.66	.59
1 1/16-12 UN-2A	31,9	41		29,2	2,4	3,3	23	19	15
	1.26	1.61		1.15	.09	.13	.91	.75	.59
1 5/16-12 UN-2A	38,2	49		35,55	3,2	3,3	23	19	15
	1.50	1.93		1.40	.13	.13	.91	.75	.59
1 5/8-12 UN-2A	47,7	58		43,55	3,2	3,3	23	19	15
	1.88	2.28		1.71	.13	.13	.91	.75	.59
1 7/8-12 UN-2A	54,8	65		49,9	3,2	3,3	23	19	15
	2.16	2.56		1.96	.13	.13	.91	.75	.59

¹ Appendix -2B instead of -2A applies for (female) threaded ports.

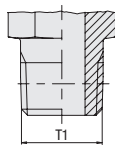
Port Dimensions for Fittings with Male Threaded Stud



Taper Thread

National Pipe Thread (NPT)
ANSI/ASME B1.20.1-1983

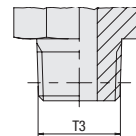

Taper Thread

Metric Taper Thread
DIN 3852-1 (Form C)
Whitworth Taper Pipe Thread
DIN 3852-2 (Form C)

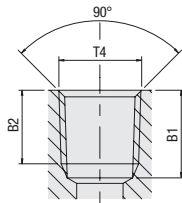

Port (Taper Thread)

for Male Studs with National Pipe NPT Thread
ANSI/ASME B1.20.1-1983

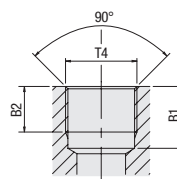

Port (Parallel Thread)

for Male Studs with Metric Taper Thread
DIN 3852-1 (Form Z)
for Male Studs with Whitworth Taper Pipe Thread
DIN 3852-2 (Form Z)

Dimensions

(mm/in)

Thread T1	Thread T3	Thread T4	B1 _{min}	B2 _{min}
1/8-27 NPT		1/8-27 NPT		6,9 .27
1/4-18 NPT		1/4-18 NPT		10 .39
3/8-18 NPT		3/8-18 NPT		10,3 .41
1/2-14 NPT		1/2-14 NPT		13,6 .54
3/4-14 NPT		3/4-14 NPT		14,1 .56
1-11.5 NPT		1-11.5 NPT		16,8 .66
1 1/4-11.5 NPT		1 1/4-11.5 NPT		17,3 .68
1 1/2-11.5 NPT		1 1/2-11.5 NPT		17,3 .68
	M 8 x 1 keg.	M 8 x 1	10 .39	5,5 .22
	M 10 x 1 keg.	M 10 x 1	10 .39	5,5 .22
	M 12 x 1,5 keg.	M 12 x 1,5	13,5 .53	8,5 .33
	M 14 x 1,5 keg.	M 14 x 1,5	13,5 .53	8,5 .33
	M 16 x 1,5 keg.	M 16 x 1,5	13,5 .53	8,5 .33
	M 18 x 1,5 keg.	M 18 x 1,5	13,5 .53	8,5 .33
	M 20 x 1,5 keg.	M 20 x 1,5	15,5 .61	10,5 .41
	M 22 x 1,5 keg.	M 22 x 1,5	15,5 .61	10,5 .41
	R 1/8 keg.	Rp 1/8	8,5 .33	5,5 .22
	R 1/4 keg.	Rp 1/4	12,5 .49	8,5 .33
	R 3/8 keg.	Rp 3/8	12,5 .49	8,5 .33
	R 1/2 keg.	Rp 1/2	16,5 .65	10,5 .41

Suitable liquid / plastic sealant required to achieve leak-tightness.

R



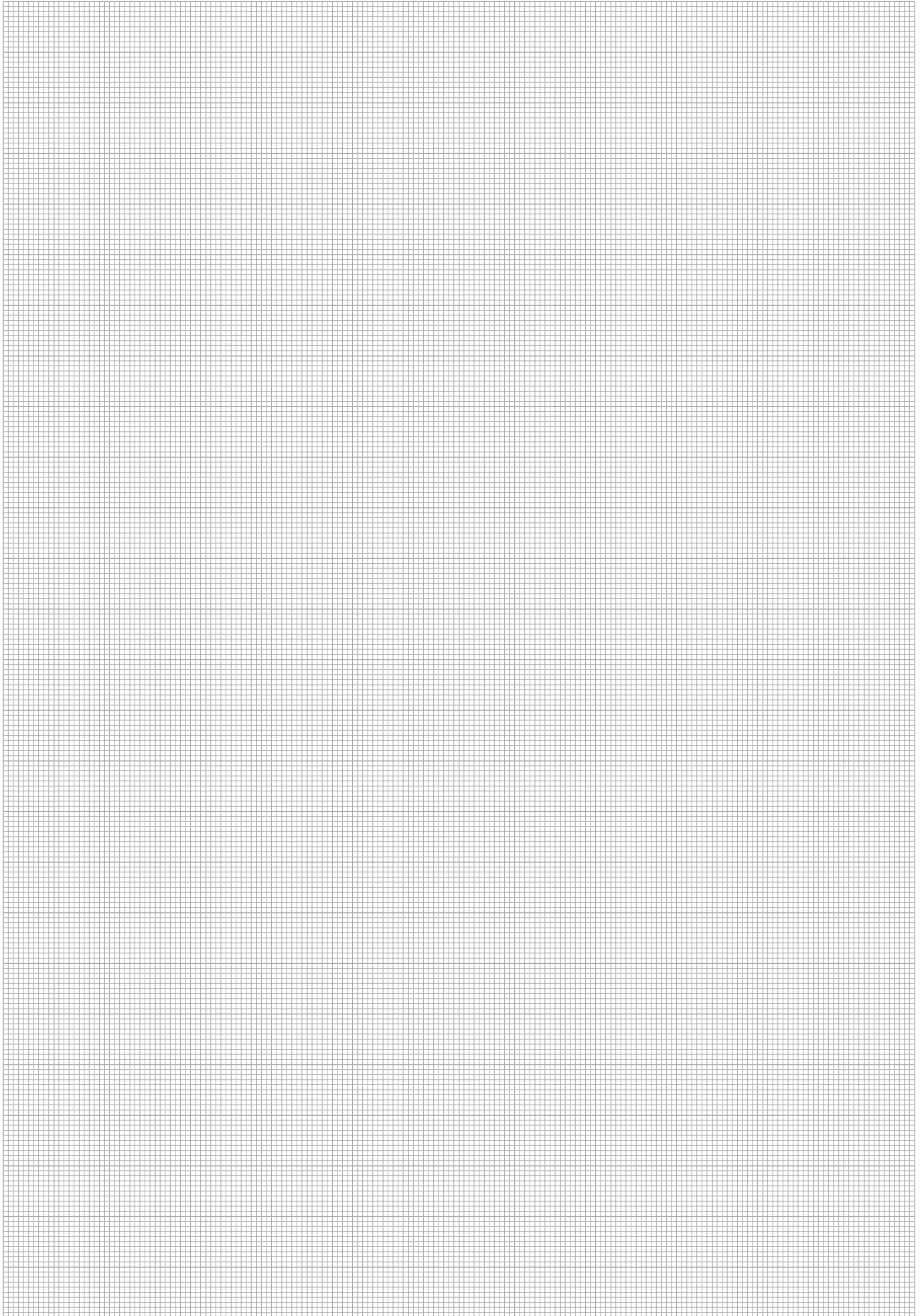

R



Dimensions of the 24° Conical Bore / Union Nut

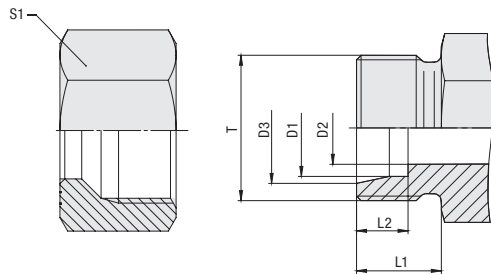

Series	Tube OD		Dimensions						
	(mm/in)	(mm/in)	Thread T	D2	D3	L1	L2	S1	
	D1								
LL	4		M 8 x 1	3	5	8	4	10	
	.16			.12	.20	.31	.16	.39	
	6		M 10 x 1	4,5	7,5	8	5,5	12	
	.24			.18	.30	.31	.22	.47	
LL	8		M 12 x 1	6	9,5	9	5,5	14	
	.31			.24	.37	.35	.22	.55	
L	6		M 12 x 1,5	4	8,1	10	7	14	
	.24			.16	.32	.39	.28	.55	
	8		M 14 x 1,5	6	10,1	10	7	17	
	.31			.24	.40	.39	.28	.67	
	10		M 16 x 1,5	8	12,3	11	7	19	
	.39			.31	.48	.43	.28	.75	
	12		M 18 x 1,5	10	14,3	11	7	22	
	.47			.39	.56	.43	.28	.87	
	15		M 22 x 1,5	12	17,3	12	7	27	
	.59			.47	.68	.47	.28	1.06	
	18		M 26 x 1,5	15	20,3	12	7,5	32	
	.71			.59	.80	.47	.30	1.26	
	22		M 30 x 2	19	24,3	14	7,5	36	
	.87			.75	.96	.55	.30	1.42	
	28		M 36 x 2	24	30,3	14	7,5	41	
	1.10			.94	1.19	.55	.30	1.61	
	35		M 45 x 2	30	38	16	10,5	50	
	1.38			1.18	1.50	.63	.41	1.97	
42		M 52 x 2	36	45	16	11	60		
1.65			1.42	1.77	.63	.43	2.36		
S	6		M 14 x 1,5	4	8,1	12	7	17	
	.24			.16	.32	.47	.28	.67	
	8		M 16 x 1,5	5	10,1	12	7	19	
	.31			.20	.40	.47	.28	.75	
	10		M 18 x 1,5	7	12,3	12	7,5	22	
	.39			.28	.48	.47	.30	.87	
	12		M 20 x 1,5	8	14,3	12	7,5	24	
	.47			.31	.56	.47	.30	.94	
	14 ¹		M 22 x 1,5	10	16,3	14	8	27	
	.55 ¹			.39	.64	.55	.31	1.06	
	16		M 24 x 1,5	12	18,3	14	8,5	30	
	.63			.47	.72	.55	.33	1.18	
	20		M 30 x 2	16	22,9	16	10,5	36	
	.79			.63	.90	.63	.41	1.42	
	25		M 36 x 2	20	27,9	18	12	46	
.98			.79	1.10	.71	.47	1.81		
30		M 42 x 2	25	33	20	13,5	50		
1.18			.98	1.30	.79	.53	1.97		
38		M 52 x 2	32	41	22	16	60		
1.50			1.26	1.61	.87	.63	2.36		

¹ Tube size is no longer covered by the applicable standard.

R



Standard Threads and Widths Across Flats for Fittings with Male Threaded Stud

Series	Tube OD (mm) D1	Male Stud		Male Stud		Union Nut	
		Metric Parallel Thread Thread Size	Width Across Flats	Whitworth Parallel Pipe Thread Thread Size	Width Across Flats	Metric Parallel Thread Thread Size	Width Across Flats
L	6	M 10 x 1	14	G 1/8	14	M 12 x 1,5	14
	.24		.55		.55		.55
	8	M 12 x 1,5	17	G 1/4	19	M 14 x 1,5	17
	.31		.67		.75		.67
	10	M 14 x 1,5	19	G 1/4	19	M 16 x 1,5	19
	.39		.75		.75		.75
	12	M 16 x 1,5	22	G 3/8	22	M 18 x 1,5	22
	.47		.87		.87		.87
	15	M 18 x 1,5	24	G 1/2	27	M 22 x 1,5	27
	.59		.94		1.06		1.06
	18	M 22 x 1,5	27	G 1/2	27	M 26 x 1,5	32
	.71		1.06		1.06		1.26
	22	M 26 x 1,5 ²	32	G 3/4	32	M 30 x 2	36
	.87		1.26		1.26		1.42
28	M 33 x 2	41	G 1	41	M 36 x 2	41	
1.10		1.61		1.61		1.61	
35	M 42 x 2	50	G 1 1/4	50	M 45 x 2	50	
1.38		1.97		1.97		1.97	
42	M 48 x 2	55	G 1 1/2	55	M 52 x 2	60	
1.65		2.17		2.17		2.36	
S	6	M 12 x 1,5	17	G 1/4	19	M 14 x 1,5	17
	.24		.67		.75		.67
	8	M 14 x 1,5	19	G 1/4	19	M 16 x 1,5	19
	.31		.75		.75		.75
	10	M 16 x 1,5	22	G 3/8	22	M 18 x 1,5	22
	.39		.87		.87		.87
	12	M 18 x 1,5	24	G 3/8	22	M 20 x 1,5	24
	.47		.94		.87		.94
	14 ¹	M 20 x 1,5	27	G 1/2	27	M 22 x 1,5	27
	.55 ¹		1.06		1.06		1.06
	16	M 22 x 1,5	27	G 1/2	27	M 24 x 1,5	30
	.63		1.06		1.06		1.18
	20	M 27 x 2	32	G 3/4	32	M 30 x 2	36
	.79		1.26		1.26		1.42
	25	M 33 x 2	41	G 1	41	M 36 x 2	46
	.98		1.61		1.61		1.81
30	M 42 x 2	50	G 1 1/4	50	M 42 x 2	50	
1.18		1.97		1.97		1.97	
38	M 48 x 2	55	G 1 1/2	55	M 52 x 2	60	
1.50		2.17		2.17		2.36	

¹ Tube size is no longer covered by the applicable standard.

² M 27 x 2 according to ISO 6149.

Certificates and Approvals

TYPE APPROVAL CERTIFICATE

DNV-GL

Certificate No:
P-15101
 File No:
792.21
 Job Id:
262.1-016074-2

This is to certify:

That the Pipe Couplings, Bite and Compression Type

with type designation(s)
FI-GE, FI-WE, FI-TE, FI-LE, FI-G, FI-W, FI-T, FI-K, FI-GS, FI-WS, FI-ES, FI-AS, FI-WAS, FI-SN, FI-GA, FI-MA, FI-EMA, FI-EMAD, FI-RSW, FI-RST, FI-EGED, FI-SNV, FI-REDS, FI-EWD, FI-ETD, FI-ELD, FI-EGE, FI-REDS, FI-EW, FI-ET, FI-EL

Issued to

Walter Stauffenberg GmbH & Co. KG
Werdohl, Germany

is found to comply with

Det Norske Veritas' Rules for Classification of Ships Pt.4, Ch.6 "Piping Systems"
Det Norske Veritas' Standards for Certification 2.9 No. 5-792.20

Application :

May be used for: Hydraulic- and lubrication oil, fuel oil, compressed air, oxygen (see cert.), steam and condensate, fresh- and sea water

Temperature range: See certificate
Max. working press.: 100 to 800 bar (see certificate)
Sizes: Tube OD: 4 mm to 42 mm

This Certificate is valid until **2018-12-31**.

Issued at **Høvik** on **2014-11-28**

DNV GL local station: **Essen Business Support**

Approval Engineer: **Tom Berg-Nielsen**

for **DNV GL**
 Digitally Signed By: Saia, Giorgio
 Location: DNV GL Høvik, Norway
 Signing Date: 2014-11-28

Giorgio Saia on behalf of
Marianne Spæren Marveng
Head of Section

This Certificate is subject to terms and conditions overleaf. Any significant change in design or construction may render this Certificate invalid. The validity date relates to the Type Approval Certificate and not to the approval of equipment/systems installed. If any person suffers loss or damage which is proven to have been caused by any negligent act or omission of the Society, then the Society shall pay compensation to such person for his proven direct loss or damage. However, the compensation shall not exceed an amount equal to ten times the fee charged for the service in question. The maximum compensation shall never exceed USD 2 million. In this provision the "Society" shall mean DNV GL AS as well as all its direct and indirect owners, affiliates, subsidiaries, directors, officers, employees, agents and any other person or entity acting on behalf of DNV GL AS.



**BUREAU
VERITAS**

 Marine & Offshore
Division

Certificate number: 42033/A0 BV

File number: ACM 135/2756

Product code: 2130H

This certificate is not valid when presented without the full attached schedule composed of 7 sections
www.veristar.com

TYPE APPROVAL CERTIFICATE

This certificate is issued to
WALTER STAUFFENBERG GmbH & CO. KG

Werdohl - GERMANY

for the type of product
SCREW COUPLINGS

PIPE COUPLINGS, BITE AND COMPRESSION Type Series LL/L/S

Requirements:

BUREAU VERITAS Rules for the Classification of Steel Ships
 BUREAU VERITAS Rules for the Classification of Offshore Units
 BUREAU VERITAS Rules for the Classification of Naval Ships
 BUREAU VERITAS Rules for the Classification of Yachts

This certificate is issued to attest that BUREAU VERITAS did undertake the relevant approval procedures for the product identified above which was found to comply with the relevant requirements mentioned above.

This certificate will expire on: 10 Aug 2020
For BUREAU VERITAS,

At BV HAMBURG, on 10 Aug 2015,

Adama Diene



This certificate remains valid until the date stated above, unless cancelled or revoked, provided the conditions indicated in the subsequent page(s) are complied with and the product remains satisfactory in service. This certificate will not be valid if the applicant makes any changes or modifications to the approved product, which have not been notified to, and agreed in writing with BUREAU VERITAS. Should the specified regulations or standards be amended during the validity of this certificate, the product(s) is/are to be re-approved prior to it/they being placed on board vessels to which the amended regulations or standards apply. This certificate is issued within the scope of the General Conditions of BUREAU VERITAS Marine & Offshore Division available on the internet site www.veristar.com. Any Person not a party to the contract pursuant to which this document is delivered may not assert a claim against BUREAU VERITAS for any liability arising out of errors or omissions which may be contained in said document, or for errors of judgement, fault or negligence committed by personnel of the Society or of its Agents in establishment or issuance of this document, and in connection with any activities for which it may provide.

 The electronic version is available at: <http://www.veristamb.com/veristamb/jsp/viewPublicPdfTypepec.jsp?id=bjbnyaxeyn>

BV Mod. Ad.E 530 October 2014

This certificate consists of 3 page(s)



Certificates and Approvals



Lloyd's Register

Type Approval Certificate

This is to certify that the undernoted product(s) has/have been tested with satisfactory results in accordance with the relevant requirements of the Lloyd's Register Type Approval System.

This certificate is issued to:

PRODUCER	Walter Stauffenberg Im Ehrenfeld 4 58791 Werdohl Germany
DESCRIPTION	Carbon steel (C15, C22, St35, S235JR2 and 11SMnPB30K+C) high pressure 24° compression couplings with or without seals sensitive to heat as per Stauff Catalogue 01/2015,
TYPES	STAUFF LL (very light gauge), L (light gauge) and S (heavy gauge)
APPLICATION	For pressure pipes in the marine, offshore and industrial environment. <u>Restrictions</u> - Bulkhead couplings are not to be used on watertight bulkheads, gastight bulkheads and for "A", "B" fire class divisions. - Couplings with seals sensitive to heat are not acceptable in the following locations : <ol style="list-style-type: none"> 1. Starting/control air and CO₂ systems. 2. Inside machinery spaces of category A or accommodation spaces for :- <ol style="list-style-type: none"> a. Main lines of inert gas systems. b. Pipe systems for flammable liquids including corresponding vent and sounding pipes. 3. Fire main, water spray and sprinkler systems or similar which are not always filled with water.

Certificate No.	15/20081
Issue Date	19 August 2015
Expiry Date	18 August 2020
Sheet	1 of 2

Handwritten signature: Schroeder

Torsten Schroeder
Hamburg Technical Support Office
Lloyd's Register EMEA

Lloyd's Register EMEA
71 Fenchurch Street, London EC3M 4BS

Lloyd's Register EMEA
Is a subsidiary of Lloyd's Register Group

Lloyd's Register Group Limited, its affiliates and subsidiaries and their respective officers, employees or agents are, individually and collectively, referred to in this clause as the 'Lloyd's Register'. Lloyd's Register assumes no responsibility and shall not be liable to any person for any loss, damage or expense caused by reliance on the information or advice in this document or howsoever provided, unless that person has signed a contract with the relevant Lloyd's Register entity for the provision of this information or advice and in that case any responsibility or liability is exclusively on the terms and conditions set out in that contract.

This is a copy of an electronic document. In the event of any conflict or ambiguity between the copy and the electronic document, which is retained and published by Lloyd's Register, the original electronic and certified version shall always prevail.

R



РОССИЙСКИЙ МОРСКОЙ РЕГИСТР СУДОХОДСТВА
 RUSSIAN MARITIME REGISTER OF SHIPPING

6.8.3



СВИДЕТЕЛЬСТВО О ТИПОВОМ ОДОБРЕНИИ
 TYPE APPROVAL CERTIFICATE

Изготовитель
 Manufacturer

Walter Stauffenberg GmbH & Co. KG GmbH

Адрес
 Address

Im Ehrenfeld 4, 58791 Werdohl, Germany.

Изделие*
 Product*

Трубные муфтовые и обжимные соединения типов:
 FI-GE, FI-WE, FI-TE, FI-LE, FI-G, FI-W, FI-T, FI-K, FI-GS, FI-WS, FI-ES, FI-AS,
 FI-WAS, FI-SN, FI-GA, FI-MA, FI-EMA, FI-EMAD, FI-RSW, FI-RST, FI-EGED,
 FI-SNV, FI-RESD, FI-EWD, FI-ETD, FI-ELD, FI-EGE, FI-REDS, FI-EW, FI-ET, FI-EL.

Pipe couplings, bite and compression type:
 FI-GE, FI-WE, FI-TE, FI-LE, FI-G, FI-W, FI-T, FI-K, FI-GS, FI-WS, FI-ES, FI-AS,
 FI-WAS, FI-SN, FI-GA, FI-MA, FI-EMA, FI-EMAD, FI-RSW, FI-RST, FI-EGED,
 FI-SNV, FI-RESD, FI-EWD, FI-ETD, FI-ELD, FI-EGE, FI-REDS, FI-EW, FI-ET, FI-EL.

Код номенклатуры 08030710
 Code of nomenclature

На основании освидетельствования и проведенных испытаний удостоверяется, что вышеупомянутое(ые) изделие(я) удовлетворяет(ют) требованиям Российского морского регистра судоходства.
 This is to certify that on the basis of the survey and tests carried out the above mentioned item(s) complies(ly) with the requirements of Russian Maritime Register of Shipping.

Часть VIII Системы и трубопроводы "Правил классификации и постройки морских судов" (2015).
 Part VIII Systems and piping of "Rules for the Classification and construction of Sea-Going Ships" (2015).

Настоящее Свидетельство о типовом одобрении действительно до 18.03.2020
 This Type Approval Certificate is valid until

Настоящее Свидетельство о типовом одобрении теряет силу в случаях, установленных в Правилах технического наблюдения за постройкой судов и изготовлением материалов и изделий для судов.

This Type Approval Certificate becomes invalid in cases stipulated in Rules for the Technical Supervision during Construction of Ships and Manufacture of Shipboard Materials and Products.

Дата выдачи 18.03.2015
 Date of issue

№ 15.40023.250

Российский морской регистр судоходства
 Russian Maritime Register of Shipping



(подпись)
 signature)

Морозов В.В. / V. Morozov

(фамилия, инициалы)
 name

*Дополнительную информацию смотри на обороте.
 Additional information see overleaf.





Product-Specific Abbreviations	300
---------------------------------------	------------

Global Contact Directory	302
---------------------------------	------------



Product-Specific Abbreviations

Abbreviation	Product Category	Product Description	Page
FI-AB	Connecting Parts	37° Flared Tube Fitting Set	35
FI-AR	Connecting Parts	STAUFF Form Adaptor Ring	30
FI-AS	Weld Fittings	Straight Weld Fitting	98
FI-ASV	Weld Fittings	Straight Weld Fitting for Tubes	104
FI-BA	Connecting Parts	24°/37° Flared Cone Adaptor with O-Rings	32
FI-BH	Connecting Parts	Support Sleeve for 37° Flared Tube Fittings	33
FI-BM	Connecting Parts	Union Nut for 37° Flared Tube Fittings	34
FI-BUZ	Spare Parts / Accessories	Blanking Plug with Sealing Edge	203
FI-DGWESV-...-M-WD	Swivel Fittings	Swivel Elbow with Metric Parallel Thread / Profile Sealing Ring	173
FI-DGWESV-...-R-WD	Swivel Fittings	Swivel Elbow with Whitworth Parallel Pipe Thread (BSPP) / Profile Sealing Ring	172
FI-DIR	Spare Parts / Accessories	Retaining Ring with Captive Seal	213
FI-DKI	Spare Parts / Accessories	Internal Metallic Sealing Ring	214
FI-DKR	Spare Parts / Accessories	External Metallic Sealing Ring	212
FI-DS	Connecting Parts	Double Edge Cutting Ring	26
FI-EGE-...-M	Standpipe Fittings	Straight Male Stud Standpipe Fitting with Metric Parallel Thread / Metallic Sealing Edge	133
FI-EGE-...-M-WD	Standpipe Fittings	Straight Male Stud Standpipe Fitting with Metric Parallel Thread / Profile Sealing Ring	135
FI-EGE-...-N	Standpipe Fittings	Straight Male Stud Standpipe Fitting with NPT Thread	136
FI-EGE-...-R	Standpipe Fittings	Straight Male Stud Standpipe Fitting with Whitworth Parallel Pipe Thread (BSPP) / Metallic Sealing Edge	132
FI-EGE-...-R-WD	Standpipe Fittings	Straight Male Stud Standpipe Fitting with Whitworth Parallel Pipe Thread (BSPP) / Profile Sealing Ring	134
FI-EGED-...-M-WD	Female Stud / Gauge Fittings	Straight Male Stud Fitting with 24° Taper / O-Ring with Metric Parallel Thread / Profile Sealing Ring	117
FI-EGED-...-R-WD	Female Stud / Gauge Fittings	Straight Male Stud Fitting with 24° Taper / O-Ring with Whitworth Parallel Pipe Thread (BSPP) / Profile Sealing Ring	116
FI-EL	Standpipe Fittings	Adjustable Standpipe Barrel Tee	144
FI-ELD	Fittings with 24° Taper / O-Ring (DKO)	Adjustable Barrel Tee with 24° Taper / O-Ring	129
FI-EMA-...-R	Female Stud / Gauge Fittings	Gauge Standpipe Fitting with Female Whitworth Parallel Pipe Thread (BSPP) / Internal Metallic Sealing Ring	113
FI-EMAD-...-R	Female Stud / Gauge Fittings	Gauge Fitting with 24° Taper / O-Ring and Female Whitworth Parallel Pipe Thread (BSPP) / Internal Metallic Sealing Ring	112
FI-ES	Bulkhead Fittings	Straight Bulkhead Weld Fitting	94
FI-ET	Standpipe Fittings	Adjustable Standpipe Branch Tee	143
FI-ETD	Fittings with 24° Taper / O-Ring (DKO)	Adjustable Branch Tee with 24° Taper / O-Ring	128
FI-EVD	Fittings with 24° Taper / O-Ring (DKO)	Adjustable Elbow (45°) with 24° Taper / O-Ring	127
FI-EW	Standpipe Fittings	Adjustable Standpipe Elbow	142
FI-EWD	Fittings with 24° Taper / O-Ring (DKO)	Adjustable Elbow (90°) with 24° Taper / O-Ring	126
FI-FB	Assembly Tools / Devices	STAUFF Form Clamping Jaws	239
FI-FK	Assembly Tools / Devices	Manual Cutting Ring Final Assembly Stud	218
FI-FST	Assembly Tools / Devices	STAUFF Form Tube Shapers	238
FI-G	Tube Fittings / Unions	Straight Union	82
FI-G	Tube Fittings / Unions	Straight Reducer	83
FI-GA-...-M	Female Stud / Gauge Fittings	Straight Female Stud Fitting with Female Metric Parallel Thread	109
FI-GA-...-N	Female Stud / Gauge Fittings	Straight Female Stud Fitting with NPT Thread	110
FI-GA-...-R	Female Stud / Gauge Fittings	Straight Female Stud Fitting with Female Whitworth Parallel Pipe Thread (BSPP)	108
FI-GE-...-M	Male Stud Fittings	Straight Male Stud Fitting with Metric Parallel Thread / Metallic Sealing Edge	42
FI-GE-...-Mk	Male Stud Fittings	Straight Male Stud Fitting with Metric Taper Thread	56
FI-GE-...-M-OR	Male Stud Fittings	Straight Male Stud Fitting with Metric Parallel Thread / O-Ring	52
FI-GE-...-M-WD	Male Stud Fittings	Straight Male Stud Fitting with Metric Parallel Thread / Profile Sealing Ring	48
FI-GE-...-N	Male Stud Fittings	Straight Male Stud Fitting with NPT Thread	58
FI-GE-...-R	Male Stud Fittings	Straight Male Stud Fitting with Whitworth Parallel Pipe Thread (BSPP) / Metallic Sealing Edge	38
FI-GE-...-R-DF	Male Stud Fittings	Straight Male Stud Fitting with BSPP Thread / 60° Conical Bore / Sealing Surface for Gaskets	50
FI-GE-...-RK	Male Stud Fittings	Straight Male Stud Fitting with Whitworth Taper Pipe Thread (BSPT)	54
FI-GE-...-R-WD	Male Stud Fittings	Straight Male Stud Fitting with Whitworth Parallel Pipe Thread (BSPP) / Profile Sealing Ring	44
FI-GE-...-U	Male Stud Fittings	Straight Male Stud Fitting with UN/UNF / Thread O-Ring	60
FI-GP	Assembly Tools / Devices	Support Plate for Machine-Assisted Assembly	223
FI-GP-PRC	Assembly Tools / Devices	Support Plate for Machine-Assisted Assembly	228
FI-GS	Bulkhead Fittings	Straight Bulkhead Fitting	92
FI-ID	Assembly Tools / Devices	STAUFF Form Internal Tube Supports	238
FI-K	Tube Fittings / Unions	Equal Cross	89
FI-KB	Assembly Tools / Devices	Clamping Jaws for 37° Flaring	229
FI-KR	Spare Parts / Accessories	Retaining Ring (Small)	215
FI-LE-...-M	Male Stud Fittings	Male Stud Barrel Tee with Metric Parallel Thread / Metallic Sealing Edge	75
FI-LE-...-Mk	Male Stud Fittings	Male Stud Barrel Tee with Metric Taper Thread	77
FI-LE-...-N	Male Stud Fittings	Male Stud Barrel Tee with NPT Thread	78
FI-LE-...-R	Male Stud Fittings	Male Stud Barrel Tee with Whitworth Parallel Pipe Thread (BSPP) / Metallic Sealing Edge	74
FI-LE-...-RK	Male Stud Fittings	Male Stud Barrel Tee with Whitworth Taper Pipe Thread (BSPT)	76
FI-LEE-...-M-OK	Fittings with Lock Nut	Adjustable Male Stud Barrel Tee with Lock Nut and Metric Parallel Thread / O-Ring and Retaining Ring (Small)	151
FI-LEE-...-M-OR	Fittings with Lock Nut	Adjustable Male Stud Barrel Tee with Lock Nut and Metric Parallel Thread / O-Ring	153
FI-LEE-...-R-OK	Fittings with Lock Nut	Adjustable Male Stud Barrel Tee with Lock Nut and Whitworth Parallel Pipe Thread (BSPP) / O-Ring and Retaining Ring (Small)	149
FI-LEE-...-U-OR	Fittings with Lock Nut	Adjustable Male Stud Barrel Tee with Lock Nut and UN/UNF Thread / O-Ring	155
FI-M	Connecting Parts	Union Nut	31
FI-MA-...-R	Female Stud / Gauge Fittings	Gauge Fitting with Female Whitworth Parallel Pipe Thread (BSPP) / Gauge Fitting with Internal Metallic Sealing Ring	111
FI-MFK	Assembly Tools / Devices	Assembly Stud for Machine-Assisted Assembly	222
FI-MVK-...-PRC	Assembly Tools / Devices	Cutting Ring Assembly Stud for Machine-Assisted Assembly	227
FI-MVK-...-PRC-H-M	Assembly Tools / Devices	Cutting Ring Assembly Stud for Machine-Assisted Assembly	232
FI-RED-...-R	Spare Parts / Accessories	Thread Reducer with Whitworth Parallel Pipe Thread (BSPP) / Metallic Sealing Edge	194
FI-RED-...-R-WD	Spare Parts / Accessories	Thread Reducer with Whitworth Parallel Pipe Thread (BSPP) / Profile Sealing Ring	192
FI-REDS	Standpipe Fittings	Straight Standpipe Reducer	138
FI-REDS	Fittings with 24° Taper / O-Ring (DKO)	Straight Reducer for Tube Ends with 24° Taper / O-Ring	122
FI-RST-...-M-DK	Banjo Fittings	Banjo Tee (High-Pressure Version) with Metric Parallel Thread / External Metallic Sealing Ring	167
FI-RST-...-M-WD	Banjo Fittings	Banjo Tee (High-Pressure Version) with Metric Parallel Thread / Retaining Ring with Captive Seal	169
FI-RST-...-R-DK	Banjo Fittings	Banjo Tee (High-Pressure Version) with Whitworth Parallel Pipe Thread (BSPP) / External Metallic Sealing Ring	166
FI-RST-...-R-WD	Banjo Fittings	Banjo Tee (High-Pressure Version) with Whitworth Parallel Pipe Thread (BSPP) / Retaining Ring with Captive Seal	168



Product-Specific Abbreviations

Abbreviation	Product Category	Product Description	Page
FI-RSW-...-M-DK	Banjo Fittings	Banjo Elbow (High-Pressure Version) with Metric Parallel Thread / External Metallic Sealing Ring	163
FI-RSW-...-M-WD	Banjo Fittings	Banjo Elbow (High-Pressure Version) with Metric Parallel Thread / Retaining Ring with Captive Seal	165
FI-RSW-...-R-DK	Banjo Fittings	Banjo Elbow (High-Pressure Version) with Whitworth Parallel Pipe Thread (BSPP) / External Metallic Sealing Ring	162
FI-RSW-...-R-WD	Banjo Fittings	Banjo Elbow (High-Pressure Version) with Whitworth Parallel Pipe Thread (BSPP) / Retaining Ring with Captive Seal	164
FI-RSWND-...-M-DK	Banjo Fittings	Banjo Elbow (Medium-Pressure Version) with Metric Parallel Thread / External Metallic Sealing Ring	159
FI-RSWND-...-M-WD	Banjo Fittings	Banjo Elbow (Medium-Pressure Version) with Metric Parallel Thread / Retaining Ring with Captive Seal	161
FI-RSWND-...-R-DK	Banjo Fittings	Banjo Elbow (Medium-Pressure Version) with Whitworth Parallel Pipe Thread (BSPP) / External Metallic Sealing Ring	158
FI-RSWND-...-R-WD	Banjo Fittings	Banjo Elbow (Medium-Pressure Version) with Whitworth Parallel Pipe Thread (BSPP) / Retaining Ring with Captive Seal	160
FI-RV	Hydraulic Valves	Check Valve	176
FI-RVI-...-R	Hydraulic Valves	Female Stud Check Valve with Female Whitworth Parallel Pipe Thread (BSPP)	182
FI-RVW-...-M-WD	Hydraulic Valves	Male Stud Check Valve (Flow from Stud End) with Metric Parallel Thread / Profile Sealing Ring	179
FI-RVW-...-R-WD	Hydraulic Valves	Male Stud Check Valve (Flow from Stud End) with Whitworth Parallel Pipe Thread (BSPP) / Profile Sealing Ring	178
FI-RVZ-...-M-WD	Hydraulic Valves	Male Stud Check Valve (Flow to Stud End) with Metric Parallel Thread / Profile Sealing Ring	181
FI-RVZ-...-R-WD	Hydraulic Valves	Male Stud Check Valve (Flow to Stud End) with Whitworth Parallel Pipe Thread (BSPP) / Profile Sealing Ring	180
FI-S	Connecting Parts	Single Edge Cutting Ring	26
FI-SKM	Spare Parts / Accessories	Hexagon Lock Nut	205
FI-SN	Weld Fittings	24° Weld Cone with O-Ring	100
FI-SNR	Weld Fittings	24° Weld Cone Reducer with O-Ring	102
FI-SNV	Fittings with 24° Taper / O-Ring (DKO)	Straight Fitting with 24° Taper / O-Ring	118
FI-SNV	Fittings with 24° Taper / O-Ring (DKO)	Straight Reducer with 24° Taper / O-Ring	120
FI-T	Tube Fittings / Unions	Equal Tee	86
FI-T	Tube Fittings / Unions	Tee Reducer	87
FI-TE-...-M	Male Stud Fittings	Male Stud Branch Tee with Metric Parallel Thread / Metallic Sealing Edge	69
FI-TE-...-Mk	Male Stud Fittings	Male Stud Branch Tee with Metric Taper Thread	71
FI-TE-...-N	Male Stud Fittings	Male Stud Branch Tee with NPT Thread	72
FI-TE-...-R	Male Stud Fittings	Male Stud Branch Tee with Whitworth Parallel Pipe Thread (BSPP) / Metallic Sealing Edge	68
FI-TE-...-Rk	Male Stud Fittings	Male Stud Branch Tee with Whitworth Taper Pipe Thread (BSPT)	70
FI-TEE-...-M-OK	Fittings with Lock Nut	Adjustable Male Stud Branch Tee with Lock Nut and Metric Parallel Thread / O-Ring and Retaining Ring (Small)	151
FI-TEE-...-M-OR	Fittings with Lock Nut	Adjustable Male Stud Branch Tee with Lock Nut and Metric Parallel Thread / O-Ring	153
FI-TEE-...-R-OK	Fittings with Lock Nut	Adjustable Male Stud Branch Tee with Lock Nut and Whitworth Parallel Pipe Thread (BSPP) / O-Ring and Retaining Ring (Small)	149
FI-TEE-...-U-OR	Fittings with Lock Nut	Adjustable Male Stud Branch Tee with Lock Nut and UN/UNF Thread / O-Ring	155
FI-TIB	Assembly Tools / Devices	Thread Identification Board	242
FI-VD	Spare Parts / Accessories	Blanking Plug with 24° Taper / O-Ring (DKO)	202
FI-VEE-...-M-OK	Fittings with Lock Nut	Adjustable Male Stud Elbow (45°) with Lock Nut with Metric Parallel Thread / O-Ring and Retaining Ring (Small)	151
FI-VEE-...-M-OR	Fittings with Lock Nut	Adjustable Male Stud Elbow (45°) with Lock Nut with Metric Parallel Thread / O-Ring	153
FI-VEE-...-R-OK	Fittings with Lock Nut	Adjustable Male Stud Elbow (45°) with Lock Nut with Whitworth Parallel Pipe Thread (BSPP) / O-Ring and Retaining Ring (Small)	149
FI-VEE-...-U-OR	Fittings with Lock Nut	Adjustable Male Stud Elbow (45°) with Lock Nut with UN/UNF Thread / O-Ring	155
FI-VES	Hydraulic Valves	Check Valve Installation Kit	183
FI-VH	Connecting Parts	Support Sleeve	28
FI-VK	Assembly Tools / Devices	Manual Cutting Ring Pre-Assembly Stud	219
FI-VS-...-M-OR	Spare Parts / Accessories	Blanking Screw for Ports with Metric Parallel Thread / O-Ring	201
FI-VS-...-M-WD	Spare Parts / Accessories	Blanking Screw for Ports with Metric Parallel Thread / Profile Sealing Ring	199
FI-VS-...-R	Spare Parts / Accessories	Blanking Screw for Ports with Whitworth Parallel Pipe Thread (BSPP) / Metallic Sealing Edge	200
FI-VS-...-R-WD	Spare Parts / Accessories	Blanking Screw for Ports with Whitworth Parallel Pipe Thread (BSPP) / Profile Sealing Ring	198
FI-VSK	Spare Parts / Accessories	Blanking Plug for Tube Ends	204
FI-VSV-...-M-WD	Spare Parts / Accessories	Blanking Screw for Ports (Heavy Duty) with Metric Parallel Thread / Profile Sealing Ring	197
FI-VSV-...-R-WD	Spare Parts / Accessories	Blanking Screw for Ports (Heavy Duty) with Whitworth Parallel Pipe Thread (BSPP) / Profile Sealing Ring	196
FI-W	Tube Fittings / Unions	Equal Elbow	85
FI-WAS	Weld Fittings	Elbow Weld Fitting	99
FI-WDDS	Connecting Parts	Soft-Sealing Cutting Ring	27
FI-WE-...-M	Male Stud Fittings	Male Stud Elbow with Metric Parallel Thread / Metallic Sealing Edge	63
FI-WE-...-Mk	Male Stud Fittings	Male Stud Elbow with Metric Taper Thread	65
FI-WE-...-N	Male Stud Fittings	Male Stud Elbow with NPT Thread	66
FI-WE-...-R	Male Stud Fittings	Male Stud Elbow with Whitworth Parallel Pipe Thread (BSPP) / Metallic Sealing Edge	62
FI-WE-...-Rk	Male Stud Fittings	Male Stud Elbow with Whitworth Taper Pipe Thread (BSPT)	64
FI-WEE-...-M-OK	Fittings with Lock Nut	Adjustable Male Stud Elbow (90°) with Metric Parallel Thread / O-Ring and Retaining Ring (Small)	150
FI-WEE-...-M-OR	Fittings with Lock Nut	Adjustable Male Stud Elbow (90°) with Metric Parallel Thread / O-Ring	152
FI-WEE-...-R-OK	Fittings with Lock Nut	Adjustable Male Stud Elbow (90°) with Lock Nut and Whitworth Parallel Pipe Thread (BSPP) / O-Ring and Retaining Ring (Small)	148
FI-WEE-...-U-OR	Fittings with Lock Nut	Adjustable Male Stud Elbow (90°) with UN/UNF Thread / O-Ring	154
FI-WS	Bulkhead Fittings	Elbow Bulkhead Fitting	93
FI-WV	Hydraulic Valves	Alternating Valve	184
O-RING	Spare Parts / Accessories	O-Ring	207
SC	Assembly Tools / Devices	STAUFF Clean Pipe, Tube and Hose Cleaning System	238
SFO-F	Assembly Tools / Devices	STAUFF Form Tube Forming Machine	236
SPR-PRC-HS	Assembly Tools / Devices	External Hand Control Switch	226
SPR-PRC-H-SET	Assembly Tools / Devices	Portable Cutting Ring Assembly Machine with Manual Pressure Setting (Set)	230
SPR-PRC-MA	Assembly Tools / Devices	Cutting Ring Pre-Assembly and 37° Flaring Machine	224
SPR-PRC-POC	Assembly Tools / Devices	Cutting Ring Pre-Assembly and Final Assembly Machine	220
SPR-PRC-TH	Assembly Tools / Devices	Tooling Heads for Cutting Ring Pre-Assembly / 37° Flaring	226
SPR-PRC-TH-C-A	Assembly Tools / Devices	Tooling Head for Cutting Ring Assembly (Automatic)	226
SPR-PRC-TH-C-M	Assembly Tools / Devices	Tooling Head for Cutting Ring Assembly (Manual)	226
SPR-PRC-TH-F-M	Assembly Tools / Devices	Tooling Head for 37° Flaring Machine (Manual)	226
SPR-TM	Assembly Tools / Devices	Assembly Tool Magazine	226
WDG	Spare Parts / Accessories	Profile Sealing Ring	206



Global Contact Directory

STAUFF products and services are globally available through wholly-owned subsidiaries and a tight network of authorised distributors and representatives in all major industrial regions of the world.

Contact information on this page may be subject to changes and additions over time. Frequently updated and complete contact information can always be found at www.stauff.com.

Germany



Walter Stauffenberg GmbH & Co. KG

Im Ehrenfeld 4
58791 Werdohl
Tel.: +49 2392 91 60
Fax: +49 2392 91 61 03
E-Mail: sales@stauff.com
www.stauff.com



Neuenrade-Küntrop Logistics Centre
Wasserburgstraße 35
58809 Neuenrade



Plettenberg-Ohle Production Site
Lennastraße 2
58840 Plettenberg



Meinerzhagen Production Site
Neugrünenthal
58540 Meinerzhagen

Europe

France

STAUFF S.A.S.
230, Avenue du Grain d'Or
Z.I. de Vineuil - Blois Sud
41354 Vineuil-cedex
Tel.: +33 2 54 50 55 50
Fax: +33 2 54 42 29 19
E-Mail: direction@stauffsa.com
www.stauff.fr

Ireland

STAUFF UK Ltd.
Block B, 9 Ferguson Drive
Knockmore Hill Industrial Estate
Lisburn, County Antrim, BT28 2EX
Tel.: +44 2892 60 69 00
Fax: +44 2892 60 26 88
E-Mail: sales@stauffireland.com
www.stauff.co.uk

Italy

STAUFF Italia s.r.l.
Via Borima 21 (Frazione Borima)
23867 Suello (LC)
Tel.: +39 031 65 84 94
Fax: +39 031 65 50 05
E-Mail: sales@stauff.it
www.stauff.it

Poland

STAUFF Polska Sp. z o.o.
Miszewko 43 A
80-297 Banino
Tel.: +48 58 660 11 60
Fax: +48 58 629 79 52
E-Mail: sales@stauff.pl
www.stauff.pl

Russian Federation

STAUFF LLC
Building 1
19, Leninskaya Sloboda
Moscow, 115280
Tel.: +7 495 276 16 50
Fax: +7 495 276 16 51
E-Mail: sales@stauff.ru
www.stauff.ru

United Kingdom

STAUFF UK Ltd.
500, Carlisle Street East
Off Downgate Drive
Sheffield, S4 8BS
Tel.: +44 114 251 85 18
Fax: +44 114 251 85 19
E-Mail: sales@stauff.co.uk
www.stauff.co.uk

STAUFF UK Ltd.
Badentoy Avenue
Badentoy Industrial Estate
Portlethen, Aberdeen, AB12 4YB
Tel.: +44 1224 78 61 66
Fax: +44 1224 78 61 77
E-Mail: sales@stauffscotland.co.uk
www.stauff.co.uk

STAUFF UK Ltd.
Unit 9, Southampton Trade Park
Third Avenue, Millbrook
Southampton, SO15 0AD
Tel.: +44 2380 69 87 00
Fax: +44 2380 69 87 01
E-Mail: sales@stauffsouthampton.co.uk
www.stauff.co.uk

Further branch offices in
Engels, Volzhskiy, Magnitogorsk,
Nizhny Novgorod and St. Petersburg.

North America

Canada

STAUFF Canada Ltd.
866 Milner Avenue
Scarborough
Ontario M1B 5N7
Tel.: +1 416 282 46 08
Fax: +1 416 282 30 39
E-Mail: sales@stauffcanada.com
www.stauffcanada.com

United States

STAUFF Corporation
7 Wm. Demarest Place
Waldwick, 07463-1542
New Jersey
Tel.: +1 201 444 78 00
Fax: +1 201 444 78 52
E-Mail: sales@stauffusa.com
www.stauffusa.com

Further branch office in
Canton, Michigan.

South America

Brazil

STAUFF Brasil Ltda.
Avenida Gupê 10767
Galpão 2 - Bloco A
Barueri, São Paulo, CEP 06422-120
Tel.: +55 11 47 72 72 00
Fax: +55 11 47 72 72 10
E-Mail: stauff@stauffbrasil.com
www.stauffbrasil.com



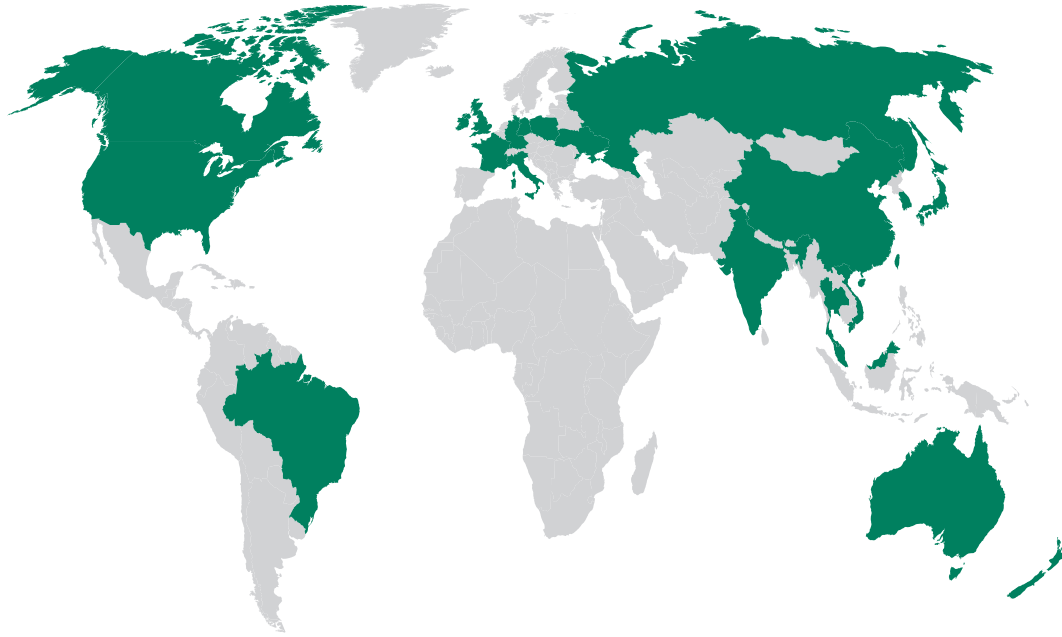

Asia

China

STAUFF CHINA

Building 1, No. 128, Die Qiao Road
Jushuo Industrial Zone, Kang Qiao
Shanghai, 201319
Tel.: +86 21 68 18 70 00
Fax: +86 21 68 18 71 36
E-Mail: info@stauff.com.cn
www.stauff.com.cn

Further branch offices in Beijing,
Changsha, Chengdu, Changchun,
Chongqing, Jinan, Harbin, Guangzhou,
Shenyang, Wuhan, Xian and Xuzhou.

India

STAUFF India Pvt. Ltd.

Gat no. 26/1 & 27, Sanghar Warehousing
Pune - Nagar Road
Lonikand - 412216
Tel.: +91 20 6731 4900
Fax: +91 20 6731 4905
E-Mail: sales@stauffindia.com
www.stauffindia.com

Korea

STAUFF Korea Ltd.

105, Hwajeonsandan 5-ro
Gangseo-gu
Busan, 46739
Tel.: +82 51 266 6666
Fax: +82 51 266 8866
E-Mail: info@stauff.co.kr
www.stauff.co.kr

Malaysia

STAUFF South East Asia Sdn Bhd

No. 8, Jalan SS13/6A
Subang Jaya Industrial Estate
47500 Subang Jaya
Tel.: +60 3 5637 78 88
Fax: +60 3 5636 78 90
E-Mail: sales@stauff.com.my
www.stauff.com.my

Thailand

STAUFF (Thailand) Co., Ltd.

10 Soi On-Nut 74/4
Pravet District
Bangkok 10250
Tel.: +66 2 721 73 23 / 24
Fax: +66 2 721 73 35
E-Mail: sales@stauff.co.th
www.stauff.co.th

Vietnam

STAUFF Vietnam Ltd.

2nd Floor, CT-IN Building
#435 Hoang Van Thu Street
Tan Binh District, Ho Chi Minh City
Tel.: +84 8 3948 10 41 / 42
Fax: +84 8 3948 10 44
E-Mail: sales@stauff.com.vn
www.stauff.com.vn

Oceania

Australia

STAUFF Corporation Pty Ltd

24-26 Doyle Avenue
Unanderra NSW 2526
Tel.: +61 2 4271 9000
Fax: +61 2 4271 8432
E-Mail: sales@stauff.com.au
www.stauff.com.au

Further branch offices in
Adelaide, Brisbane, Melbourne
and Sydney.

New Zealand

STAUFF Corporation (NZ) Ltd.

Unit D, 103 Harris Road
East Tamaki, Auckland 2013
Tel.: +64 9 271 48 12
Fax: +64 9 271 48 32
E-Mail: sales@stauff.co.nz
www.stauff.co.nz



Introduction

System Overview

Connecting Parts

Male Stud Fittings

Tube Fittings / Unions

Bulkhead Fittings

Weld Fittings

Female Stud / Gauge Fittings

Fittings with 24° Taper / O-Ring (DKO)

Standpipe Fittings

Fittings with Lock Nut

Banjo Fittings

Swivel Fittings

Hydraulic Valves

Custom-Designed Solutions

Spare Parts / Accessories

Assembly Tools / Devices

Assembly Instructions

Technical Appendix

Appendix



Catalogue 2 STAUFF Connect

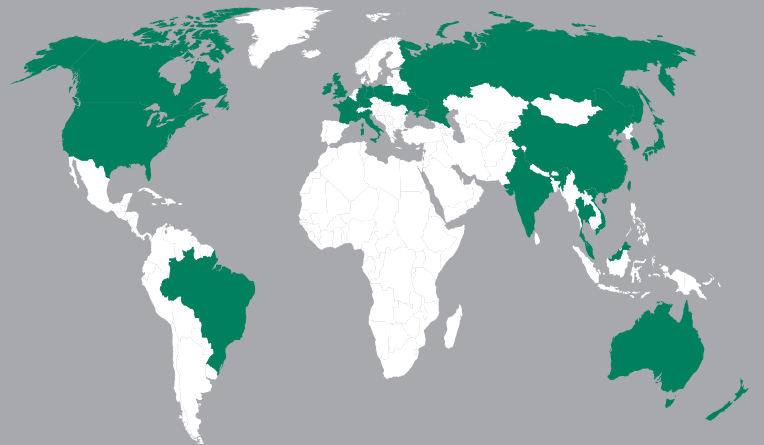

Germany

Walter Stauffenberg GmbH & Co. KG
Im Ehrenfeld 4
58791 Werdohl
Tel.: +49 2392 91 60
Fax: +49 2392 91 61 03
E-Mail: sales@stauff.com

STAUFF products and services are globally available through wholly-owned subsidiaries and a tight network of authorised distributors and representatives in all major industrial regions of the world.

You can find detailed contact information on the last two pages of this product catalogue or at

www.stauff.com